

Silicon N-Channel MOSFET Triode

- For high-frequency stages up to 300 MHz preferably in FM applications
- $I_{DSS} = 4\text{mA}$, $g_{fs} = 12\text{mS}$

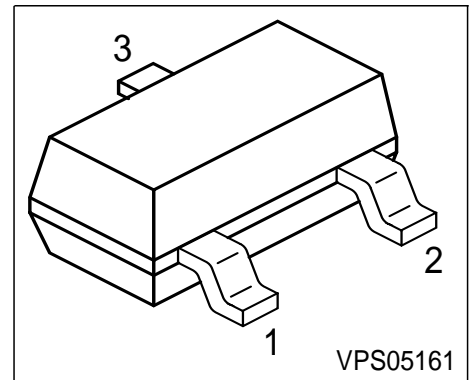

ESD: Electrostatic discharge sensitive device, observe handling precaution!

Type	Marking	Pin Configuration			Package
BF543	LDs	1 = G	2 = D	3 = S	SOT23

Maximum Ratings

Parameter	Symbol	Value	Unit
Drain-source voltage	V_{DS}	20	V
Drain current	I_D	30	mA
Gate-source peak current	$\pm I_{GSM}$	10	
Total power dissipation, $T_S \leq 76\text{ }^\circ\text{C}$	P_{tot}	200	mW
Storage temperature	T_{stg}	-55 ... 150	$^\circ\text{C}$
Ambient temperature range	T_A	-55 ... 150	
Channel temperature	T_{ch}	150	

Thermal Resistance

Channel - soldering point ¹⁾	R_{thchs}	≤ 370	K/W
---	-------------	------------	-----

¹For calculation of R_{thJA} please refer to Application Note Thermal Resistance

Electrical Characteristics at $T_A = 25\text{ }^\circ\text{C}$, unless otherwise specified.

Parameter	Symbol	Values			Unit
		min.	typ.	max.	
DC characteristics					
Drain-source breakdown voltage $I_D = 10\text{ }\mu\text{A}$, $-V_{GS} = 4\text{ V}$	$V_{(BR)DS}$	20	-	-	V
Gate-source breakdown voltage $\pm I_{GS} = 10\text{ mA}$, $V_{DS} = 0$	$\pm V_{(BR)GSS}$	7	-	12	
Gate-source leakage current $\pm V_{GS} = 6\text{ V}$, $V_{DS} = 0$	$\pm I_{GSS}$	-	-	50	nA
Drain current $V_{DS} = 10\text{ V}$, $V_{GS} = 0$	I_{DSS}	2	4	6	mA
Gate-source pinch-off voltage $V_{DS} = 10\text{ V}$, $I_D = 20\text{ }\mu\text{A}$	$-V_{GS(p)}$	-	0.7	1.5	V
AC characteristics					
Forward tranconductance $V_{DS} = 10\text{ V}$, $I_D = 4\text{ mA}$	g_{fs}	9.5	12	-	mS
Gate input capacitance $V_{DS} = 10\text{ V}$, $I_D = 4\text{ mA}$, $f = 1\text{ MHz}$	C_{gss}	-	2.7	-	pF
Reverse tranfer capacitance $V_{DS} = 10\text{ V}$, $I_D = 4\text{ mA}$, $f = 1\text{ MHz}$	C_{dg}	-	18	-	fF
Output capacitance $V_{DS} = 10\text{ V}$, $I_D = 4\text{ mA}$, $f = 1\text{ MHz}$	C_{dss}	-	0.9	-	pF
Power gain (test circuit) $G_G = 2\text{ mS}$, $G_L = 0,5\text{ mS}$ $V_{DS} = 10\text{ V}$, $I_D = 4\text{ mA}$, $f = 200\text{ MHz}$	G_p	-	22	-	dB
Noise figure (test circuit) $G_G = 2\text{ mS}$, $G_L = 0,5\text{ mS}$ $V_{DS} = 10\text{ V}$, $I_D = 4\text{ mA}$, $f = 200\text{ MHz}$	F	-	1	-	

Total power dissipation $P_{tot} = f(T_S)$

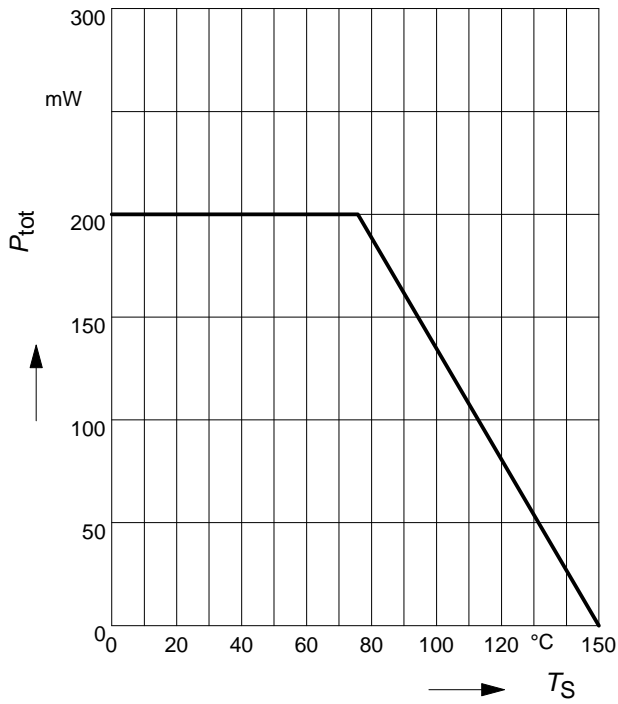

Output characteristics $I_D = f(V_{DS})$

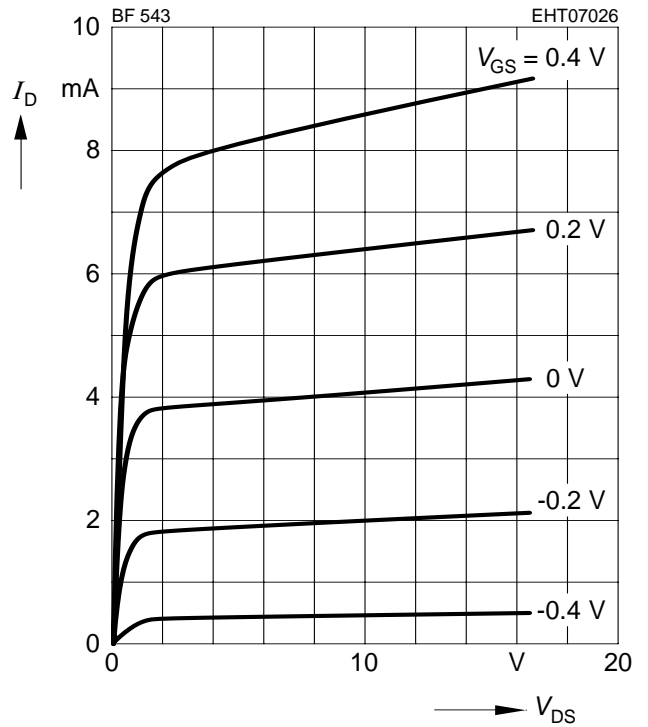

Gate transconductance $g_{fs} = f(V_{GS})$

$V_{DS} = 10$, $I_{DSS} = 4$ mA, $f = 1$ kHz

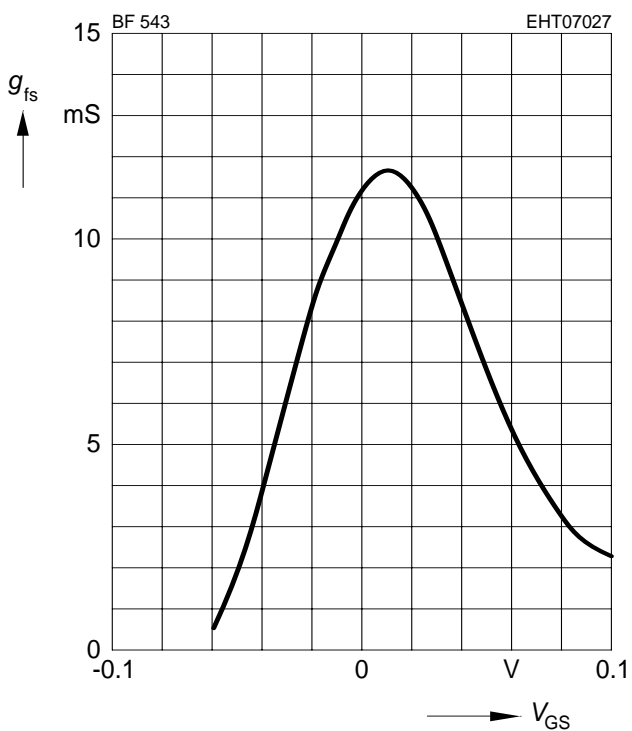

Drain current $I_D = f(V_{GS})$

$V_{DS} = 10$ V

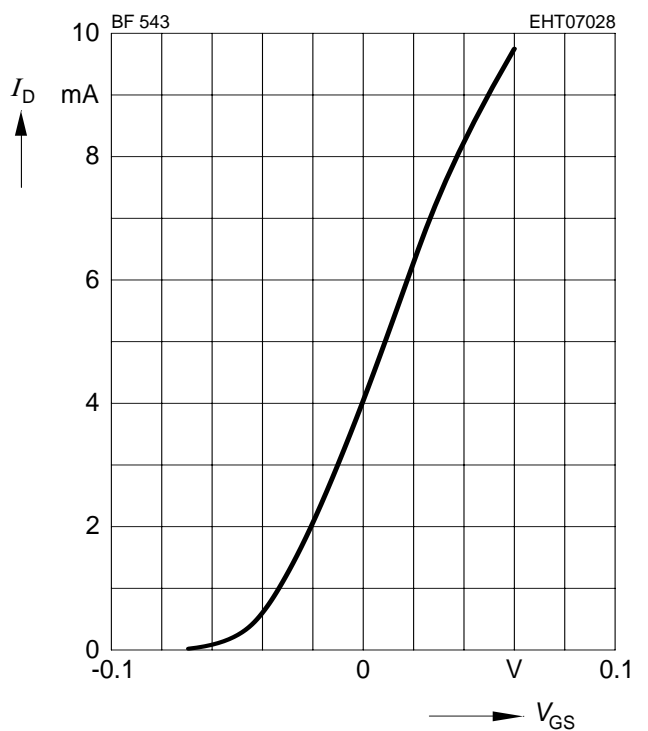

Gate input capacitance $C_{gss} = f(V_{GS})$

$V_{DS} = 10, I_{DSS} = 4mA, f = 1MHz$

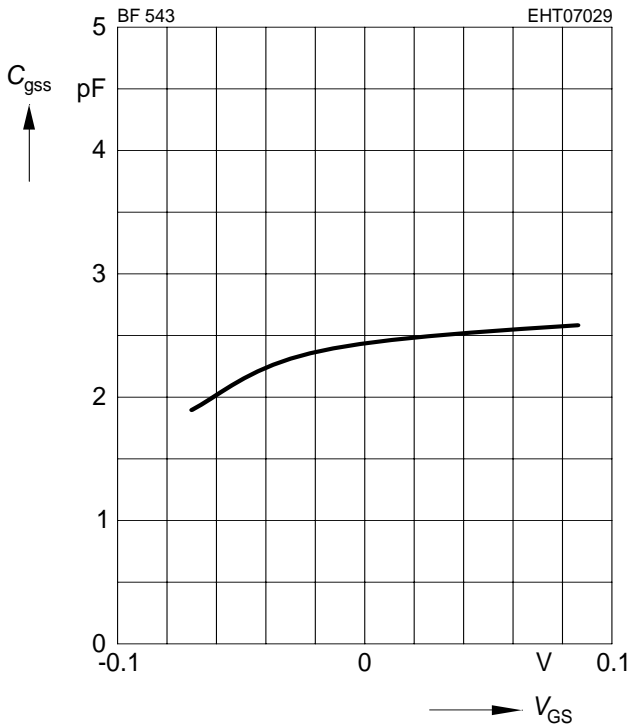

Output capacitance $C_{dss} = f(V_{DS})$

$V_{GS} = 0, I_{DSS} = 4mA, f = 1MHz$

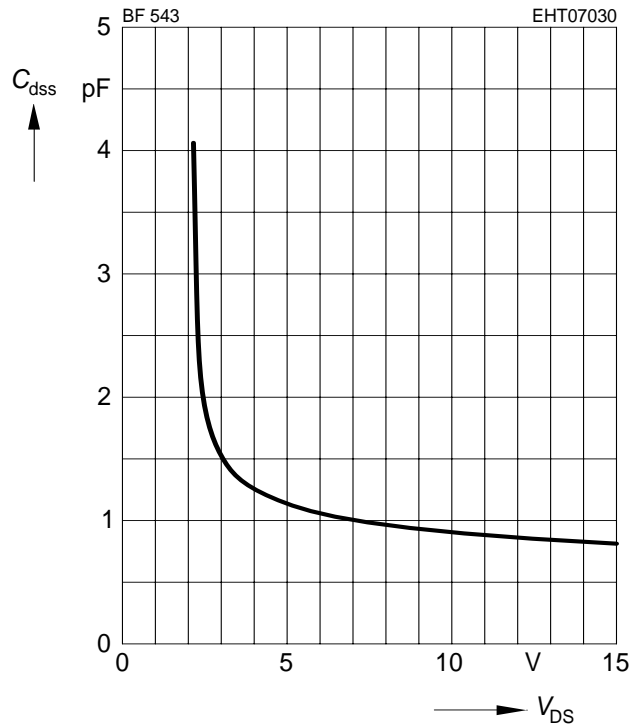

Reverse transfer capacitance

$C_{dg} = f(V_{DS})$

$V_{GS} = 0, I_{DSS} = 4mA, f = 1MHz$

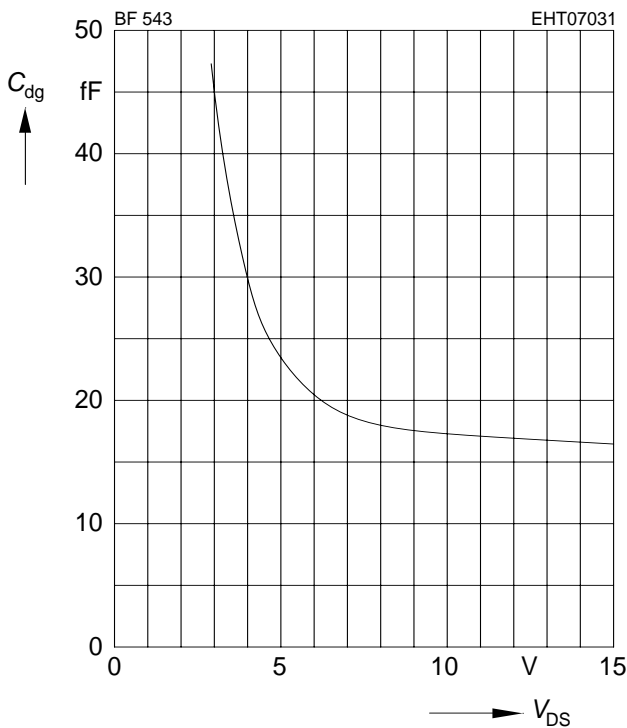

Gate input admittance y_{11s}

$V_{DS} = 10, I_{DSS} = 4mA, V_{GS} = 0$

(source circuit)

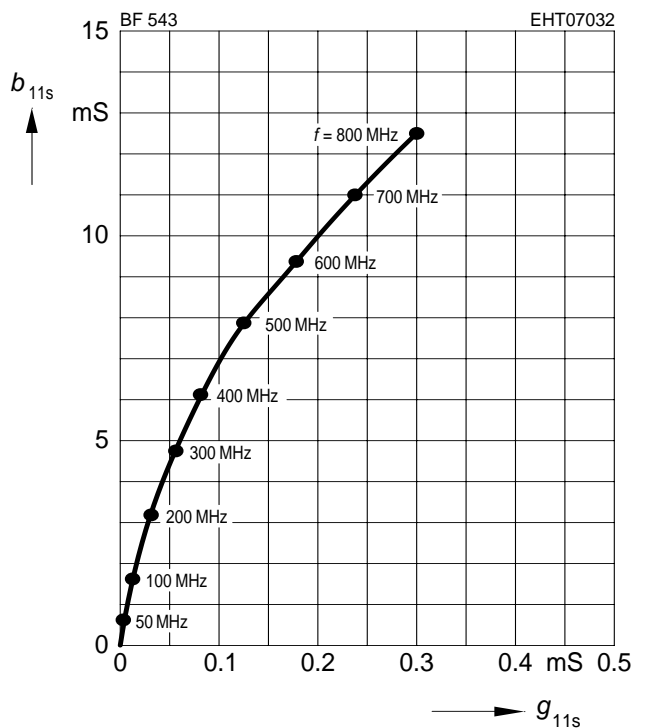

Gate forward transfer admittance y_{21s}

$V_{DS} = 10V, I_{DSS} = 4mA, V_{GS} = 0$

(source circuit)

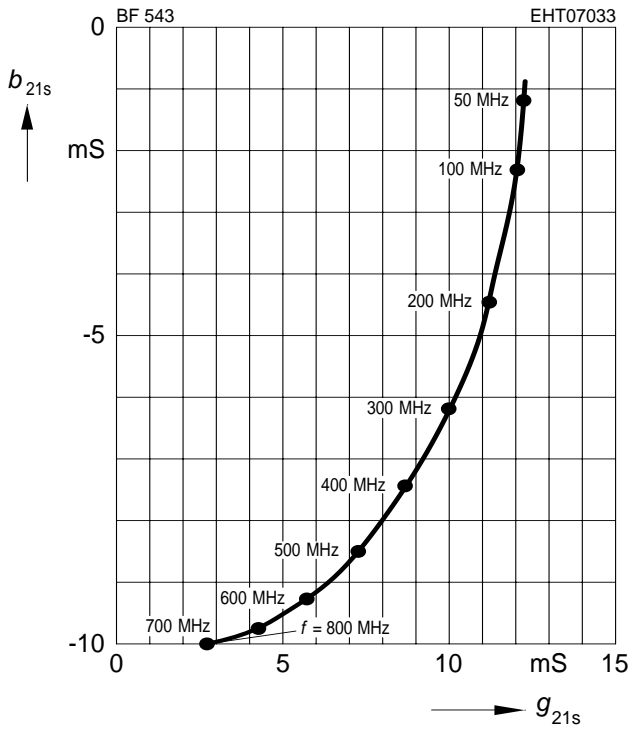

Output admittance y_{22s}

$V_{DS} = 10V, I_{DSS} = 10mA, V_{GS} = 0$

(source circuit)

