

**Silicon Switching Diode Array**

- Bridge configuration
- High-speed switching diode chip

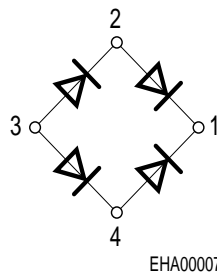
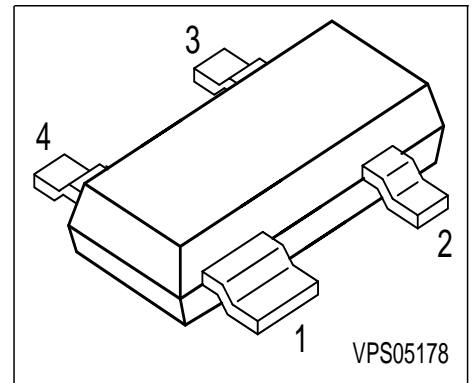

Type	Marking	Pin Configuration				Package
BGX50A	U1s	1=C1/C2	2=A1/C4	3=A3/A4	4=A2/C3	SOT143

**Maximum Ratings**

Parameter	Symbol	Value	Unit
Diode reverse voltage	$V_R$	50	V
Peak reverse voltage	$V_{RM}$	70	
Forward current	$I_F$	140	mA
Total power dissipation, $T_S = 74\text{ °C}$	$P_{tot}$	210	mW
Junction temperature	$T_j$	150	°C
Storage temperature	$T_{stg}$	65 ... 150	

**Thermal Resistance**

Junction - soldering point <sup>1)</sup>	$R_{thJS}$	≤ 360	K/W
--	------------	-------	-----

<sup>1)</sup>For calculation of  $R_{thJA}$  please refer to Application Note Thermal Resistance

**Electrical Characteristics** at  $T_A = 25^\circ\text{C}$ , unless otherwise specified.

Parameter	Symbol	Values			Unit
		min.	typ.	max.	
<b>DC characteristics</b>					
Forward voltage $I_F = 100\text{ mA}$	$V_F$	-	-	1.3	V
Reverse current $V_R = 50\text{ V}$	$I_R$	-	-	0.2	$\mu\text{A}$
Reverse current $V_R = 50\text{ V}, T_A = 150^\circ\text{C}$	$I_R$	-	-	100	
<b>AC characteristics</b>					
Diode capacitance $V_R = 0\text{ V}, f = 1\text{ MHz}$	$C_D$	-	-	1.5	pF
Reverse recovery time $I_F = 10\text{ mA}, I_R = 10\text{ mA}, R_L = 100\ \Omega$ , measured at $I_R = 1\text{ mA}$	$t_{rr}$	-	-	6	ns

**Test circuit for reverse recovery time**

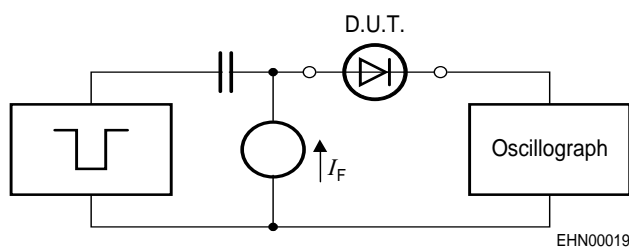

Pulse generator:  $t_p = 100\text{ ns}$ ,  $D = 0.05$ ,  
 $t_r = 0.6\text{ ns}$ ,  $R_i = 50\ \Omega$

Oscilloscope:  $R = 50\ \Omega$ ,  $t_r = 0.35\text{ ns}$ ,  
 $C \leq 1\text{ pF}$

Forward current  $I_F = f(T_S)$

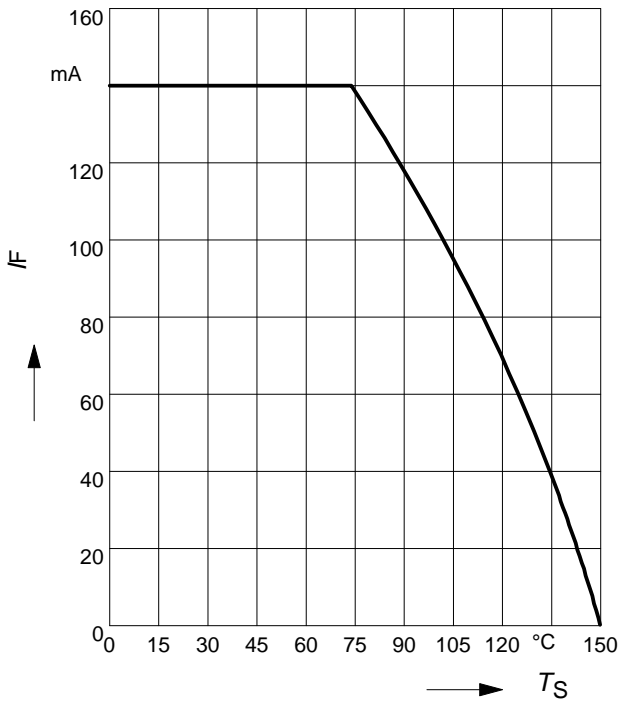

Reverse current  $I_R = f(T_A)$

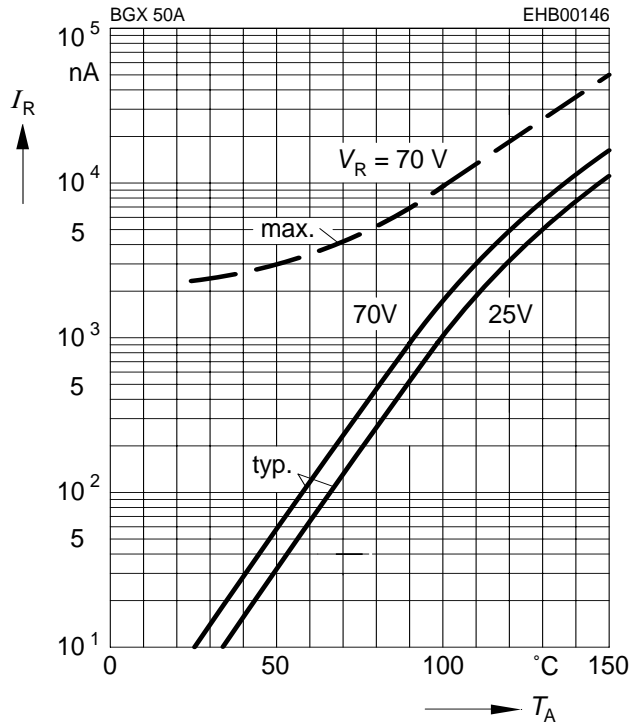

Forward current  $I_F = f(V_F)$

$T_A = 25^\circ\text{C}$

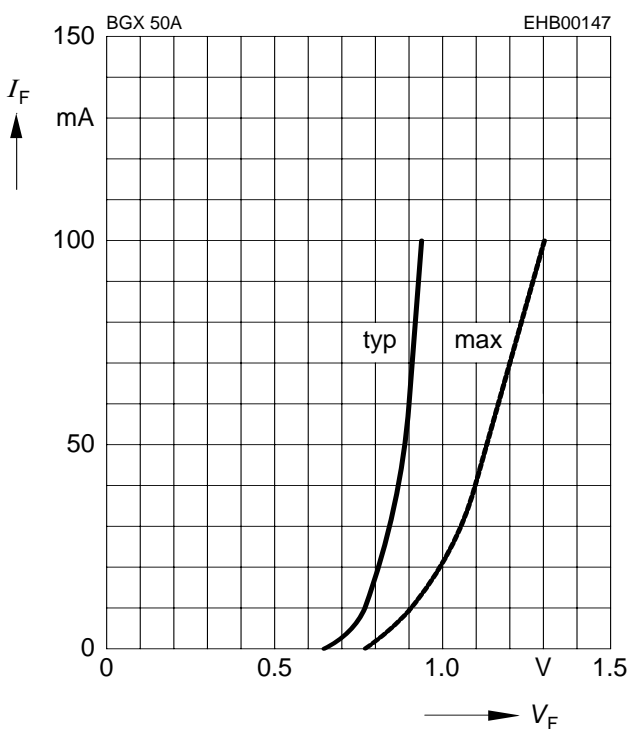

Peak forward current  $I_{FM} = f(t_p)$

$T_A = 25^\circ\text{C}$

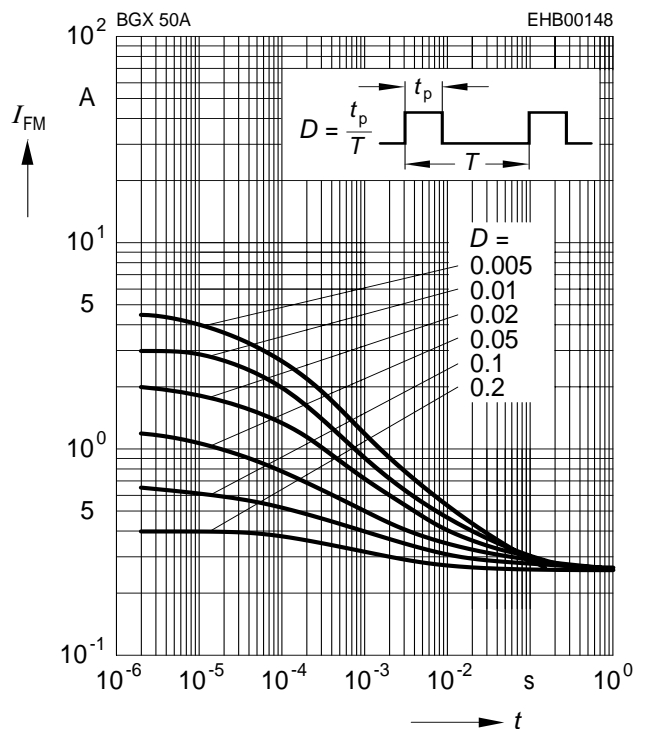

Forward voltage  $V_F = f(T_A)$

