

DATA SHEET

BLW90 UHF power transistor

Product specification

August 1986

UHF power transistor

BLW90

DESCRIPTION

N-P-N silicon planar epitaxial transistor suitable for transmitting applications in class-A, B or C in the u.h.f. and v.h.f. range for a nominal supply voltage of 28 V. The transistor is resistance stabilized and is guaranteed to withstand infinite VSWR at rated output power. High reliability is ensured by a **gold sandwich metallization**.

The transistor is housed in a 1/4" capstan envelope with a ceramic cap. All leads are isolated from the stud.

QUICK REFERENCE DATA

R.F. performance up to $T_h = 25\text{ }^\circ\text{C}$ in an unneutralized common-emitter class-B circuit

MODE OF OPERATION	V_{CE} V	f MHz	P_L W	G_p dB	η %
c.w.	28	470	4	> 11	> 55

PIN CONFIGURATION

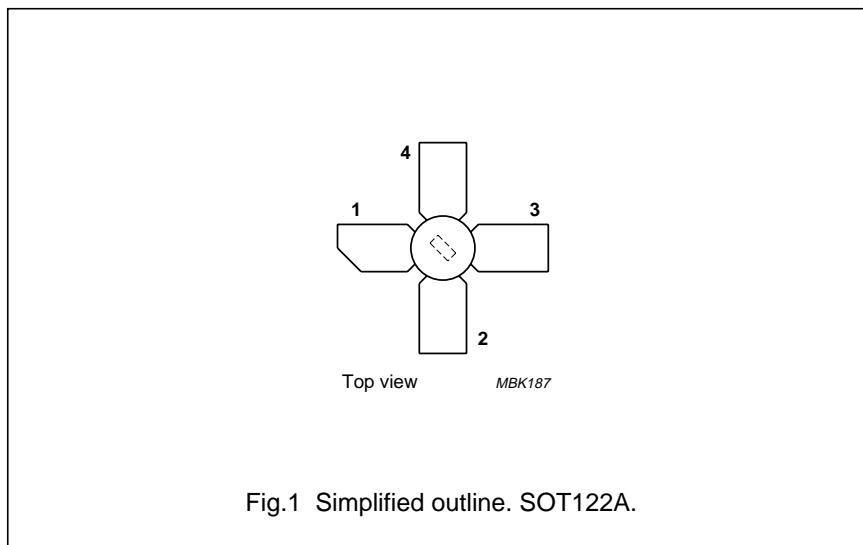

PINNING - SOT122A.

PIN	DESCRIPTION
1	collector
2	emitter
3	base
4	emitter

PRODUCT SAFETY This device incorporates beryllium oxide, the dust of which is toxic. The device is entirely safe provided that the BeO disc is not damaged.

UHF power transistor

BLW90

RATINGS

Limiting values in accordance with the Absolute Maximum System (IEC 134)

Collector-emitter voltage

(peak value); $V_{BE} = 0$

open base

V_{CESM} max. 60 V

V_{CEO} max. 30 V

Emitter-base voltage (open collector)

V_{EBO} max. 4 V

Collector current

d.c. or average

$I_C; I_{C(AV)}$ max. 0,62 A

(peak value); $f > 1$ MHz

I_{CM} max. 2,0 A

Total power dissipation (d.c. and r.f.) up to $T_{mb} = 25$ °C

P_{tot} max. 18,6 W

Storage temperature

T_{stg} -65 to + 150 °C

Operating junction temperature

T_j max. 200 °C

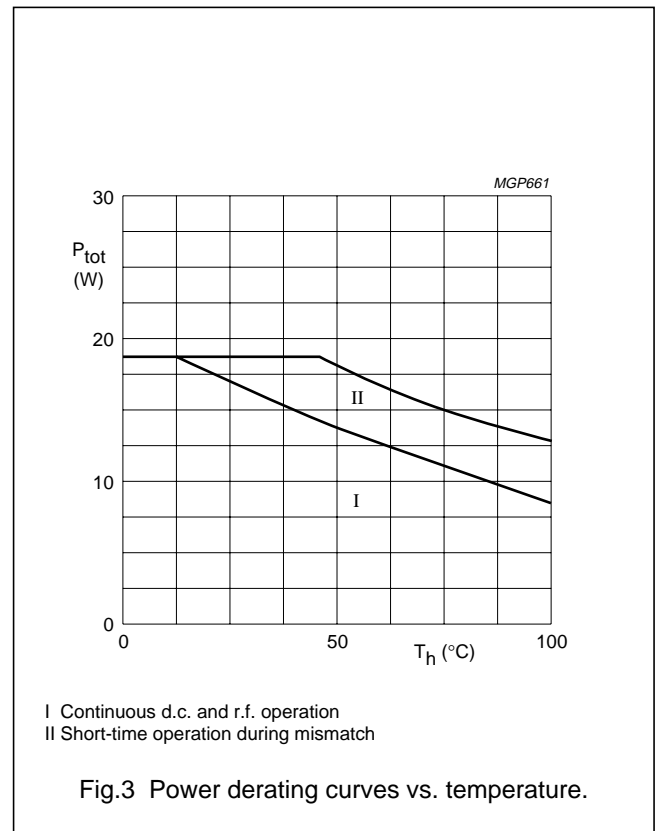
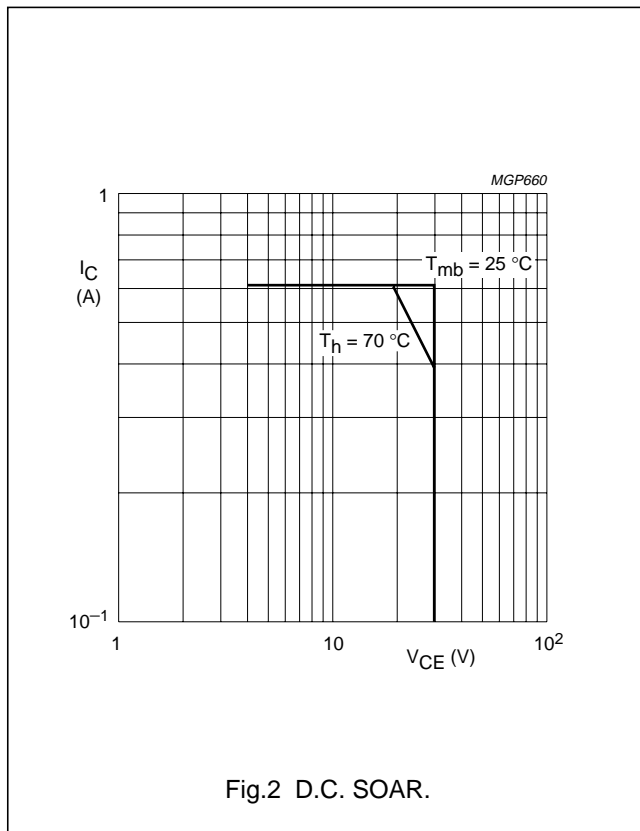

THERMAL RESISTANCE

(dissipation = 6 W; $T_{mb} = 73,6$ °C, i.e. $T_h = 70$ °C)

From junction to mounting base

(d.c. and r.f. dissipation)

$R_{th\ j-mb}$ = 9,0 K/W

From mounting base to heatsink

$R_{th\ mb-h}$ = 0,6 K/W

UHF power transistor

BLW90

CHARACTERISTICS $T_j = 25\text{ °C}$

Collector-emitter breakdown voltage

 $V_{BE} = 0; I_C = 4\text{ mA}$ $V_{(BR)CES} > 60\text{ V}$

Collector-emitter breakdown voltage

open base; $I_C = 20\text{ mA}$ $V_{(BR)CEO} > 30\text{ V}$

Emitter-base breakdown voltage

open collector; $I_E = 2\text{ mA}$ $V_{(BR)EBO} > 4\text{ V}$

Collector cut-off current

 $V_{BE} = 0; V_{CE} = 30\text{ V}$ $I_{CES} < 2\text{ mA}$ Second breakdown energy; $L = 25\text{ mH}; f = 50\text{ Hz}$

open base

 $E_{SBO} > 1\text{ mJ}$ $R_{BE} = 10\ \Omega$ $E_{SBR} > 1\text{ mJ}$ D.C. current gain ⁽¹⁾ $I_C = 0,3\text{ A}; V_{CE} = 5\text{ V}$ h_{FE} typ. 40
10 to 100Collector-emitter saturation voltage ⁽¹⁾ $I_C = 1,0\text{ A}; I_B = 0,2\text{ A}$ V_{CEsat} typ. 0,9 VTransition frequency at $f = 500\text{ MHz}$ ⁽¹⁾ $-I_E = 0,3\text{ A}; V_{CB} = 28\text{ V}$ f_T typ. 1,2 GHz $-I_E = 1,0\text{ A}; V_{CB} = 28\text{ V}$ f_T typ. 0,9 GHzCollector capacitance at $f = 1\text{ MHz}$ $I_E = I_e = 0; V_{CB} = 28\text{ V}$ C_c typ. 8,4 pFFeedback capacitance at $f = 1\text{ MHz}$ $I_C = 20\text{ mA}; V_{CE} = 28\text{ V}$ C_{re} typ. 3,6 pF

Collector-stud capacitance

 C_{cs} typ. 1,2 pF**Note**1. Measured under pulse conditions: $t_p \leq 200\ \mu\text{s}; \delta \leq 0,02$.

UHF power transistor

BLW90

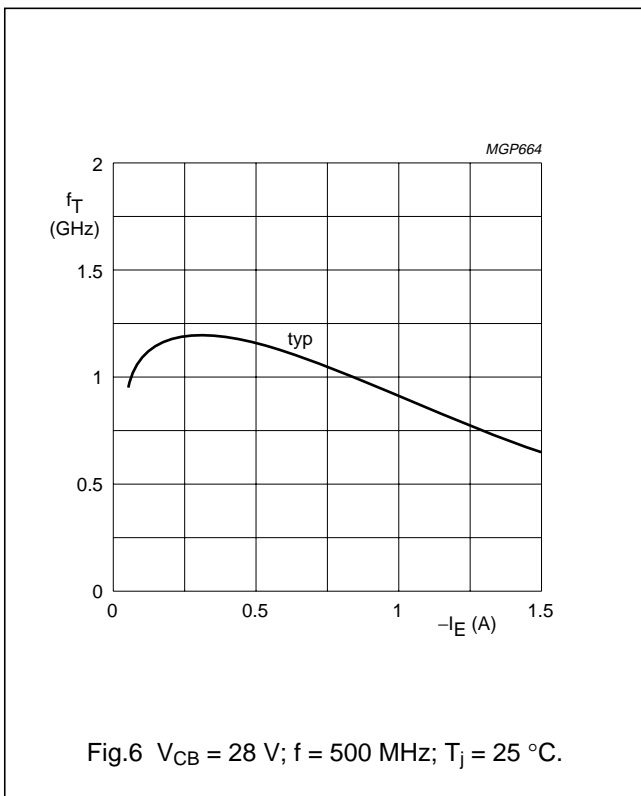
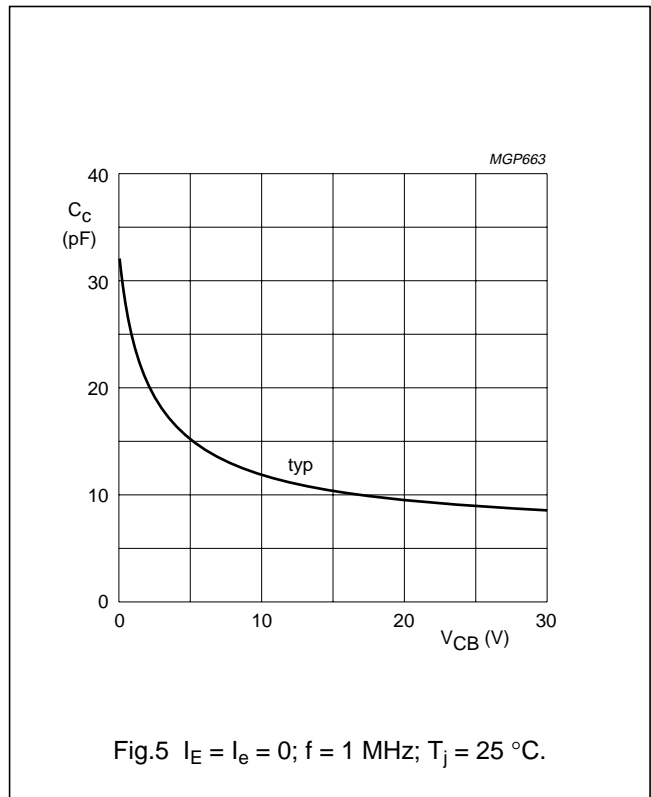
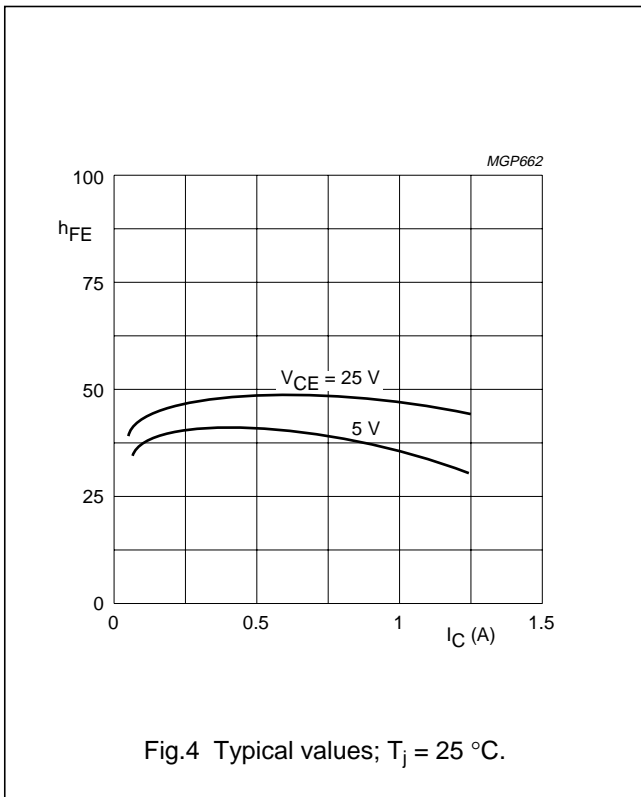

UHF power transistor

BLW90

APPLICATION INFORMATION

R.F. performance in c.w. operation (unneutralized common-emitter class-B circuit); $T_h = 25\text{ }^\circ\text{C}$

f (MHz)	V_{CE} (V)	P_L (W)	P_S (W)	G_p (dB)	I_C (A)	η (%)	\bar{Z}_i (Ω)	\bar{Z}_L (Ω)
470	28	4	< 0,32	> 11	< 0,26	> 55	$1,7 + j1,8$	$8 + j26$
470	28	4	typ. 0,23	typ. 12,5	typ. 0,25	typ. 58	–	–

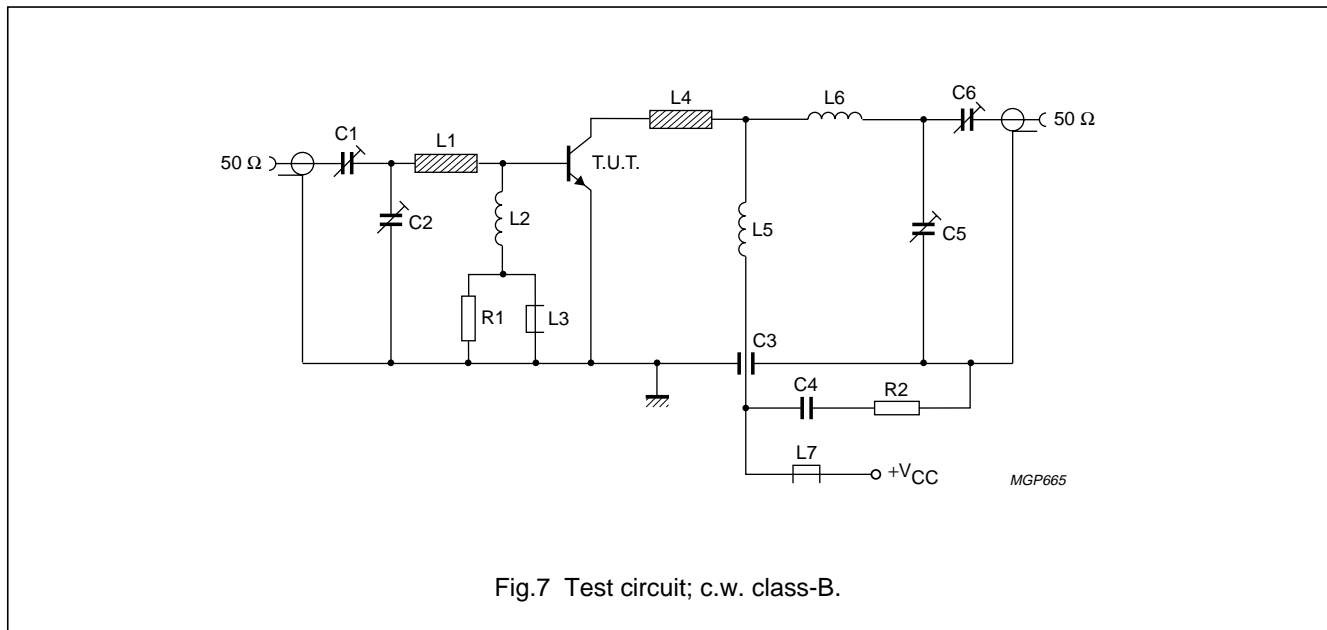

Fig.7 Test circuit; c.w. class-B.

List of components:

- C1 = C5 = C6 = 1,4 to 5,5 pF film dielectric trimmer (cat. no. 2222 809 09001)
- C2 = 2 to 9 pF film dielectric trimmer (cat. no. 2222 809 09002)
- C3 = 100 pF feed-through capacitor
- C4 = 100 nF polyester capacitor
- L1 = stripline (34,8 mm \times 6,0 mm)
- L2 = 320 nH; 13 turns closely wound enamelled Cu wire (0,5 mm); int. dia. 4 mm; leads 2 \times 4 mm
- L3 = L7 = Ferroxcube wide-band h.f. choke, grade 3B (cat. no. 4312 020 36640)
- L4 = stripline (12,0 mm \times 6,0 mm)
- L5 = 265 nH; 13 turns closely wound enamelled Cu wire (0,35 mm); int. dia. 3,5 mm; leads 2 \times 4 mm
- L6 = 29 nH; 3 turns closely wound enamelled Cu wire (1 mm); int. dia. 3,5 mm; leads 2 \times 4 mm
- L1 and L4 are striplines on a double Cu-clad printed-circuit board with PTFE fibre-glass dielectric ($\epsilon_r = 2,74$); thickness 1/16".
- R1 = 100 Ω carbon resistor
- R2 = 10 Ω carbon resistor

Component layout and printed-circuit board for 470 MHz test circuit are shown in Fig.8.

UHF power transistor

BLW90

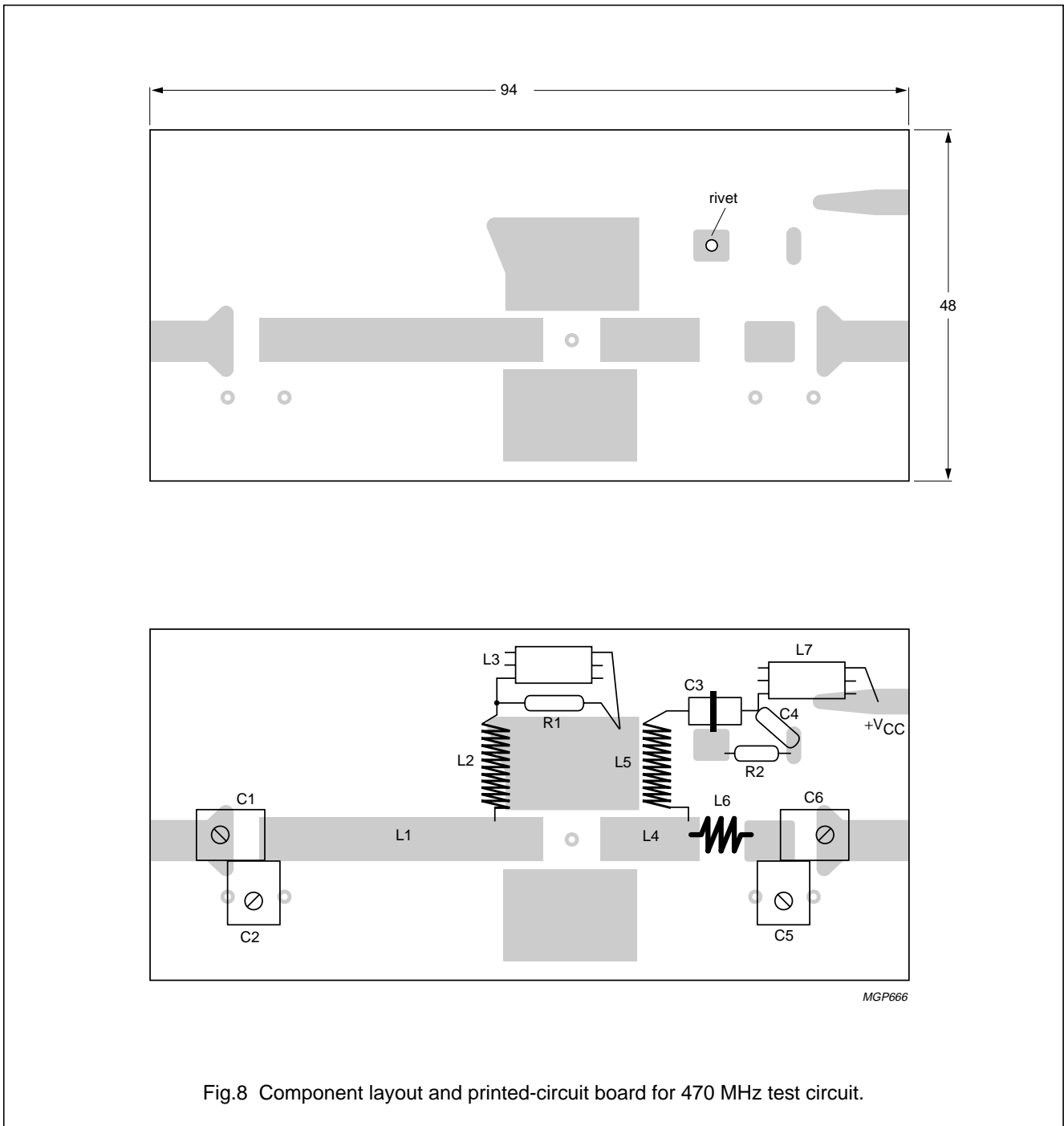

The circuit and the components are situated on one side of the PTFE fibre-glass board, the other side being fully metallized to serve as earth. Earth connections are made by means of hollow rivets, whilst under the emitter leads Cu straps are used for a direct contact between upper and lower sheets.

UHF power transistor

BLW90

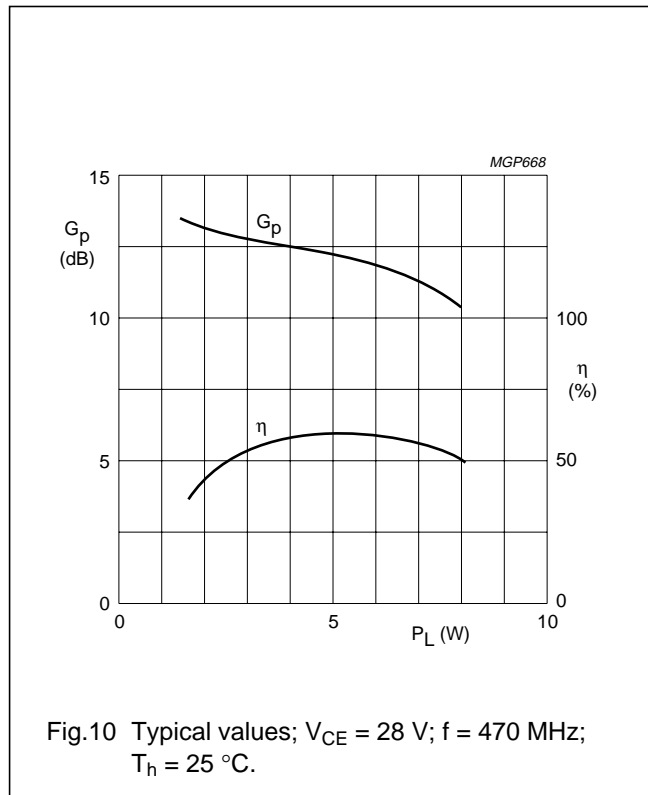
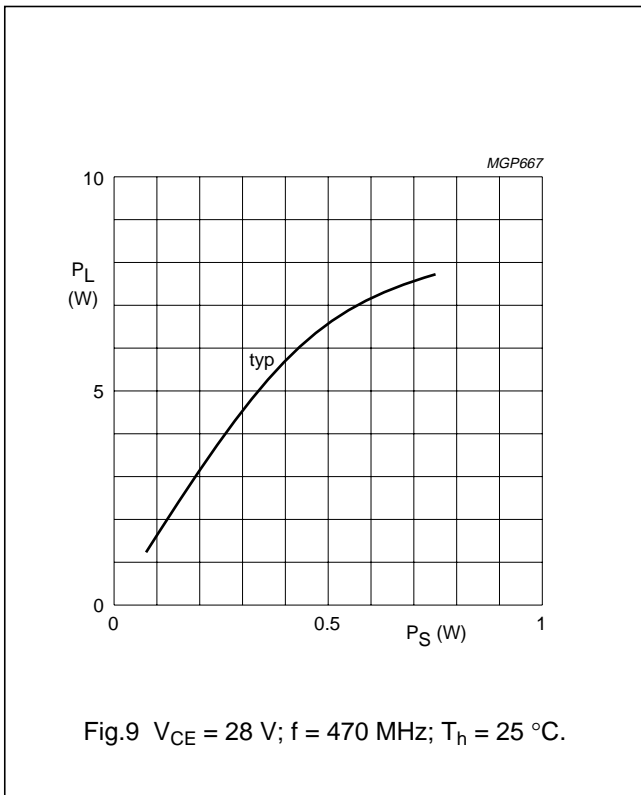

UHF power transistor

BLW90

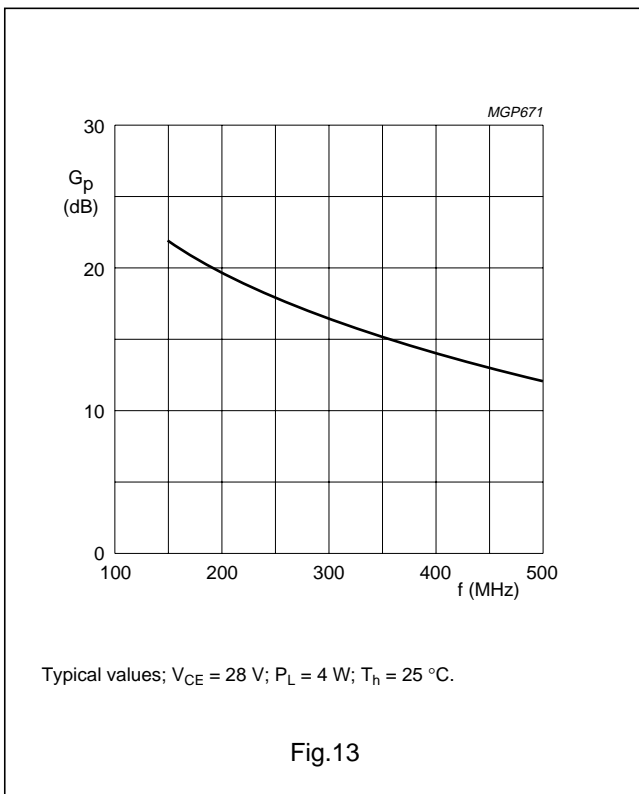
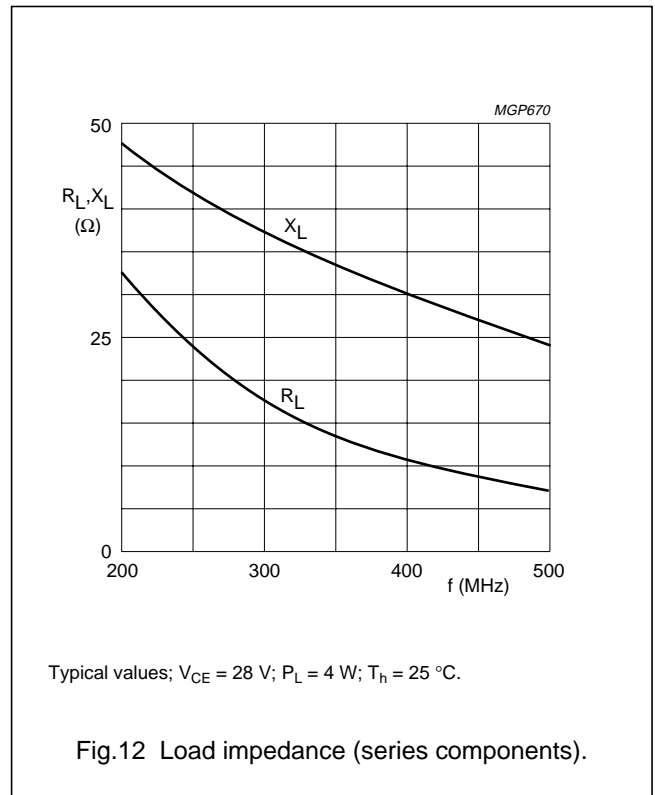
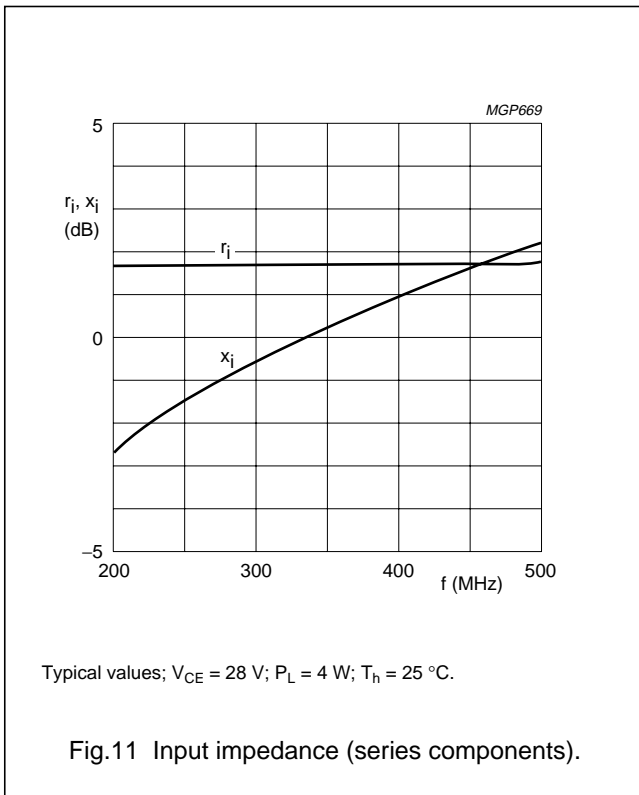

Ruggedness

The BLW90 is capable of withstanding full load mismatch (VSWR = 50 through all phases) up to 4 W under the following conditions:

$V_{CE} = 28\text{ V}$; $f = 470\text{ MHz}$; $T_h = 70\text{ }^\circ\text{C}$; $R_{th\text{ mb-h}} = 0,6\text{ K/W}$.

UHF power transistor

BLW90

PACKAGE OUTLINE

Studded ceramic package; 4 leads

SOT122A

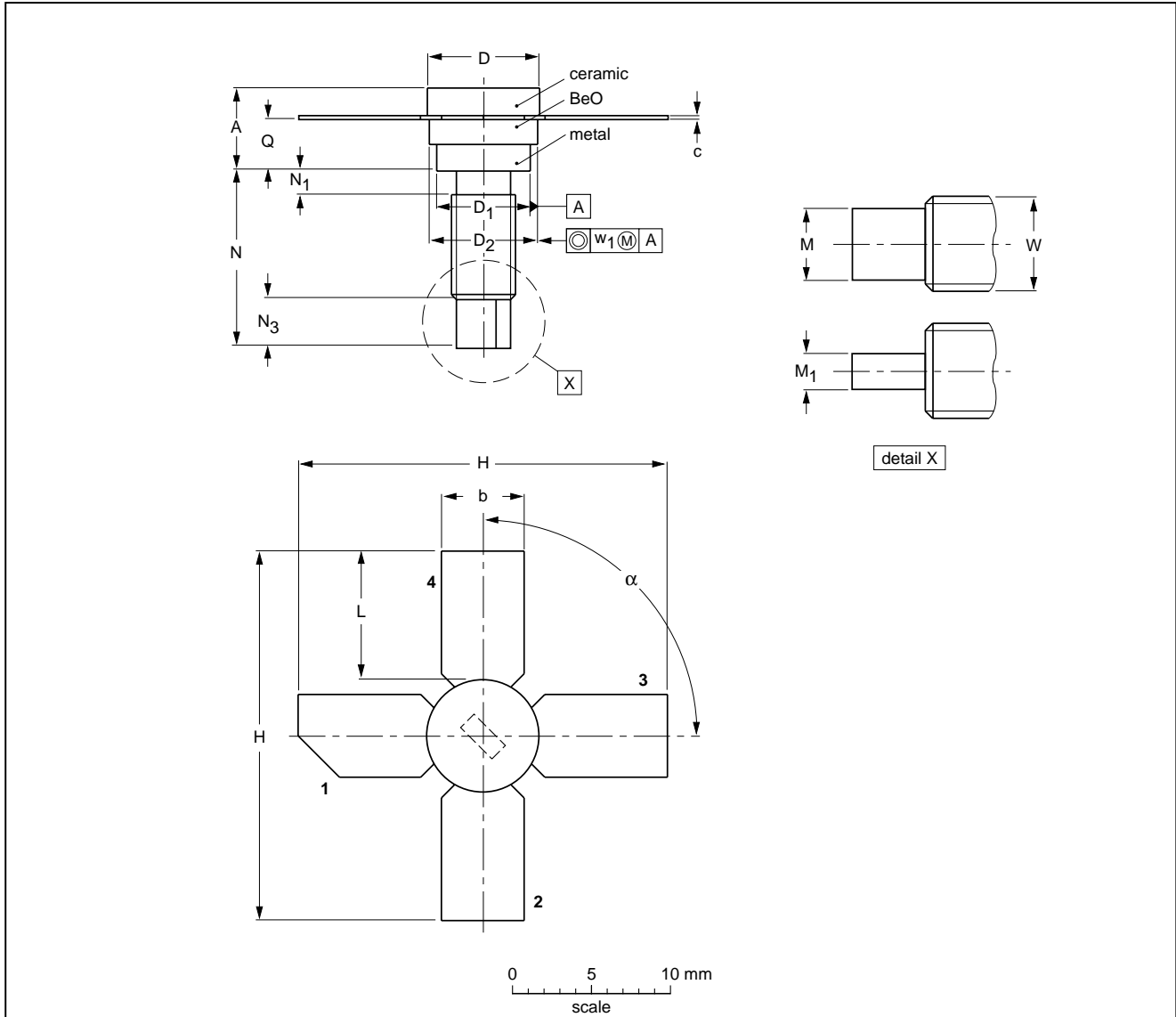

DIMENSIONS (millimetre dimensions are derived from the original inch dimensions)

UNIT	A	b	c	D	D ₁	D ₂	H	L	M ₁	M	N	N ₁ max.	N ₃	Q	W	w ₁	α
mm	5.97 4.74	5.85 5.58	0.18 0.14	7.50 7.23	6.48 6.22	7.24 6.93	27.56 25.78	9.91 9.14	3.18 2.66	1.66 1.39	11.82 11.04	1.02	3.86 2.92	3.38 2.74	8-32 UNC	0.381	90°

OUTLINE VERSION	REFERENCES				EUROPEAN PROJECTION	ISSUE DATE
	IEC	JEDEC	EIAJ			
SOT122A						97-04-18

UHF power transistor

BLW90

DEFINITIONS

Data Sheet Status	
Objective specification	This data sheet contains target or goal specifications for product development.
Preliminary specification	This data sheet contains preliminary data; supplementary data may be published later.
Product specification	This data sheet contains final product specifications.
Limiting values	
Limiting values given are in accordance with the Absolute Maximum Rating System (IEC 134). Stress above one or more of the limiting values may cause permanent damage to the device. These are stress ratings only and operation of the device at these or at any other conditions above those given in the Characteristics sections of the specification is not implied. Exposure to limiting values for extended periods may affect device reliability.	
Application information	
Where application information is given, it is advisory and does not form part of the specification.	

LIFE SUPPORT APPLICATIONS

These products are not designed for use in life support appliances, devices, or systems where malfunction of these products can reasonably be expected to result in personal injury. Philips customers using or selling these products for use in such applications do so at their own risk and agree to fully indemnify Philips for any damages resulting from such improper use or sale.