

DATA SHEET

BLX94C UHF power transistor

Product specification

1996 Feb 06

UHF power transistor

BLX94C

FEATURES

- Withstands full load mismatch
- Emitter ballasting resistors for an optimum temperature profile
- Gold metallization ensures excellent reliability.

APPLICATIONS

- Transmitting applications in the UHF range with a nominal supply voltage up to 28 V.

PINNING - SOT122A

PIN	SYMBOL	DESCRIPTION
1	c	collector
2	e	emitter
3	b	base
4	e	emitter

DESCRIPTION

NPN silicon planar epitaxial transistor primarily intended for class-A, B or C operation. The transistor is encapsulated in a 4-lead SOT122A stud envelope with a ceramic cap.

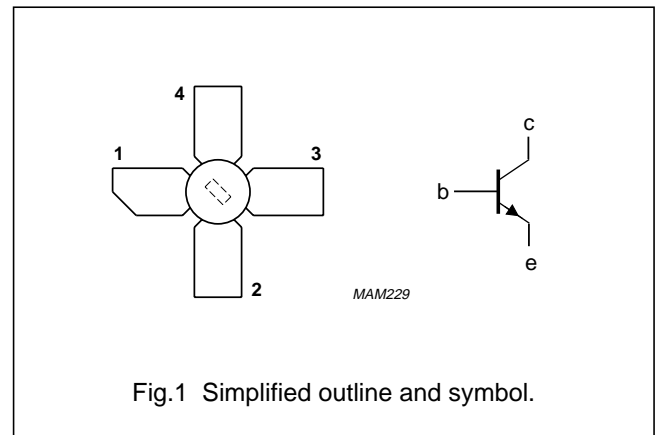

QUICK REFERENCE DATA

RF performance at $T_h = 25\text{ }^\circ\text{C}$ in a common emitter test circuit.

MODE OF OPERATION	f (MHz)	V_{CE} (V)	P_L (W)	G_p (dB)	η_c (%)
CW, class-B	470	28	25	>6.5	>55

WARNING
Product and environmental safety - toxic materials
<p>This product contains beryllium oxide. The product is entirely safe provided that the BeO disc is not damaged. All persons who handle, use or dispose of this product should be aware of its nature and of the necessary safety precautions. After use, dispose of as chemical or special waste according to the regulations applying at the location of the user. It must never be thrown out with the general or domestic waste.</p>

UHF power transistor

BLX94C

LIMITING VALUES

In accordance with the Absolute Maximum Rating System (IEC 134).

SYMBOL	PARAMETER	CONDITIONS	MIN.	MAX.	UNIT
V_{CESM}	collector-emitter voltage (peak value)	$V_{BE} = 0$	–	65	V
V_{CEO}	collector-emitter voltage	open base	–	30	V
V_{EBO}	emitter-base voltage	open collector	–	4	V
I_C	collector current (DC)		–	2.5	A
$I_{C(AV)}$	average collector current		–	2.5	A
I_{CM}	peak collector current	$f > 1 \text{ MHz}$	–	6	A
P_{tot}	total power dissipation	$\leq T_{mb} = 25 \text{ }^\circ\text{C}$	–	60	W
T_{stg}	storage temperature		–65	+150	$^\circ\text{C}$
T_j	operating junction temperature		–	200	$^\circ\text{C}$

THERMAL CHARACTERISTICS

SYMBOL	PARAMETER	CONDITIONS	VALUE	UNIT
$R_{th\ j-mb}$	thermal resistance from junction to mounting base (DC dissipation)	$P_{tot} = 20 \text{ W}; T_{mb} = 82 \text{ }^\circ\text{C}; T_h = 70 \text{ }^\circ\text{C}$	4	K/W
$R_{th\ j-mb}$	thermal resistance from junction to mounting base (RF dissipation)	$P_{tot} = 20 \text{ W}; T_{mb} = 82 \text{ }^\circ\text{C}; T_h = 70 \text{ }^\circ\text{C}$	2.7	K/W
$R_{th\ mb-h}$	thermal resistance from mounting base to heatsink	$P_{tot} = 20 \text{ W}; T_{mb} = 82 \text{ }^\circ\text{C}; T_h = 70 \text{ }^\circ\text{C}$	0.6	K/W

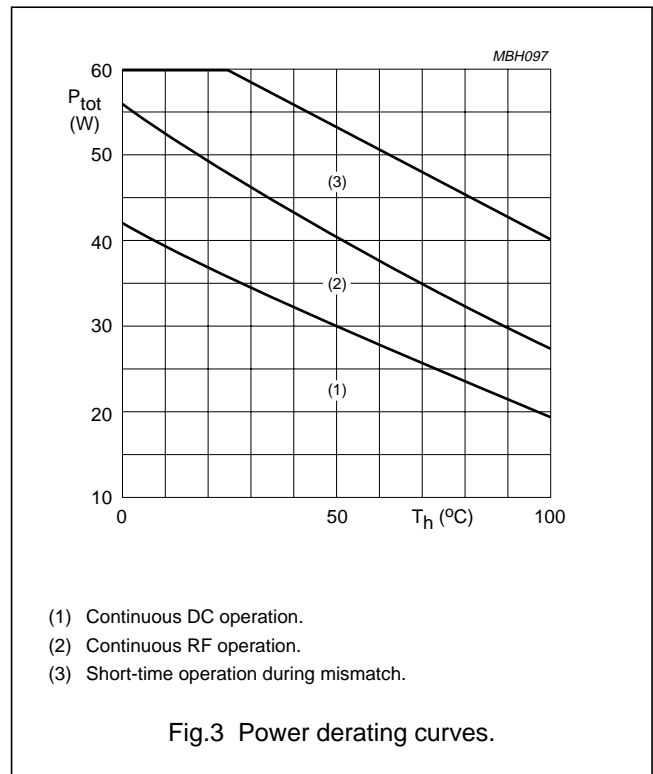
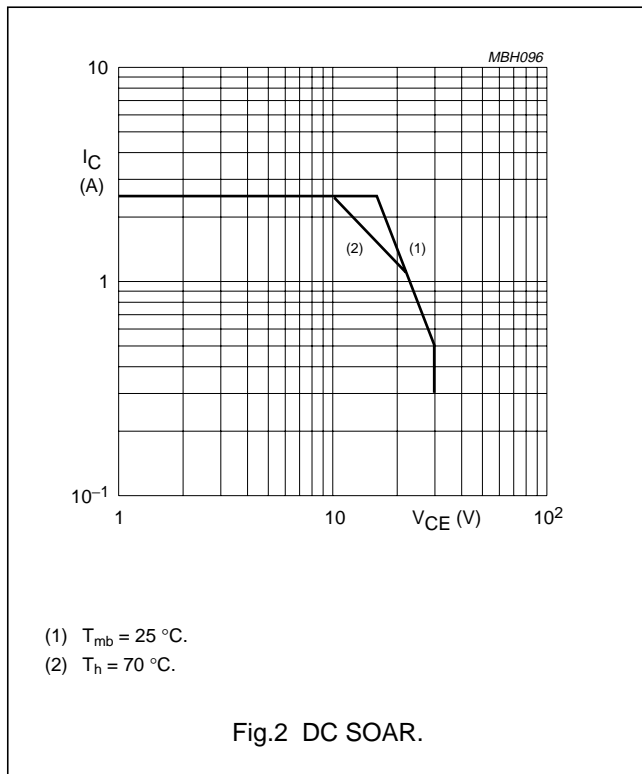

UHF power transistor

BLX94C

CHARACTERISTICS

$T_j = 25\text{ }^\circ\text{C}$ unless otherwise specified.

SYMBOL	PARAMETER	CONDITIONS	MIN.	TYP.	MAX.	UNIT
$V_{(BR)CES}$	collector-emitter breakdown voltage	$V_{BE} = 0$; $I_C = 25\text{ mA}$	65	–	–	V
$V_{(BR)CEO}$	collector-emitter breakdown voltage	open base; $I_C = 100\text{ mA}$	30	–	–	V
$V_{(BR)EBO}$	emitter-base breakdown voltage	open collector; $I_E = 10\text{ mA}$	4	–	–	V
V_{CEsat}	collector-emitter saturation voltage	$I_C = 4\text{ A}$; $I_B = 0.8\text{ A}$; note 1	–	1.5	–	V
I_{CES}	collector cut-off current	$V_{BE} = 0$; $V_{CE} = 30\text{ V}$	–	–	10	mA
E_{SBR}	second breakdown energy	open base; $L = 25\text{ mH}$; $f = 50\text{ Hz}$	3	–	–	mJ
		$R_{BE} = 10\ \Omega$; $L = 25\text{ mH}$; $f = 50\text{ Hz}$	3	–	–	mJ
h_{FE}	DC current gain	$V_{CE} = 5\text{ V}$; $I_C = 1.5\text{ A}$; note 1	15	50	–	
f_T	transition frequency	$V_{CB} = 28\text{ V}$; $I_E = -1.5\text{ A}$; $f = 500\text{ MHz}$; note 1	–	1.1	–	f_T
		$V_{CB} = 28\text{ V}$; $I_E = -4\text{ A}$; $f = 500\text{ MHz}$; note 1	–	0.75	–	f_T
C_c	collector capacitance	$V_{CB} = 28\text{ V}$; $I_E = i_e = 0$; $f = 1\text{ MHz}$	–	33	–	pF
C_{re}	feedback capacitance	$V_{CE} = 28\text{ V}$; $I_C = 20\text{ mA}$; $f = 1\text{ MHz}$;	–	18	–	pF
C_{c-s}	collector-stud capacitance		–	1.2	–	pF

Note

1. Measured under pulsed conditions: $t_p \leq 200\ \mu\text{s}$; $\delta \leq 0.02$.

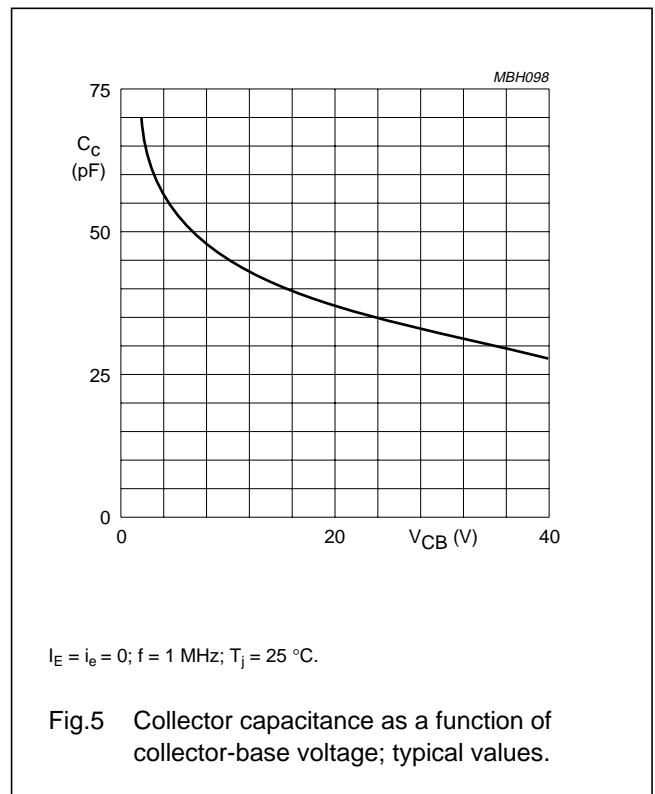
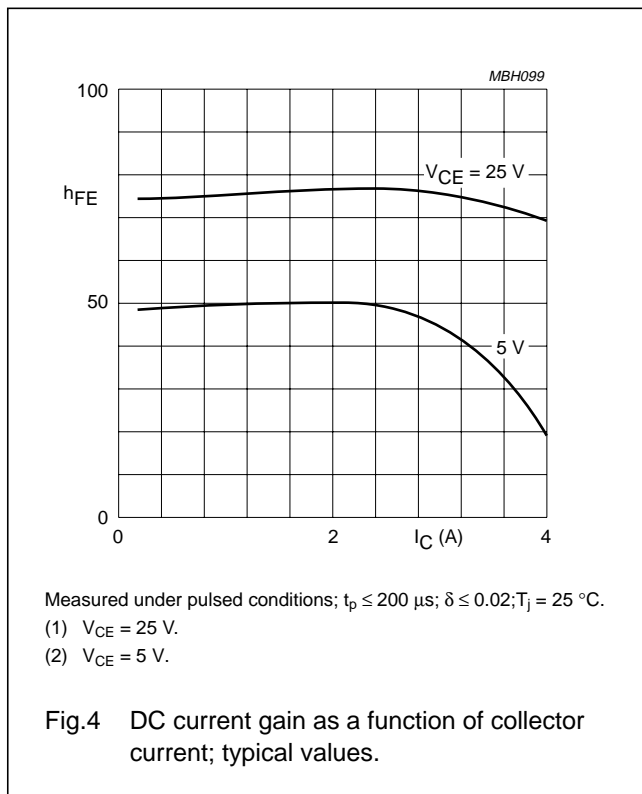

UHF power transistor

BLX94C

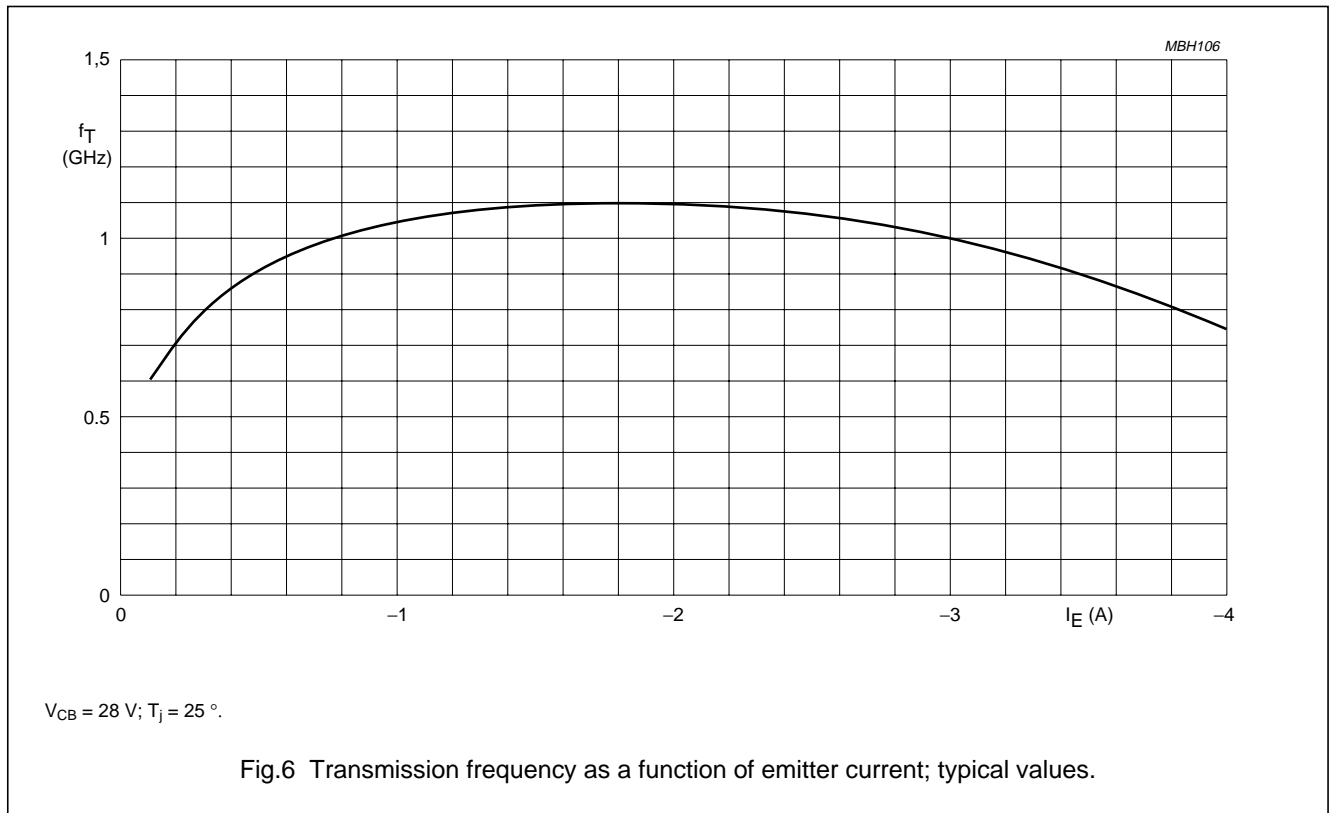

UHF power transistor

BLX94C

APPLICATION INFORMATION

RF performance at $T_h = 25\text{ }^\circ\text{C}$ in a common emitter, class-B test circuit.

MODE OF OPERATION	f (MHz)	V _{CE} (V)	P _L (W)	P _S (W)	G _p (dB)	I _c (A)	η _c (%)
CW, class-B	470	28	25	<5.6 typ. 4.7	>6.5 typ. 7.25	<1.62 typ. 1.54	>55 typ. 58

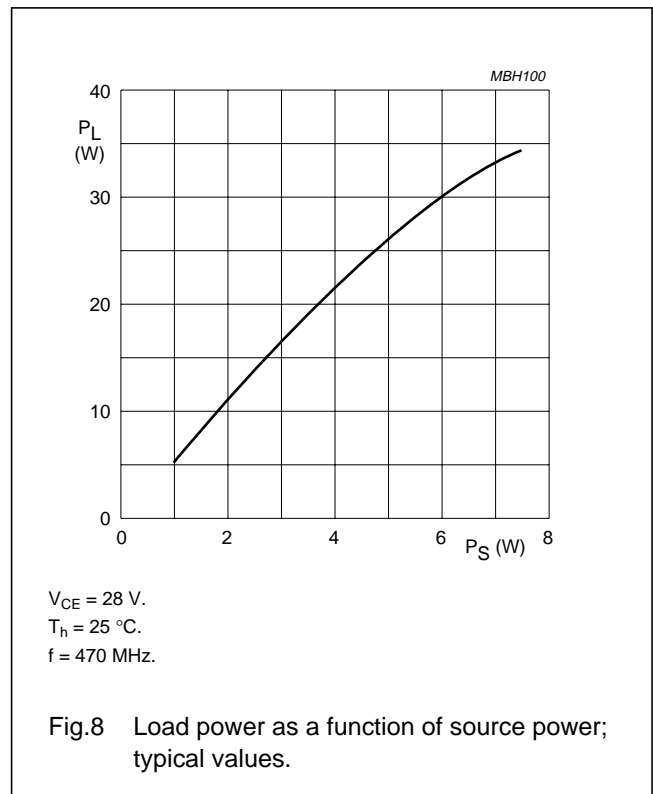
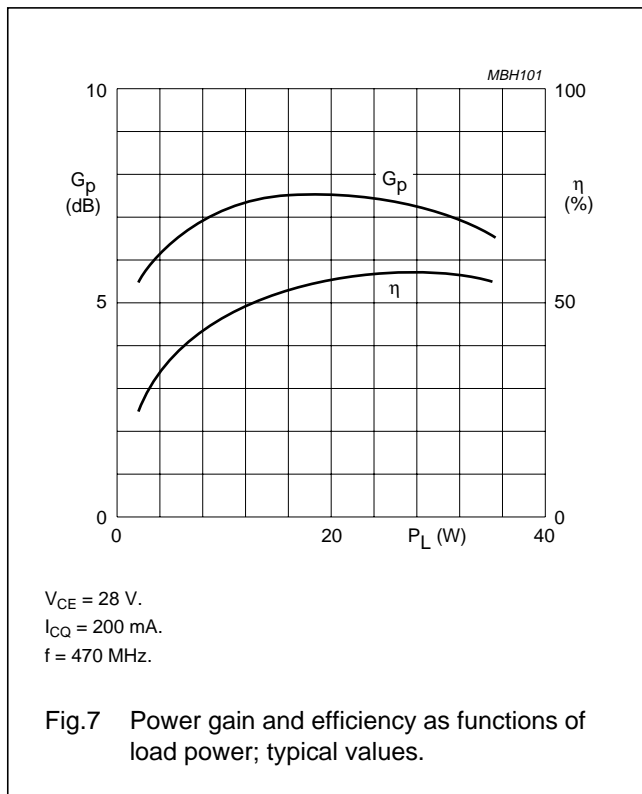

UHF power transistor

BLX94C

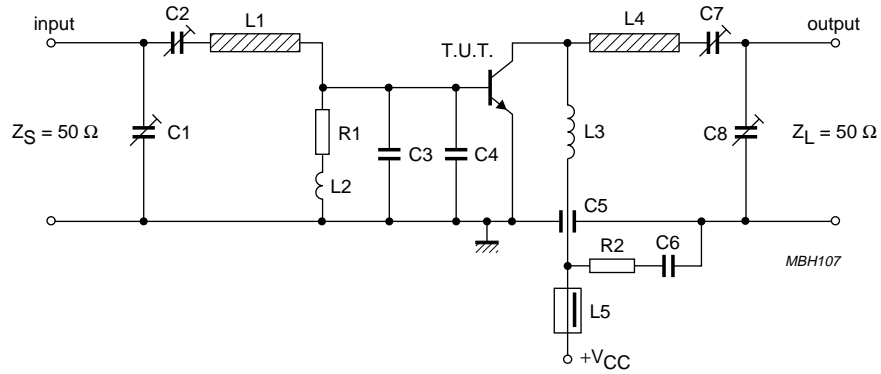

Fig.9 Class-B test circuit at f = 470 MHz.

List of components (see Figs 9 and 10)

COMPONENT	DESCRIPTION	VALUE	DIMENSIONS	CATALOGUE No.
C1, C2, C8	film dielectric trimmer capacitor	2 to 9 pF		2222 809 09002
C3, C4	chip capacitor	15 pF		
C5	feed through capacitor	100 pF		
C6	polyester capacitor	33 nF		
C6	chip capacitor	22 nF, 63 V		
C7	film dielectric trimmer capacitor	2 to 18 pF		2222 809 09003
L1	stripline; note 1		length 41.1 mm width 5 mm	
L2	13 turns enamelled 0.5 mm copper wire		int. diameter 4 mm close wound	
L3	2 turns 1 mm copper wire		int. diameter 4 mm winding pitch 1.5 mm leads 2 x 5 mm	
L4	stripline; note 1		length 52.7 mm width 5 mm	
L5	Ferroxcube choke coil	750 Ω; ± 20%		4312 020 36640
R1	carbon resistor	1 Ω		
R2	carbon resistor	10 Ω		

Note

1. The striplines are on double-clad PCB with PTFE fibre-glass dielectric ($\epsilon_r = 2.74$); thickness 1.45 mm.

UHF power transistor

BLX94C

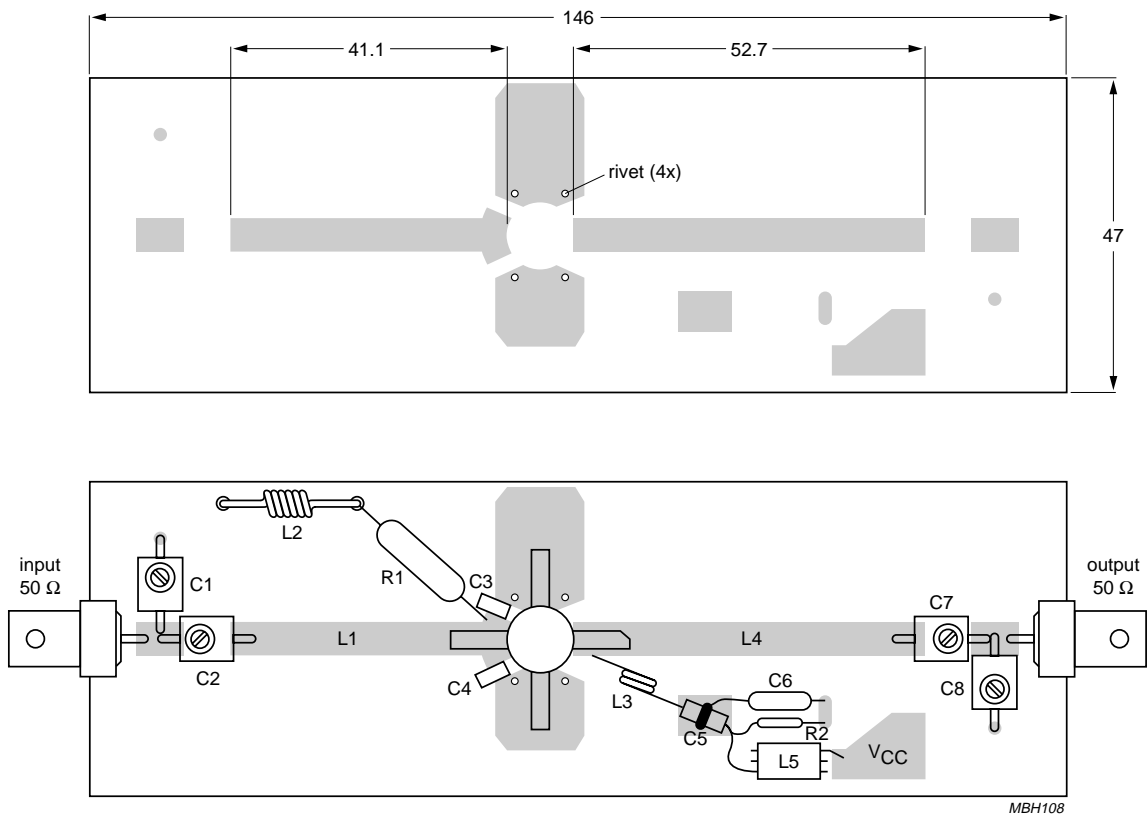

Dimensions in mm.

The components are located on one side of the copper-clad PTFE microfibre-glass board, the other side is unetched and serves as a ground plane. Earth connections from the component side to the ground plane are made by through metallization.

Fig.10 Component layout and printed-circuit board for 470 MHz class-B test circuit.

UHF power transistor

BLX94C

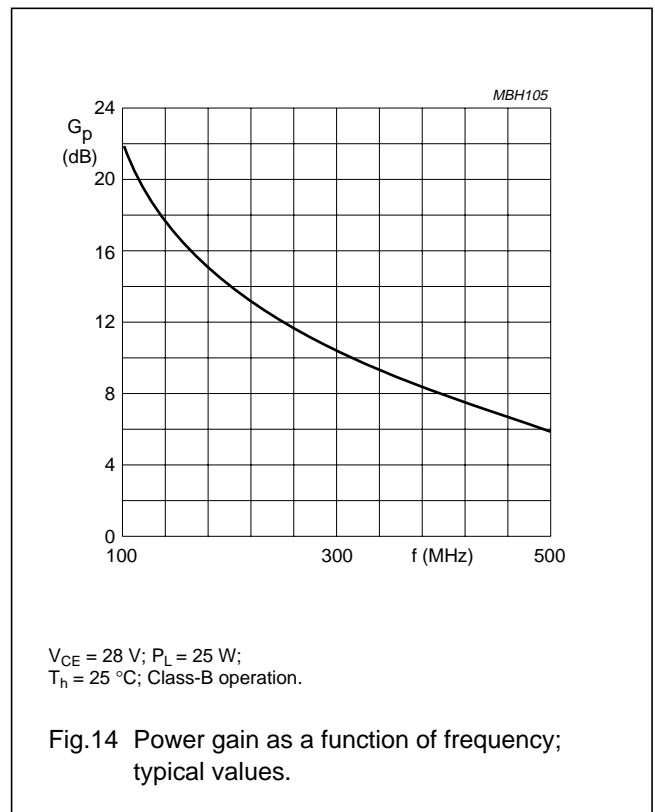
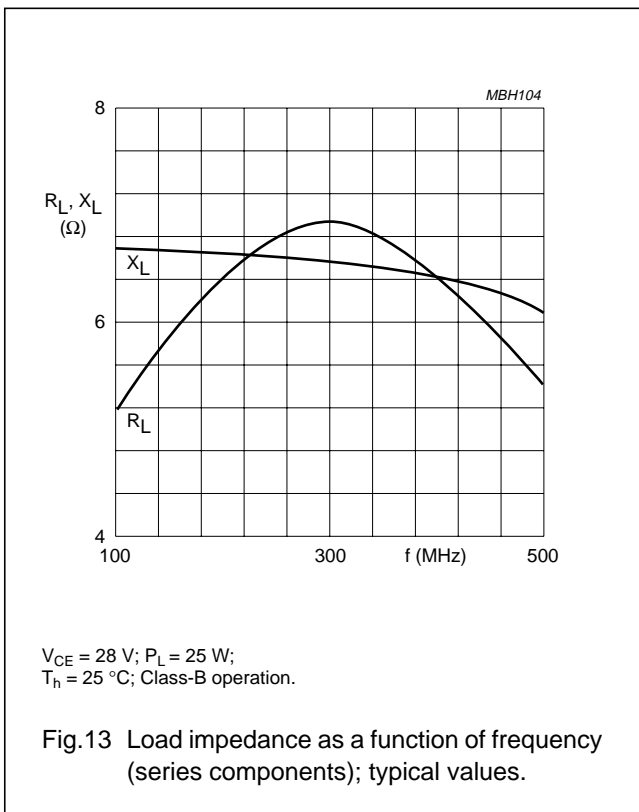
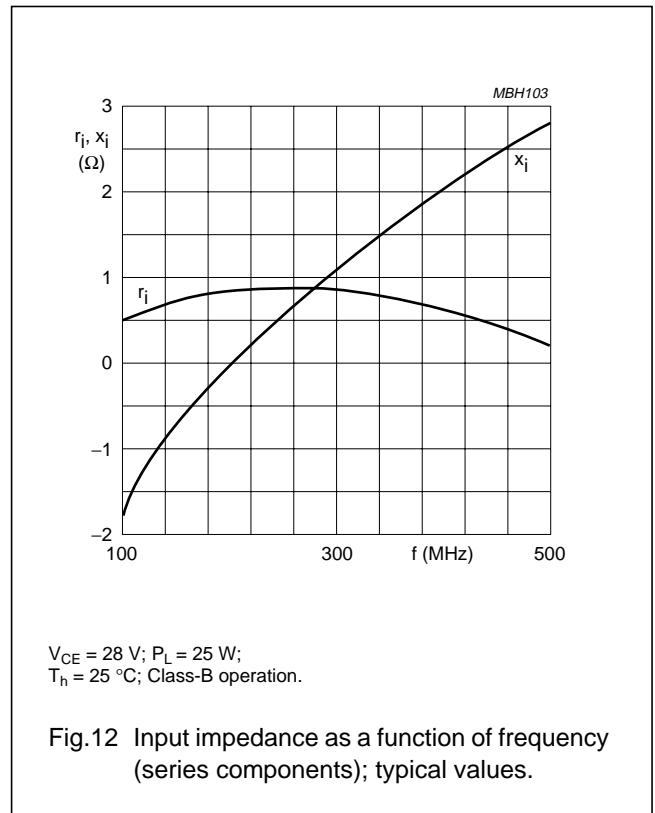
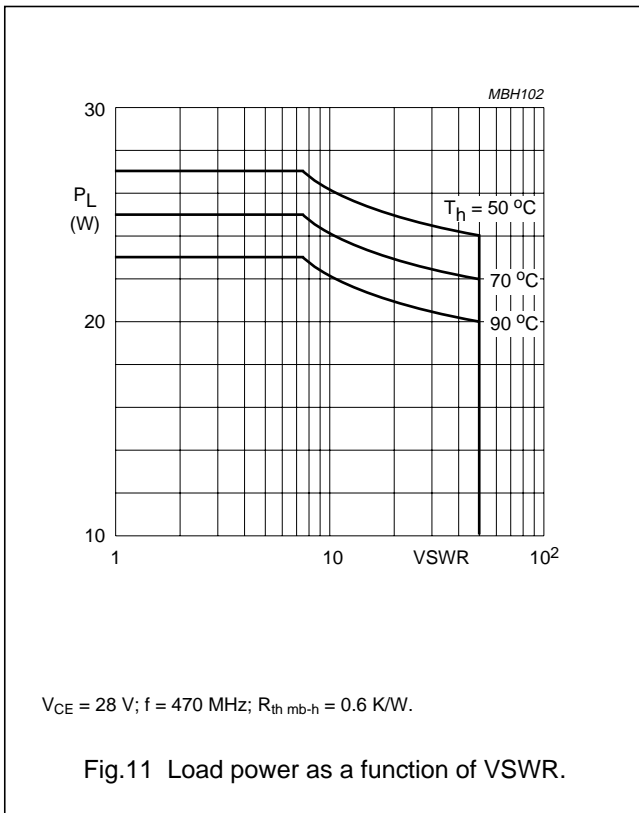

UHF power transistor

BLX94C

PACKAGE OUTLINE

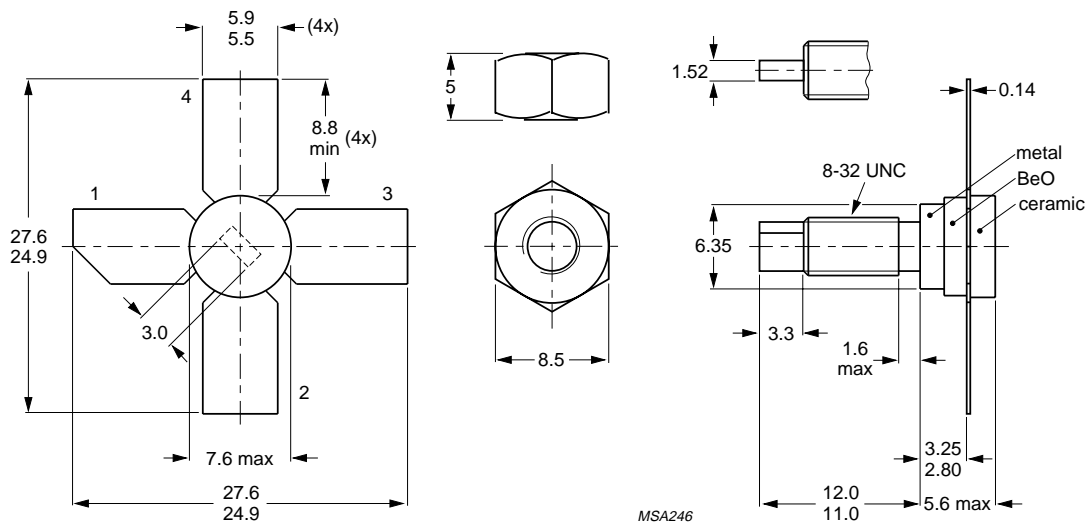

Dimensions in mm.
 Torque on nut: min. 0.75 Nm; max. 0.85 Nm.
 Mounting hole to have no burrs at either end.
 De-burring must leave surface flat; do not chamfer or countersink either end of hole.
 When locking is required an adhesive is preferred instead of a lock washer.

Fig.15 SOT122A.

UHF power transistor

BLX94C

DEFINITIONS

Data Sheet Status	
Objective specification	This data sheet contains target or goal specifications for product development.
Preliminary specification	This data sheet contains preliminary data; supplementary data may be published later.
Product specification	This data sheet contains final product specifications.
Limiting values	
Limiting values given are in accordance with the Absolute Maximum Rating System (IEC 134). Stress above one or more of the limiting values may cause permanent damage to the device. These are stress ratings only and operation of the device at these or at any other conditions above those given in the Characteristics sections of the specification is not implied. Exposure to limiting values for extended periods may affect device reliability.	
Application information	
Where application information is given, it is advisory and does not form part of the specification.	

LIFE SUPPORT APPLICATIONS

These products are not designed for use in life support appliances, devices, or systems where malfunction of these products can reasonably be expected to result in personal injury. Philips customers using or selling these products for use in such applications do so at their own risk and agree to fully indemnify Philips for any damages resulting from such improper use or sale.