

Type	BMS-1811
Rated Impedance(Ω)	$8 \pm 15\%$
Rated(Max.) Power(W)	0.1(0.1)
Resonant Frequency(Hz)	$800 \pm 25\%$
Rated Freq.Range(Hz)	$f_0 \sim 3500$
Sound Pressure Level(dB)	70 ± 3
Magnet(g)	0.6
Operating Temperature($^{\circ}\text{C}$)	$-10 \sim +40$

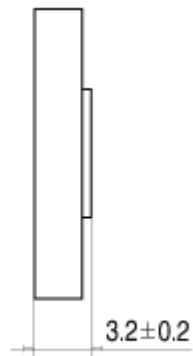

Unit:mm

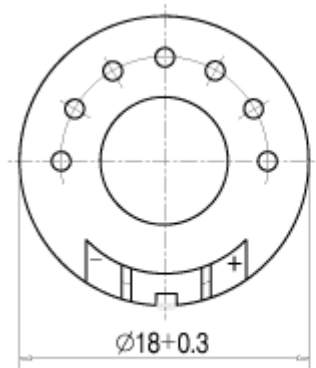