

Breakover diodes

BRS212 series

GENERAL DESCRIPTION

A range of bidirectional, breakover diodes in a two terminal, surface mounting, plastic envelope. These devices feature controlled breakover voltage and high holding current together with high peak current handling capability. Their intended application is protection of line based telecommunications equipment against voltage transients.

QUICK REFERENCE DATA

SYMBOL	PARAMETER	MIN.	TYP.	MAX.	UNIT
$V_{(BO)}$	Breakover voltage				
	BRS212-140	-	140	-	V
	BRS212-160	-	160	-	V
	BRS212-180	-	180	-	V
	BRS212-200	-	200	-	V
	BRS212-220	-	220	-	V
	BRS212-240	-	240	-	V
	BRS212-260	-	260	-	V
I_H	Holding current	150	-	-	mA
	I_{PP} Non-repetitive peak pulse current (CCITT K17)	-	-	40	A

OUTLINE - SOD106

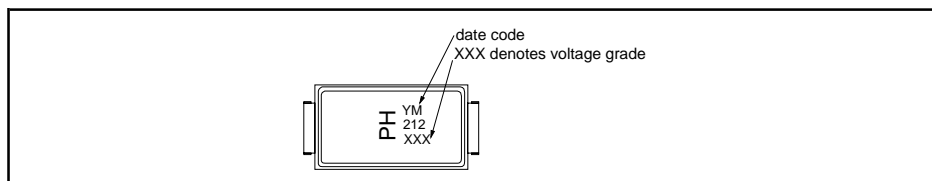

SYMBOL

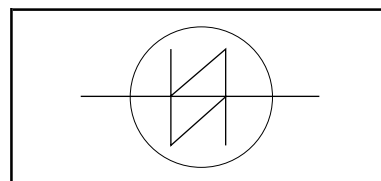

LIMITING VALUES

Limiting values in accordance with the Absolute Maximum System (IEC 134).

SYMBOL	PARAMETER	CONDITIONS	MIN.	MAX.	UNIT
V_D	Continuous voltage	BRS212-140	-	105	V
		BRS212-160	-	120	V
		BRS212-180	-	135	V
		BRS212-200	-	150	V
		BRS212-220	-	165	V
		BRS212-240	-	180	V
		BRS212-260	-	195	V
		BRS212-280	-	210	V
I_{PP}	Non-repetitive peak pulse current	5/310 μ s impulse equivalent to 10/700 μ s, 1.6 kV voltage impulse (CCITT K17)	-	40	A
I_{TSM}	Non repetitive surge peak on-state current	half sine wave; t = 10 ms; $T_j = 70^\circ\text{C}$ prior to surge	-	15	A
I^2t	I^2t for fusing	$t_p = 10$ ms	-	1.1	A ² s
dl_T/dt	Rate of rise of on-state current after $V_{(BO)}$ turn-on	$t_p = 10$ μ s	-	50	A/ μ s
P_{tot}	Continuous dissipation on infinite heatsink	$T_{sp} = 50^\circ\text{C}$	-	4	W
P_{TM}	Peak dissipation	$t_p = 1$ ms; $T_a = 25^\circ\text{C}$	-	50	W
T_{stg}	Storage temperature		- 40	150	$^\circ\text{C}$
T_j	Operating junction temperature		-	150	$^\circ\text{C}$
T_L	Maximum terminal temperature for soldering	soldering time = 10 s	-	260	$^\circ\text{C}$

Breakover diodes

BRS212 series

THERMAL RESISTANCES

SYMBOL	PARAMETER	CONDITIONS	MIN.	TYP.	MAX.	UNIT
$R_{th\ j-sp}$	Thermal resistance junction to solder point		-	-	25	K/W
$R_{th\ j-a}$	Thermal resistance junction to ambient	pcb mounted; minimum footprint	-	100	-	K/W
$Z_{th\ j-a}$	Thermal impedance junction to ambient	$t_p = 1\ ms$	-	2.6	-	K/W

ELECTRICAL CHARACTERISTICS

$T_j = 25\ ^\circ C$ unless otherwise stated

TYPE	PARAMETER								
	Marking	Avalanche voltage		Breakover voltage		Off-state current		Critical rate of rise of off-state voltage	
Conditions		$I_{BR} = 10\ mA$		$I_D \leq I_S$ $t_p = 100\ \mu s$		$T_j = 70\ ^\circ C$; $RH \leq 65\%$		$T_j = 70\ ^\circ C$	
Symbol		V_{BR}		V_{BO}		$I_D @ V_D$		$dV_D/dt @ V_{DM}$	
Limits		min	typ	typ	max	max		max	
Units		V	V	V	V	μA	V	V/ μs	V
BRS212-140	212-140	123	140	140	157	10	105	2000	105
BRS212-160	212-160	140	160	160	180	10	120	2000	120
BRS212-180	212-180	158	180	180	202	10	135	2000	135
BRS212-200	212-200	176	200	200	224	10	150	2000	150
BRS212-220	212-220	193	220	220	247	10	165	2000	165
BRS212-240	212-240	211	240	240	269	10	180	2000	180
BRS212-260	212-260	228	260	260	292	10	195	2000	195
BRS212-280	212-280	246	280	280	314	10	210	2000	210

SYMBOL	PARAMETER	CONDITIONS	MIN.	TYP.	MAX.	UNIT
V_T	On-state voltage	$I_{TM} = 2\ A$; $t_p = 200\ \mu s$	-	-	2.5	V
I_H	Holding current ¹	$T_j = 25\ ^\circ C$	150	-	-	mA
I_S	Switching current ²	$T_j = 70\ ^\circ C$	100	-	-	mA
$S_{(BR)}$	Temperature coefficient of avalanche voltage	$t_p = 100\ \mu s$	10	200	1000	mA
C_j	Junction capacitance	$V_D = 0\ V$, $f = 1\ kHz$ to $1\ MHz$	-	+0.1	-	%/K
			-	-	100	pF

1 The minimum current at which the diode will remain in the on-state

2 The avalanche current required to switch the diode to the on-state.

Breakover diodes

BRS212 series

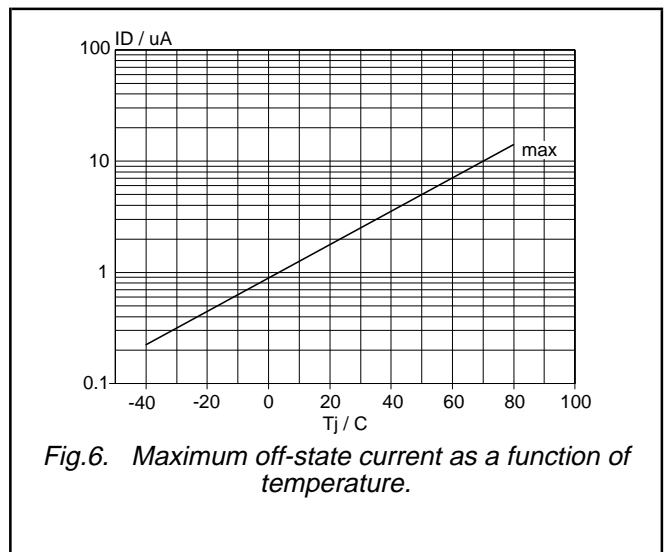
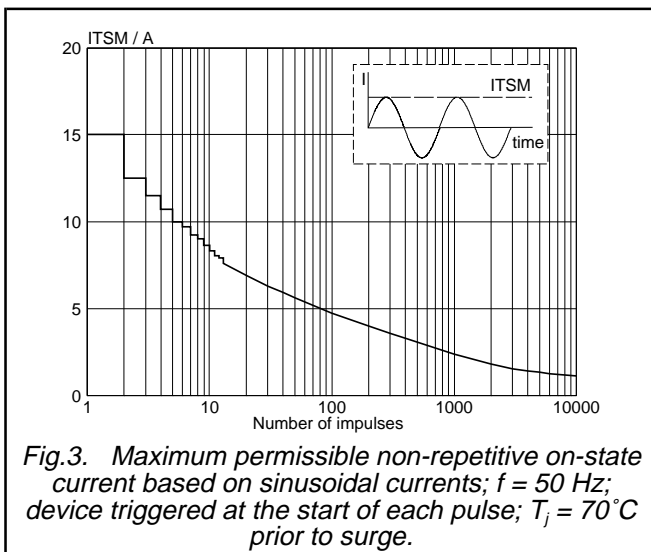
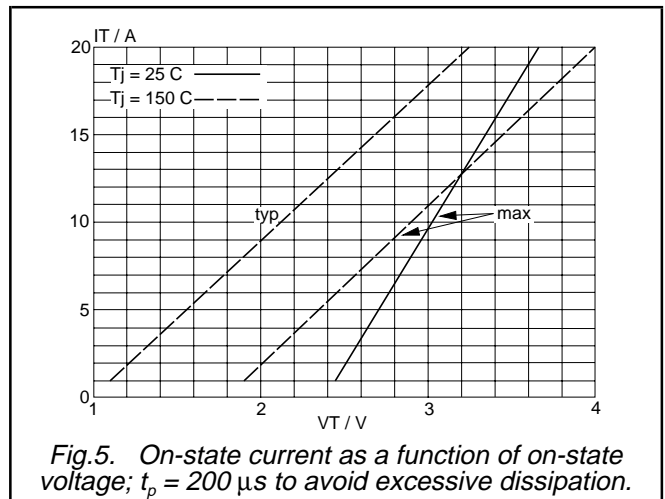
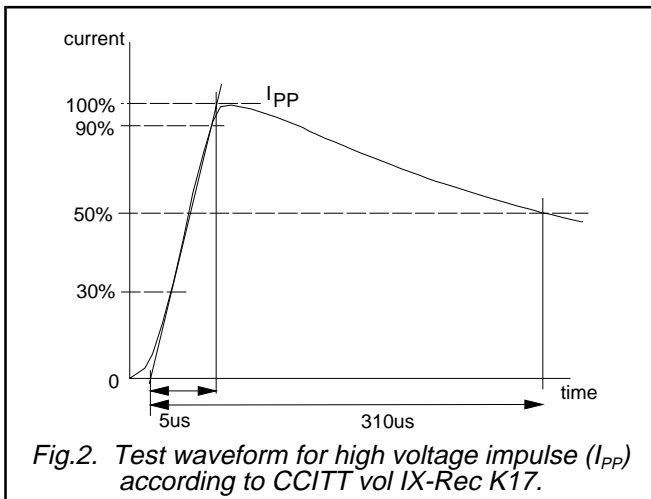
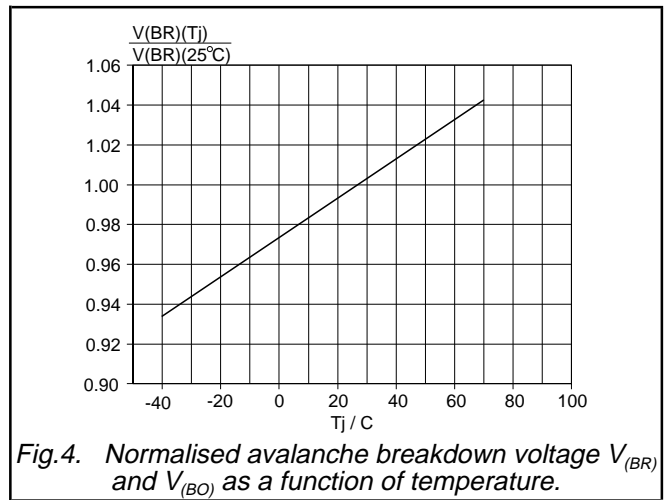
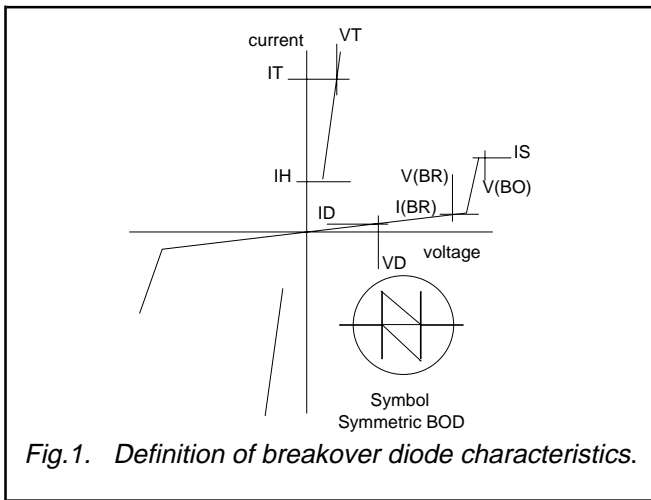

Breakover diodes

BRS212 series

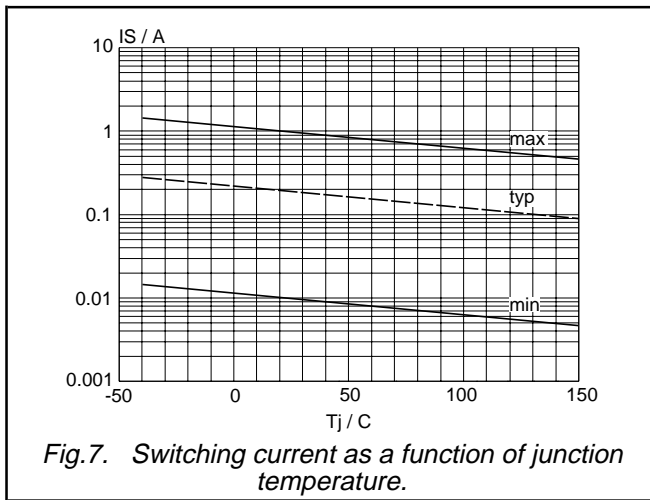

Fig.7. Switching current as a function of junction temperature.

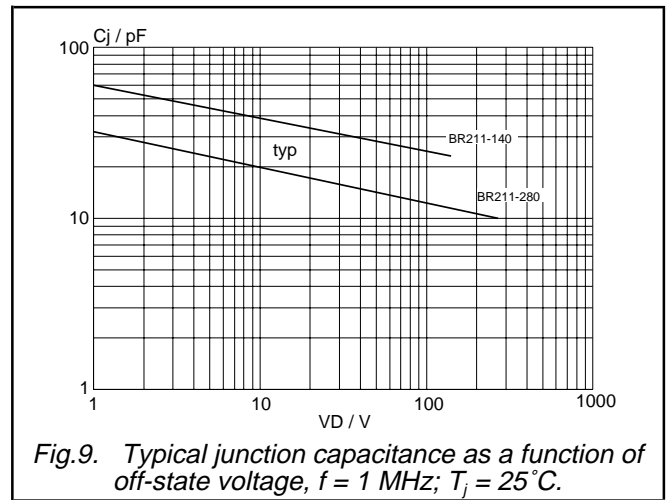

Fig.9. Typical junction capacitance as a function of off-state voltage, $f = 1$ MHz; $T_j = 25^\circ\text{C}$.

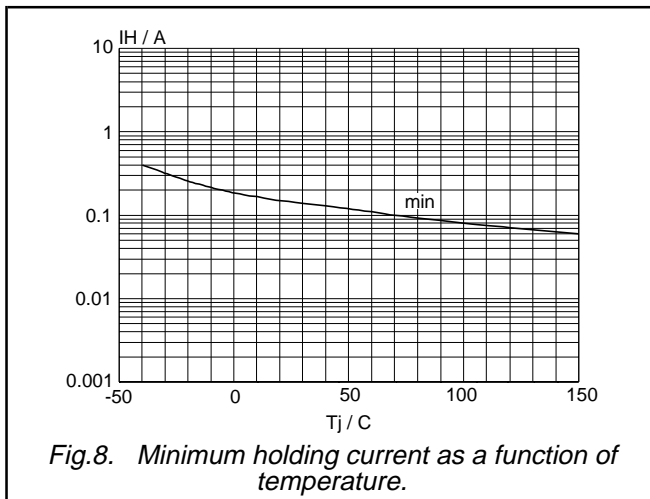

Fig.8. Minimum holding current as a function of temperature.

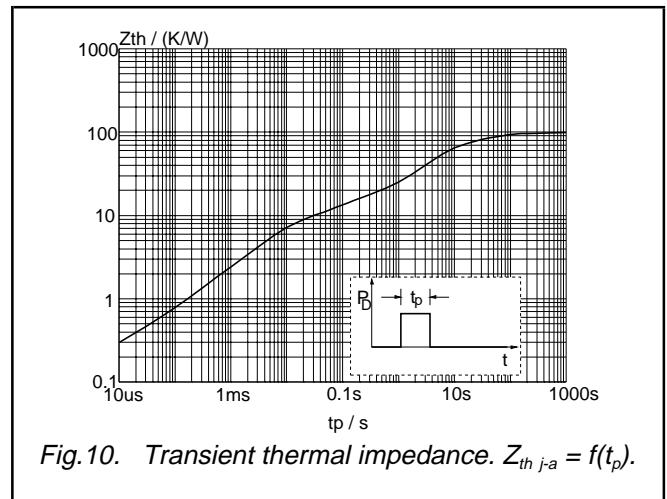
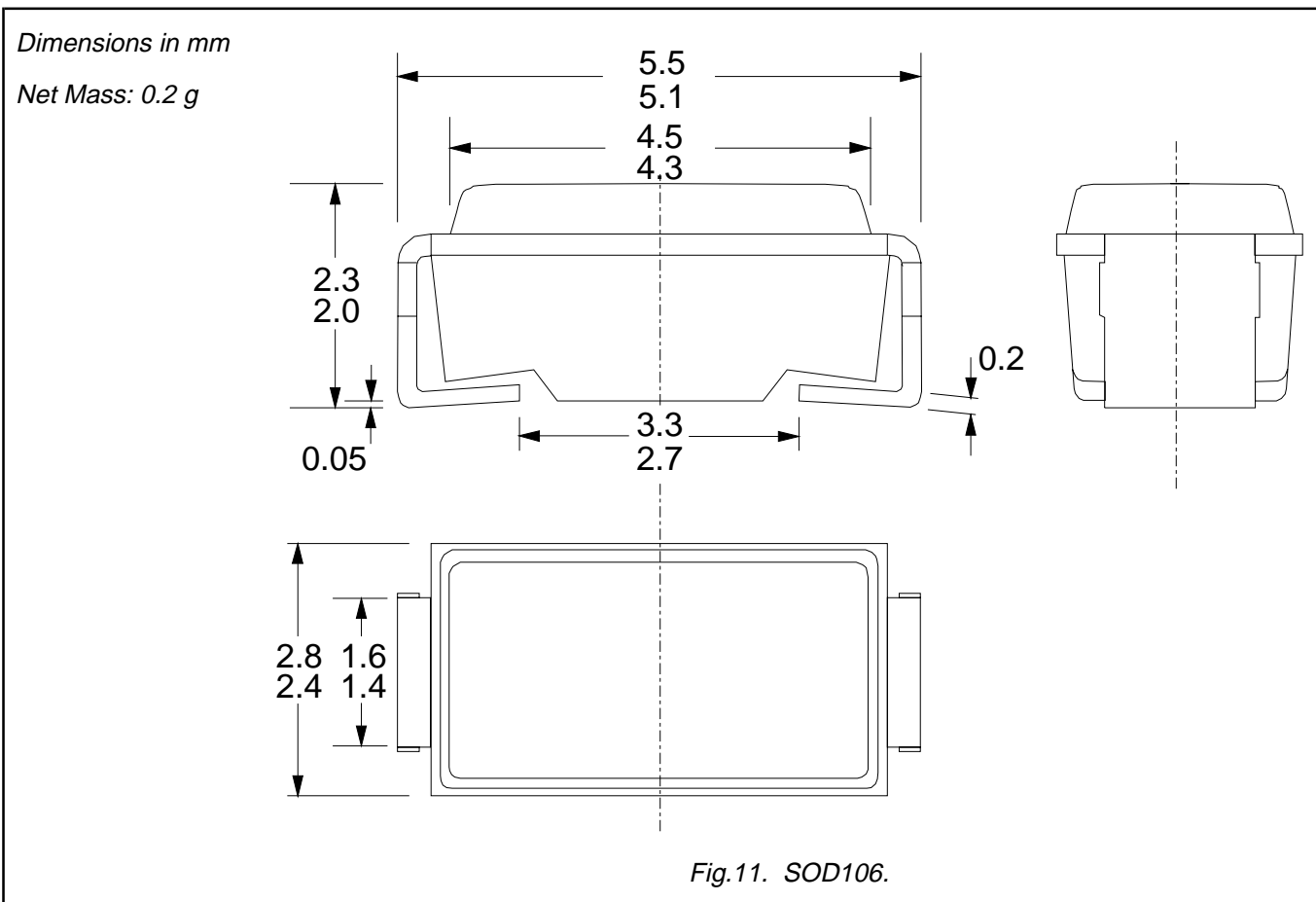

Fig.10. Transient thermal impedance. $Z_{th\ j-a} = f(t_p)$.

MECHANICAL DATA



Notes

1. For mounting and soldering instructions refer to publication SC18 "SMD Footprint Design and Soldering Guidelines". Order code:9397 750 00505.

Breakover diodes

BRS212 series

DEFINITIONS

Data sheet status	
Objective specification	This data sheet contains target or goal specifications for product development.
Preliminary specification	This data sheet contains preliminary data; supplementary data may be published later.
Product specification	This data sheet contains final product specifications.
Limiting values	
Limiting values are given in accordance with the Absolute Maximum Rating System (IEC 134). Stress above one or more of the limiting values may cause permanent damage to the device. These are stress ratings only and operation of the device at these or at any other conditions above those given in the Characteristics sections of this specification is not implied. Exposure to limiting values for extended periods may affect device reliability.	
Application information	
Where application information is given, it is advisory and does not form part of the specification.	
© Philips Electronics N.V. 1997	
All rights are reserved. Reproduction in whole or in part is prohibited without the prior written consent of the copyright owner.	
The information presented in this document does not form part of any quotation or contract, it is believed to be accurate and reliable and may be changed without notice. No liability will be accepted by the publisher for any consequence of its use. Publication thereof does not convey nor imply any license under patent or other industrial or intellectual property rights.	

LIFE SUPPORT APPLICATIONS

These products are not designed for use in life support appliances, devices or systems where malfunction of these products can be reasonably expected to result in personal injury. Philips customers using or selling these products for use in such applications do so at their own risk and agree to fully indemnify Philips for any damages resulting from such improper use or sale.