

Optocoupler, Phototriac Output, Zero Crossing

Features

- High Input Sensitivity $I_{FT} = 1.0 \text{ mA}$
- $I_{TRMS} = 300 \text{ mA}$
- High Static dv/dt 10,000 $V/\mu s$
- Electrically Insulated between Input and Output circuit
- Microcomputer compatible
- Trigger Current
 - ($I_{FT} < 1.2 \text{ mA}$) BRT22F, BRT23F,
 - ($I_{FT} < 2 \text{ mA}$) BRT21H, BRT22H, BRT23H
 - ($I_{FT} < 3 \text{ mA}$) BRT21M, BRT22M, BRT23M
- Available Surface Mount and on on tape and reel
- Zero Voltage Crossing detector
- UL File E52744 System Code "J"
- Lead-free component
- Component in accordance to RoHS 2002/95/EC and WEEE 2002/96/EC

Applications

- Industrial controls
- Office equipment
- Consumer appliances

Description

The BRT21, BRT22, BRT23 product family consists of AC switch optocouplers with zero voltage detectors with two electrically insulated lateral power ICs which integrate a thyristor system, a photo detector and noise suppression at the output and an IR GaAs diode input

High input sensitivity is achieved by using an emitter follower phototransistor and an SCR predriver resulting in an LED trigger current of less than 2 mA or 3 mA (DC). Inverse parallel SCRs provide commutating dv/dt greater than 10 $kV/\mu s$

The zero cross line voltage detection circuit consists of two MOSFETS and a photodiode.

The BRT21/ 22/ 23 product family isolates low-voltage logic from 120, 230 and 380 VAC lines to control resistive, inductive or capacitive loads including motors, solenoids, high current thyristers or TRIAC and relays.

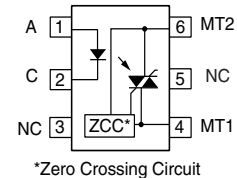
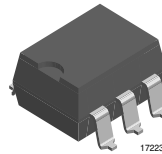

Order Information

Part	Remarks
BRT21H	$V_{DRM} \leq 400 \text{ V}$, DIP-6, 2.0 mA I_{FT}
BRT21M	$V_{DRM} \leq 400 \text{ V}$, DIP-6, 3.0 mA I_{FT}
BRT22F	$V_{DRM} \leq 600 \text{ V}$, DIP-6, 1.2 mA I_{FT}
BRT22H	$V_{DRM} \leq 600 \text{ V}$, DIP-6, 2.0 mA I_{FT}
BRT22M	$V_{DRM} \leq 600 \text{ V}$, DIP-6, 3.0 mA I_{FT}
BRT23F	$V_{DRM} \leq 800 \text{ V}$, DIP-6, 1.2 mA I_{FT}
BRT23H	$V_{DRM} \leq 800 \text{ V}$, DIP-6, 2.0 mA I_{FT}
BRT23M	$V_{DRM} \leq 800 \text{ V}$, DIP-6, 3.0 mA I_{FT}
BRT21H-X006	$V_{DRM} \leq 400 \text{ V}$, DIP-6 400 mil (option 6), 2.0 mA I_{FT}
BRT21H-X007	$V_{DRM} \leq 400 \text{ V}$, SMD-6 (option 7), 2.0 mA I_{FT}
BRT21M-X006	$V_{DRM} \leq 400 \text{ V}$, DIP-6 400 mil (option 6), 3.0 mA I_{FT}
BRT22F-X006	$V_{DRM} \leq 600 \text{ V}$, SMD-6 (option 7), 1.2 mA I_{FT}
BRT22F-X0067	$V_{DRM} \leq 600 \text{ V}$, SMD-6 (option 7), 1.2 mA I_{FT}
BRT22H-X007	$V_{DRM} \leq 600 \text{ V}$, SMD-6 (option 7), 2.0 mA I_{FT}
BRT22M-X006	$V_{DRM} \leq 600 \text{ V}$, DIP-6 400 mil (option 6), 3.0 mA I_{FT}
BRT23F-X006	$V_{DRM} \leq 800 \text{ V}$, DIP-6 400 mil (option 6), 1.2 mA I_{FT}
BRT23F-X007	$V_{DRM} \leq 800 \text{ V}$, DIP-6 400 mil (option 6), 1.2 mA I_{FT}
BRT23H-X006	$V_{DRM} \leq 800 \text{ V}$, DIP-6 400 mil (option 6), 2.0 mA I_{FT}
BRT23H-X007	$V_{DRM} \leq 800 \text{ V}$, SMD-6 (option 7), 2.0 mA I_{FT}
BRT23M-X006	$V_{DRM} \leq 800 \text{ V}$, DIP-6 400 mil (option 6), 3.0 mA I_{FT}
BRT23M-X007	$V_{DRM} \leq 800 \text{ V}$, SMD-6 (option 7), 3.0 mA I_{FT}

For additional information on the available options refer to Option Information.

Absolute Maximum Ratings

$T_{amb} = 25\text{ }^{\circ}\text{C}$, unless otherwise specified

Stresses in excess of the absolute Maximum Ratings can cause permanent damage to the device. Functional operation of the device is not implied at these or any other conditions in excess of those given in the operational sections of this document. Exposure to absolute Maximum Rating for extended periods of the time can adversely affect reliability.

Input

Parameter	Test condition	Symbol	Value	Unit
Reverse voltage	$I_R = 10\text{ }\mu\text{A}$	V_R	6.0	V
Forward current		I_F	60	mA
Surge current		I_{FSM}	2.5	A
Power dissipation		P_{diss}	100	mW
Derate from 25 °C			1.33	mW/°C

Output

Parameter	Test condition	Part	Symbol	Value	Unit
Peak off-state voltage	$I_{D(RMS)} = 70\text{ }\mu\text{A}$	BRT21	V_{DM}	400	V
		BRT22	V_{DM}	600	V
		BRT23	V_{DM}	800	V
RMS on-state current			I_{TM}	300	mA
Single cycle surge current				3.0	A
Power dissipation			P_{diss}	600	mW
Derate from 25 °C				6.6	mW/°C

Coupler

Parameter	Test condition	Symbol	Value	Unit
Isolation test voltage (between emitter and detector, climate per DIN 500414, part 2, Nov. 74)	$t = 1.0\text{ min.}$	V_{ISO}	5300	V_{RMS}
Pollution degree (DIN VDE 0109)			2	
Creepage			≥ 7.0	mm
Clearance			≥ 7.0	mm
Comparative tracking index per DIN IEC 112/VDE 0303 part 1, group IIIa per DIN VDE 6110			≥ 175	
Isolation resistance	$V_{IO} = 500\text{ V}, T_{amb} = 25\text{ }^{\circ}\text{C}$	R_{IO}	$\geq 10^{12}$	Ω
	$V_{IO} = 500\text{ V}, T_{amb} = 100\text{ }^{\circ}\text{C}$	R_{IO}	$\geq 10^{11}$	Ω
Storage temperature range		T_{stg}	- 55 to + 150	°C
Ambient temperature range		T_{amb}	- 55 to + 100	°C
Soldering temperature	max. $\leq 10\text{ sec.}$ dip soldering $\geq 0.5\text{ mm}$ from case bottom	T_{sld}	260	°C



Electrical Characteristics

$T_{amb} = 25\text{ }^{\circ}\text{C}$, unless otherwise specified

Minimum and maximum values are testing requirements. Typical values are characteristics of the device and are the result of engineering evaluation. Typical values are for information only and are not part of the testing requirements.

Input

Parameter	Test condition	Symbol	Min	Typ.	Max	Unit
Forward voltage	$I_F = 10\text{ mA}$	V_F		1.16	1.35	V
Reverse current	$V_R = 6.0\text{ V}$	I_R		0.1	10	μA
Capacitance	$V_F = 0\text{ V}$, $f = 1.0\text{ MHz}$	C_O		25		pF
Thermal resistance, junction to ambient		R_{thja}		750		K/W

Output

Parameter	Test condition	Symbol	Min	Typ.	Max	Unit
Off-state voltage	$I_{D(RMS)} = 70\text{ }\mu\text{A}$	$V_{D(RMS)}$	424	460		V
Repetitive peak off-state voltage	$I_{DRM} = 100\text{ }\mu\text{A}$	V_{DRM}	600			V
Off-state current	$V_D = V_{DRM}$, $T_{amb} = 100\text{ }^{\circ}\text{C}$, $I_F = 0\text{ mA}$	$I_{D(RMS)}$		10	100	μA
On-state voltage	$I_T = 300\text{ mA}$	V_{TM}		1.7	3.0	V
On-state current	$PF = 1.0$, $V_{T(RMS)} = 1.7\text{ V}$	I_{TM}			300	mA
Surge (non-repetitive), on-state current	$f = 50\text{ Hz}$	I_{TSM}			3.0	A
Trigger current temp. gradient		$\Delta I_{FT1}/\Delta T_j$		7.0	14	$\mu\text{A/K}$
		$\Delta I_{FT2}/\Delta T_j$		7.0	14	$\mu\text{A/K}$
Inhibit voltage temp. gradient		$\Delta V_{DINH}/\Delta T_j$		-20		mV/K
Off-state current in inhibit state	$I_F = I_{FT1}$, V_{DRM}	I_{DINH}		50	200	μA
Holding current		I_H		65	500	μA
Latching current	$V_T = 2.2\text{ V}$	I_L		5.0		mA
Zero cross inhibit voltage	$I_F = \text{Rated } I_{FT}$	V_{IH}		15	25	V
Turn-on time	$V_{RM} = V_{DM} = V_{D(RMS)}$	t_{on}		35		μs
Turn-off time	$PF = 1.0$, $I_T = 300\text{ mA}$	t_{off}		50		μs
Critical rate of rise of off-state voltage	$V_D = 0.67 V_{DRM}$, $T_J = 25\text{ }^{\circ}\text{C}$	dv/dt_{cr}	10000			V/ μs
	$V_D = 0.67 V_{DRM}$, $T_J = 80\text{ }^{\circ}\text{C}$	dv/dt_{cr}	5000			V/ μs
Critical rate of rise of voltage at current commutation	$V_D = 0.67 V_{DRM}$, $di/dt_{crq} \leq 15\text{ A/ms}$, $T_J = 25\text{ }^{\circ}\text{C}$	dv/dt_{crq}	10000			V/ μs
	$V_D = 0.67 V_{DRM}$, $di/dt_{crq} \leq 15\text{ A/ms}$, $T_J = 80\text{ }^{\circ}\text{C}$	dv/dt_{crq}	5000			V/ μs
Critical rate of rise of on-state		di/dt_{cr}	8.0			A/ μs
Thermal resistance, junction to ambient		R_{thja}		125		K/W

Coupler

Parameter	Test condition	Symbol	Min	Typ.	Max	Unit
Critical rate of rise of coupled input/output voltage	$I_T = 0 \text{ A}, V_{RM} = V_{DM} = V_{D(RMS)}$	dv_{IO}/dt		10000		V/ μ s
Common mode coupling capacitance		C_{CM}		0.01		pF
Capacitance (input-output)	$f = 1.0 \text{ MHz}, V_{IO} = 0 \text{ V}$	C_{IO}		0.8		pF
Isolation resistance	$V_{IO} = 500 \text{ V}, T_{amb} = 25 \text{ }^\circ\text{C}$	R_{is}		$\geq 10^{12}$		Ω
	$V_{IO} = 500 \text{ V}, T_{amb} = 100 \text{ }^\circ\text{C}$	R_{is}		$\geq 10^{11}$		Ω
Trigger current	$V_D = 5.0 \text{ V}, \text{ F - Versions}$	I_{FT}			1.2	mA
	$V_D = 5.0 \text{ V}, \text{ H - Versions}$	I_{FT}			2.0	mA
	$V_D = 5.0 \text{ V}, \text{ M - Versions}$	I_{FT}			3.0	mA

Power Factor Considerations

A snubber isn't needed to eliminate false operation of the TRIAC driver because of the high static and commutating dv/dt with loads between 1.0 and 0.8 power factors. When inductive loads with power factors less than 0.8 are being driven, include a RC snubber or a single capacitor directly across the device to damp the peak commutating dv/ dt spike. Normally a commutating dv/dt causes a turning-off device to stay on due to the stored energy remaining in the turning-off device.

But in the case of a zero voltage crossing optotriac, the commutating dv/dt spikes can inhibit one half of the TRIAC from turning on. If the spike potential exceeds the inhibit voltage of the zero cross detection circuit, half of the TRIAC will be held off and not turn-on. This hold-off condition can be eliminated by using a snubber or capacitor placed directly across the optotriac as shown in Figure 1. Note that the value of the capacitor increases as a function of the load current.

The hold-off condition also can be eliminated by providing a higher level of LED drive current. The higher LED drive provides a larger photocurrent which causes the phototransistor to turn-on before the commutating spike has activated the zero cross network. Figure 2 shows the relationship of the LED drive for power factors of less than 1.0. The curve shows that if a device requires 1.5 mA for a resistive load, then 1.8 times 2.7 mA) that amount would be required to control an inductive load whose power factor is less than 0.3.

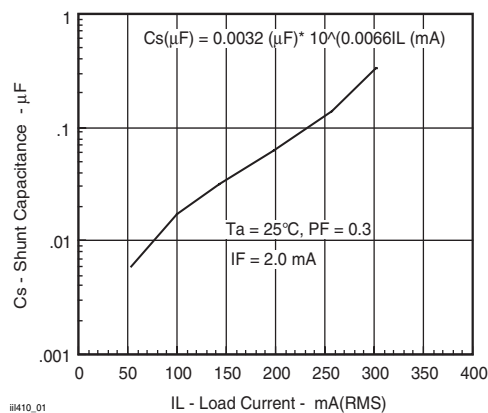

Figure 1. Shunt Capacitance vs. Load Current

Typical Characteristics (Tamb = 25 °C unless otherwise specified)

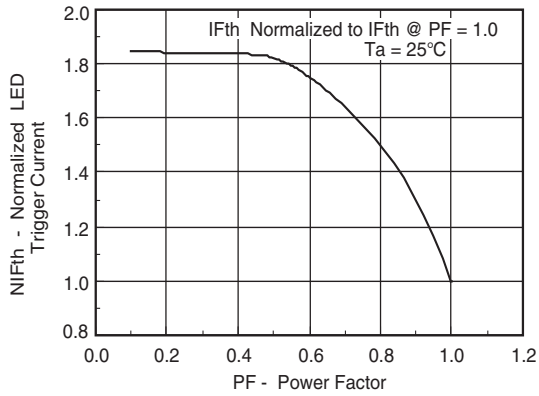

Figure 2. Normalized LED Trigger Current vs. Power Factor

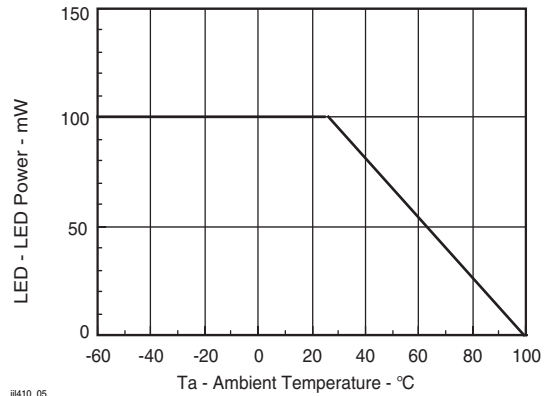

Figure 5. Maximum LED Power Dissipation

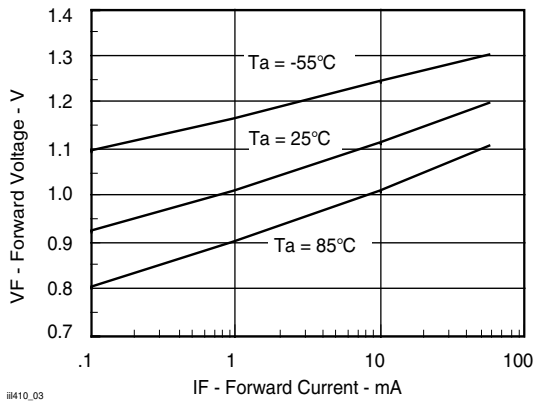

Figure 3. Forward Voltage vs. Forward Current

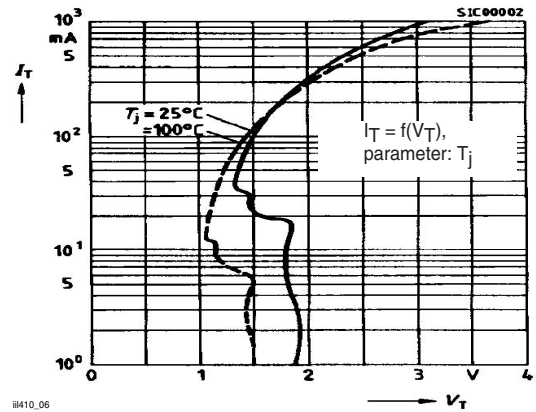

Figure 6. Typical Output Characteristics

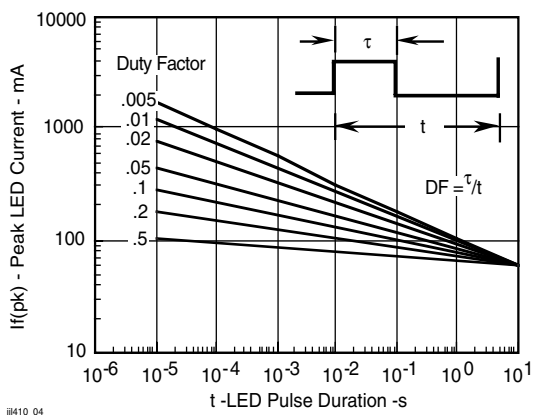

Figure 4. Peak LED Current vs. Duty Factor, Tau

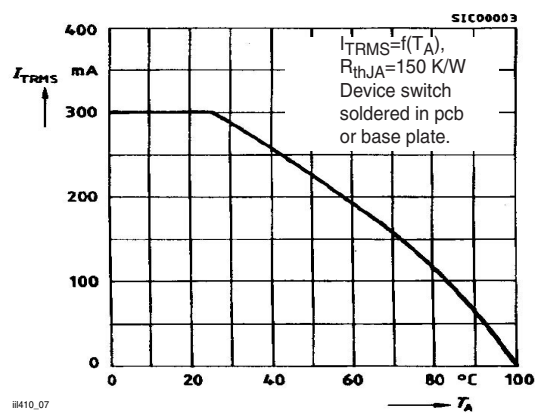

Figure 7. Current Reduction

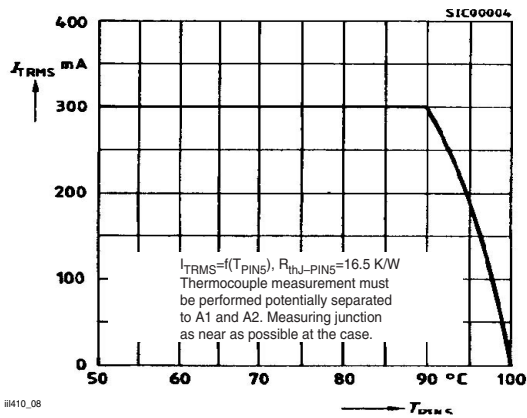

Figure 8. Current Reduction

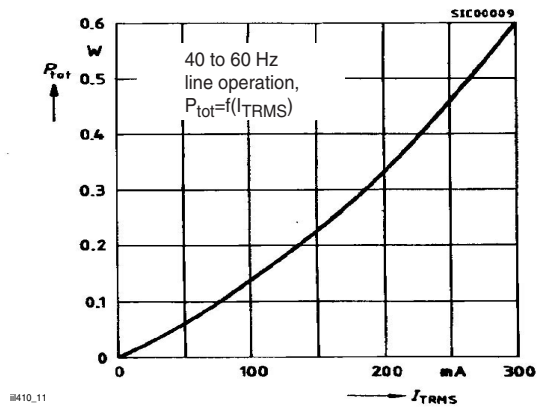

Figure 11. Power Dissipation 40 to 60 Hz Line Operation

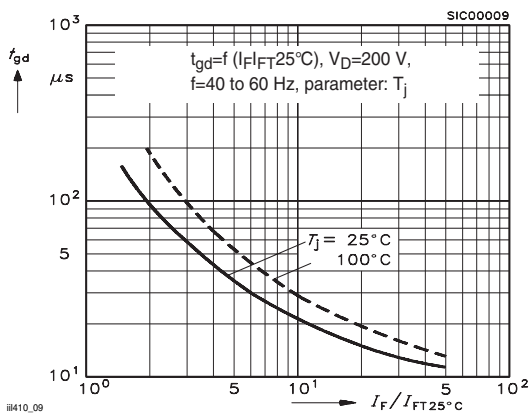

Figure 9. Typical Trigger Delay Time

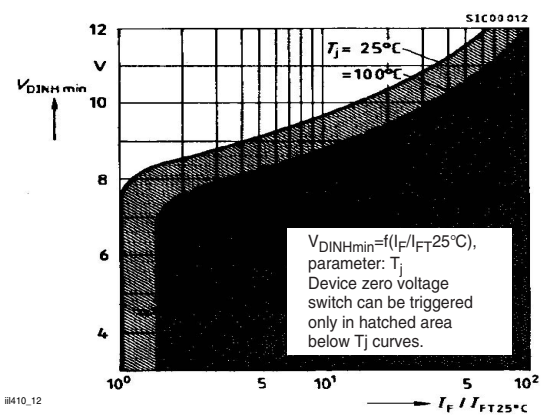

Figure 12. Typical Static Inhibit Voltage Limit

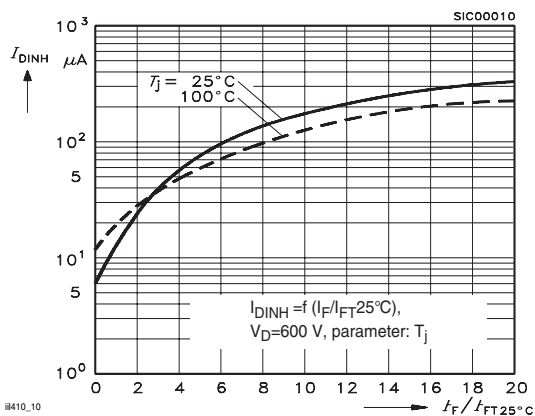

Figure 10. Typical Inhibit Current

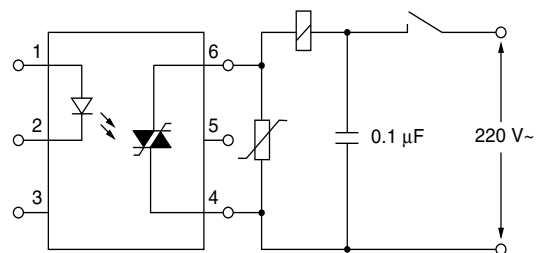
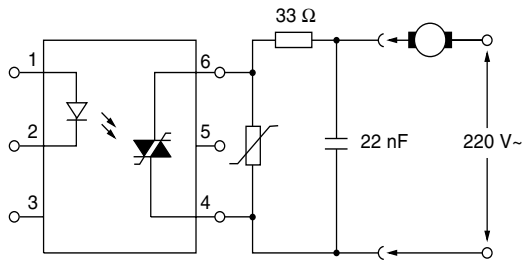
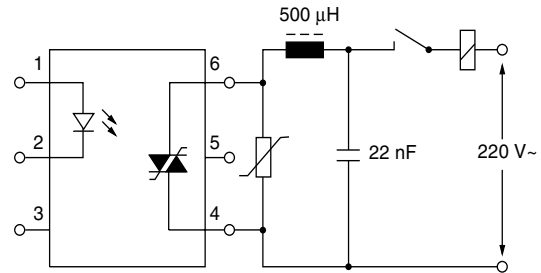

Figure 13. 1- Apply a Capacitor to the Supply Pins at the Load-Side



8410_14

Figure 14. 2 - Connect a Series Resistor to the Output and Bridge Both by a Capacitor



8410_15

Figure 15. 3 - Connect a Choke of Low Winding Cap. in Series, e.g., a Ringcore Choke, with Higher Load Currents

Technical Information

See Application Note for additional information.

Package Dimensions in Inches (mm)

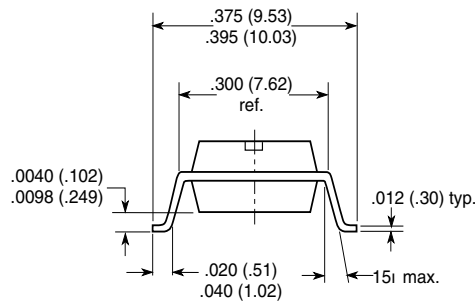
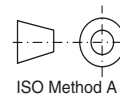
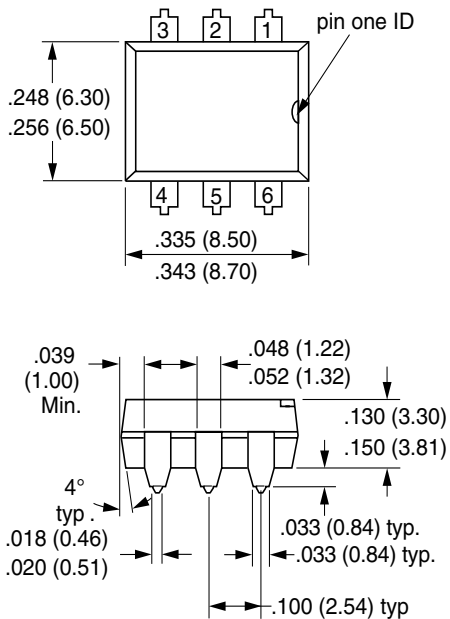

17222

Option 6

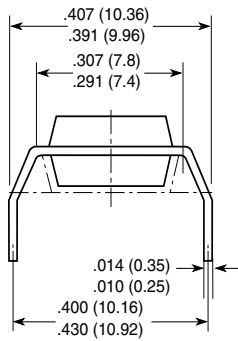

18487

Option 7

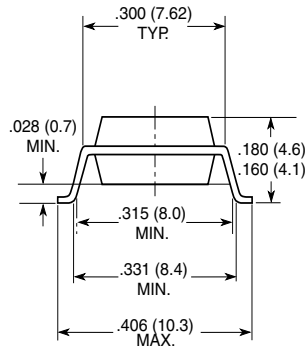

Ozone Depleting Substances Policy Statement

It is the policy of Vishay Semiconductor GmbH to

1. Meet all present and future national and international statutory requirements.
2. Regularly and continuously improve the performance of our products, processes, distribution and operating systems with respect to their impact on the health and safety of our employees and the public, as well as their impact on the environment.

It is particular concern to control or eliminate releases of those substances into the atmosphere which are known as ozone depleting substances (ODSs).

The Montreal Protocol (1987) and its London Amendments (1990) intend to severely restrict the use of ODSs and forbid their use within the next ten years. Various national and international initiatives are pressing for an earlier ban on these substances.

Vishay Semiconductor GmbH has been able to use its policy of continuous improvements to eliminate the use of ODSs listed in the following documents.

1. Annex A, B and list of transitional substances of the Montreal Protocol and the London Amendments respectively
2. Class I and II ozone depleting substances in the Clean Air Act Amendments of 1990 by the Environmental Protection Agency (EPA) in the USA
3. Council Decision 88/540/EEC and 91/690/EEC Annex A, B and C (transitional substances) respectively.

Vishay Semiconductor GmbH can certify that our semiconductors are not manufactured with ozone depleting substances and do not contain such substances.

We reserve the right to make changes to improve technical design and may do so without further notice.

Parameters can vary in different applications. All operating parameters must be validated for each customer application by the customer. Should the buyer use Vishay Semiconductors products for any unintended or unauthorized application, the buyer shall indemnify Vishay Semiconductors against all claims, costs, damages, and expenses, arising out of, directly or indirectly, any claim of personal damage, injury or death associated with such unintended or unauthorized use.

Vishay Semiconductor GmbH, P.O.B. 3535, D-74025 Heilbronn, Germany
Telephone: 49 (0)7131 67 2831, Fax number: 49 (0)7131 67 2423