

TRIACS

DESCRIPTION

Passivated triacs in a plastic envelope, intended for use in applications requiring high bidirectional transient and blocking voltage capability and high thermal cycling performance. Typical applications include motor control, industrial and domestic lighting, heating and static switching.

SYMBOL

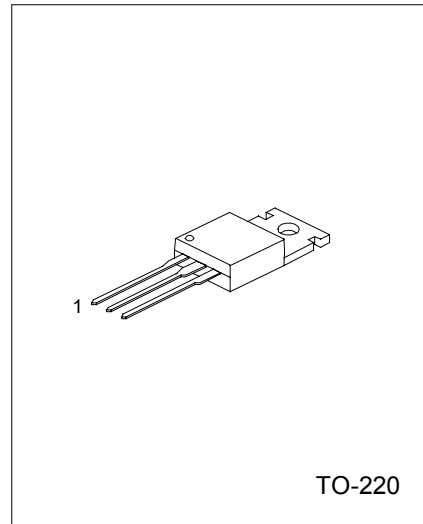
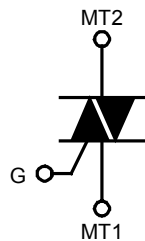

1:MT1 2:MT2 3:GATE

ABSOLUTE MAXIMUM RATINGS

PARAMETER	SYMBOL	RATINGS	UNIT
Repetitive peak off-state voltages BT136-600 BT136-800	V_{DRM}	600* 800	V
RMS on-state current full sine wave; $T_{mb} \leq 107^\circ C$	$I_{T(RMS)}$	4	A
Non-repetitive peak on-state current (Full sine wave; $T_j = 25^\circ C$ prior to surge) t = 20ms t = 16.7 ms	I_{TSM}	25 27	A
I^2t for fusing t = 10 ms	I^2t	3.1	A^2s
Repetitive rate of rise of on-state current after triggering $I_{TM} = 6 A$; $I_G = 0.2A$; $dI_G/dt = 0.2A/\mu s$ T2+G+ T2+G- T2-G- T2-G+	dI_T/dt	50 50 50 10	$A/\mu s$
Peak gate voltage	V_{GM}	5	V
Peak gate current	I_{GM}	2	A
Peak gate power	P_{GM}	5	W
Average gate power (over any 20 ms period)	$P_{G(AV)}$	0.5	W
Storage temperature	T_{stg}	-40 ~ 150	$^\circ C$
Operating junction temperature	T_j	125	$^\circ C$

*Although not recommended, off-state voltages up to 800V may be applied without damage, but the triac may switch to the on-state. The rate of rise of current should not exceed $3A/\mu s$.

THERMAL RESISTANCES

PARAMETER	SYMBOL	MIN	TYP	MAX	UNIT
Thermal resistance Junction to mounting base	R _{th j-mb}			3.0	K/W
Full cycle				3.7	K/W
Thermal resistance Junction to ambient (In free air)	R _{th j-a}		60		K/W

ELECTRICAL CHARACTERISTICS (T_j=25°C, unless otherwise stated)

PARAMETER	SYMBOL	CONDITIONS	MIN	TYP	MAX	UNIT
STATIC CHARACTERISTICS						
Gate trigger current	I _{GT}	V _D = 12 V; I _T = 0.1 A T2+G+ T2+G- T2-G- T2-G+		2.5 4.0 5.0 11	10 10 10 25	mA
Latching current	I _L	V _D = 12 V; I _{GT} = 0.1 A T2+G+ T2+G- T2-G- T2-G+		3.0 10 2.5 4.0	15 20 15 20	mA
Holding current	I _H	V _D = 12 V; I _{GT} = 0.1 A		2.2	15	mA
On-state voltage	V _T	I _T = 5 A		1.4	1.7	V
Gate trigger voltage	V _{GT}	V _D = 12 V; I _T = 0.1 A V _D = 400V ; I _T = 0.1 A; T _j =125°C	0.25	0.7 0.4	1.5	V
Off-state leakage current	I _D	V _D = V _{DRM(max)} ; T _j = 125 °C		0.1	0.5	mA
DYNAMIC CHARACTERISTICS						
Critical rate of rise of Off-state voltage	dV _D /dt	V _{DM} = 67% V _{DRM(max)} ; T _j =125°C; exponential waveform; gate open circuit		50		V/μs
Gate controlled turn-on time	t _{gt}	I _{TM} = 6 A; V _D = V _{DRM(max)} ; I _G =0.1A; dI _G /dt=5A/μs		2		μs

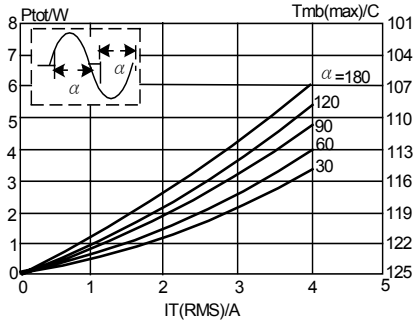

Fig. 1. Maximum on-state dissipation, P_{tot} versus rms on-state current, $I_T(RMS)$ where α = conduction angle.

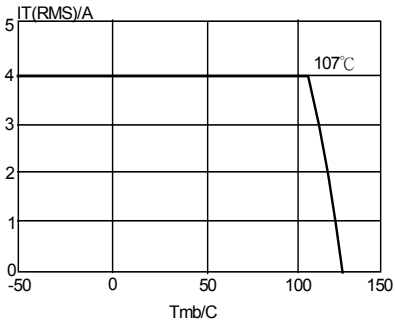

Fig. 4. Maximum permissible rms current $I_T(RMS)$, versus mounting base temperature T_{mb}

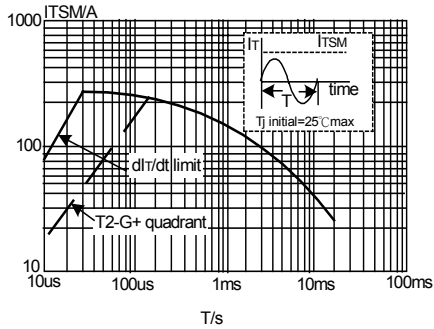

Fig. 2. Maximum Permissible non-repetitive peak on-state Current I_{TSM} , versus pulse width t_p for sinusoidal currents, $t_p \leq 20ms$

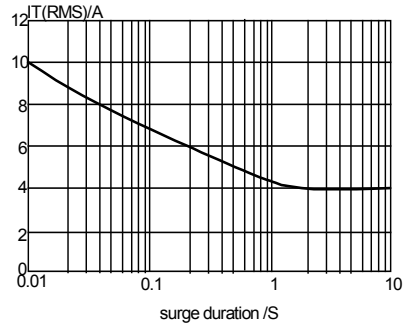

Fig. 5. Maximum permissible repetitive rms on-state current $I_T(RMS)$, versus surge duration, for sinusoidal currents, $f=50HZ$; $T_{mb} \leq 107^\circ C$

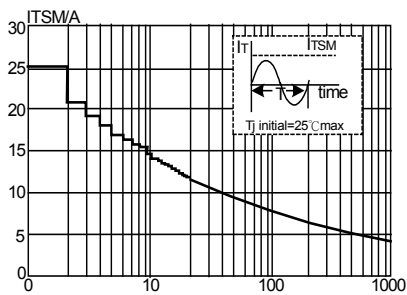

Fig. 3. Maximum Permissible non-repetitive peak on-state current I_{TSM} , versus number of cycles, for sinusoidal currents, $f=50HZ$.

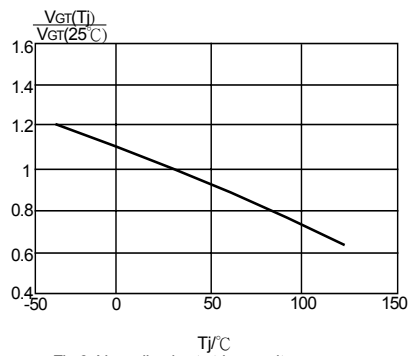

Fig. 6. Normalised gate trigger voltage $V_{GT}(T_j)/V_{GT}(25^\circ C)$, versus junction temperature T_j

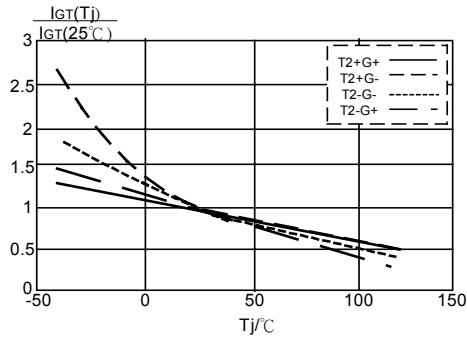

Fig. 7. Normalised gate trigger Current $I_{GT}(T_j)/I_{GT}(25^\circ\text{C})$, versus junction temperature T_j

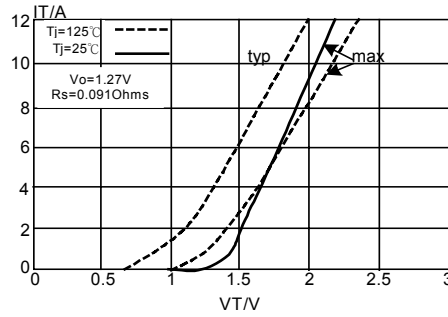

Fig. 10. Typical and maximum on-state characteristic.

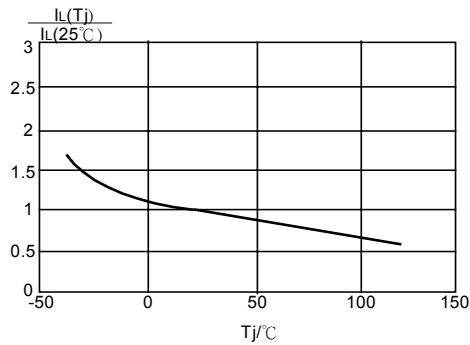

Fig. 8. Normalised latching Current $I_L(T_j)/I_L(25^\circ\text{C})$, versus junction temperature T_j

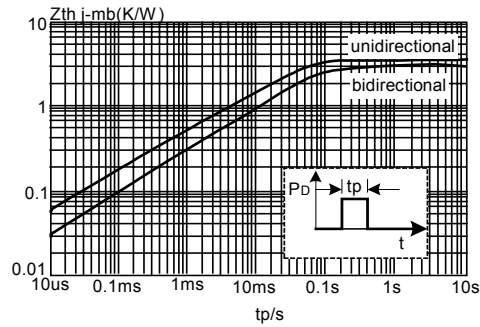

Fig. 11. Transient thermal impedance Z_{thj-mb} , versus pulse width t_p .

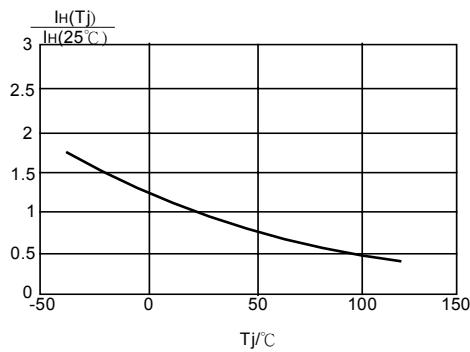

Fig. 9. Normalised holding current $I_H(T_j)/I_H(25^\circ\text{C})$, versus junction temperature T_j

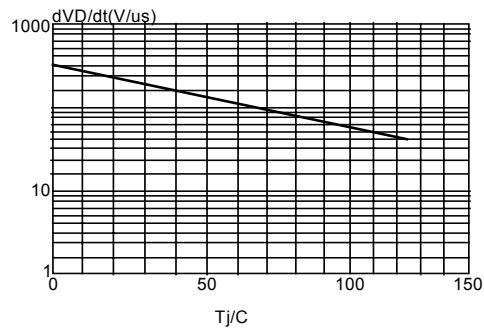

Fig. 12. Typical, critical rate of rise of off-state voltage, dV_D/dt versus junction temperature T_j

UTC assumes no responsibility for equipment failures that result from using products at values that exceed, even momentarily, rated values (such as maximum ratings, operating condition ranges, or other parameters) listed in products specifications of any and all UTC products described or contained herein. UTC products are not designed for use in life support appliances, devices or systems where malfunction of these products can be reasonably expected to result in personal injury. Reproduction in whole or in part is prohibited without the prior written consent of the copyright owner. The information presented in this document does not form part of any quotation or contract, is believed to be accurate and reliable and may be changed without notice.