

Features

- N channel
- Enhancement mode
- Temperature sensor with thyristor characteristic
- The drain pin is electrically shorted to the tab

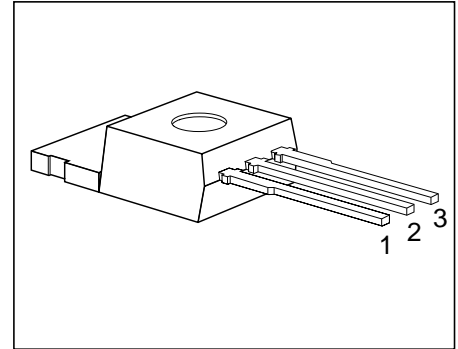

| Pin | 1 | 2 | 3 |
|-----|---|---|---|
| | G | D | S |

| Type | V_{DS} | I_D | $R_{DS(on)}$ | Package | Ordering Code |
|---------|----------|-------|---------------|----------|-----------------|
| BTS 130 | 50 V | 27 A | 0.05 Ω | TO-220AB | C67078-A5001-A3 |

Maximum Ratings

| Parameter | Symbol | Values | Unit |
|---|----------------------|------------------|-------------------|
| Drain-source voltage | V_{DS} | 50 | V |
| Drain-gate voltage, $R_{GS} = 20 \text{ k}\Omega$ | V_{DGR} | 50 | |
| Gate-source peak voltage, aperiodic | V_{gs} | ± 20 | |
| Continuous drain current, $T_C = 25^\circ \text{C}$ | I_D | 27 | A |
| ISO drain current $T_C = 85^\circ \text{C}$, $V_{GS} = 10 \text{ V}$, $V_{DS} = 0.5 \text{ V}$ | I_{D-ISO} | 7.5 | |
| Pulsed drain current, $T_C = 25^\circ \text{C}$ | $I_{D \text{ puls}}$ | 108 | |
| Short circuit current, $T_j = -55 \dots +150^\circ \text{C}$ | I_{SC} | 80 | |
| Short circuit dissipation, $T_j = -55 \dots +150^\circ \text{C}$ | P_{SCmax} | 1200 | W |
| Power dissipation | P_{tot} | 75 | |
| Operating and storage temperature range | T_j, T_{stg} | $-55 \dots +150$ | $^\circ \text{C}$ |
| DIN humidity category, DIN 40 040 | – | E | – |
| IEC climatic category, DIN IEC 68-1 | – | 55/150/56 | |
| Thermal resistance | | | K/W |
| Chip-case | $R_{th \text{ JC}}$ | ≤ 1.67 | |
| Chip-ambient | $R_{th \text{ JA}}$ | ≤ 75 | |

Electrical Characteristics

at $T_j = 25\text{ °C}$, unless otherwise specified.

| Parameter | Symbol | Values | | | Unit |
|-----------|--------|--------|------|------|------|
| | | min. | typ. | max. | |

Static Characteristics

| | | | | | |
|---|---------------|--------|----------|-----------|---------------------|
| Drain-source breakdown voltage $V_{GS} = 0, I_D = 0.25\text{ mA}$ | $V_{(BR)DSS}$ | 50 | – | – | V |
| Gate threshold voltage $V_{GS} = V_{DS}, I_D = 1\text{ mA}$ | $V_{GS(th)}$ | 2.5 | 3.0 | 3.5 | |
| Zero gate voltage drain current $V_{GS} = 0\text{ V}, V_{DS} = 50\text{ V}$ $T_j = 25\text{ °C}$ $T_j = 125\text{ °C}$ | I_{DSS} | – – | 1 100 | 10 300 | μA |
| Gate-source leakage current $V_{GS} = 20\text{ V}, V_{DS} = 0$ $T_j = 25\text{ °C}$ $T_j = 150\text{ °C}$ | I_{GSS} | – – | 10 2 | 100 4 | nA μA |
| Drain-source on-state resistance $V_{GS} = 10\text{ V}, I_D = 17\text{ A}$ | $R_{DS(on)}$ | – | 0.04 | 0.05 | Ω |

Dynamic Characteristics

| | | | | | |
|---|--------------|-----|------|------|---------------|
| Forward transconductance $V_{DS} \geq 2 \times I_D \times R_{DS(on)max}, I_D = 17\text{ A}$ | g_{fs} | 8.0 | 13.0 | 18.0 | S |
| Input capacitance $V_{GS} = 0, V_{DS} = 25\text{ V}, f = 1\text{ MHz}$ | C_{iss} | 700 | 940 | 1250 | μF |
| Output capacitance $V_{GS} = 0, V_{DS} = 25\text{ V}, f = 1\text{ MHz}$ | C_{oss} | – | 500 | 750 | |
| Reverse transfer capacitance $V_{GS} = 0, V_{DS} = 25\text{ V}, f = 1\text{ MHz}$ | C_{rss} | – | 180 | 270 | |
| Turn-on time t_{on} , ($t_{on} = t_{d(on)} + t_r$) $V_{CC} = 30\text{ V}, V_{GS} = 10\text{ V}, I_D = 3\text{ A}, R_{GS} = 50\text{ }\Omega$ | $t_{d(on)}$ | – | 25 | 40 | ns |
| | t_r | – | 60 | 90 | |
| Turn-off time t_{off} , ($t_{off} = t_{d(off)} + t_f$) $V_{CC} = 30\text{ V}, V_{GS} = 10\text{ V}, I_D = 3\text{ A}, R_{GS} = 50\text{ }\Omega$ | $t_{d(off)}$ | – | 100 | 130 | |
| | t_f | – | 75 | 95 | |

Electrical Characteristics (cont'd)

at $T_j = 25\text{ °C}$, unless otherwise specified.

| Parameter | Symbol | Values | | | Unit |
|-----------|--------|--------|------|------|------|
| | | min. | typ. | max. | |

Reverse Diode

| | | | | | |
|---|----------|---|-----|-----|---------------|
| Continuous source current | I_S | – | – | 27 | A |
| Pulsed source current | I_{SM} | – | – | 108 | |
| Diode forward on-voltage $I_F = 54\text{ A}$, $V_{GS} = 0$ | V_{SD} | – | 1.5 | 2.0 | V |
| Reverse recovery time $I_F = I_S$, $di_F/dt = 100\text{ A}/\mu\text{s}$, $V_R = 30\text{ V}$ | t_{rr} | – | 150 | – | ns |
| Reverse recovery charge $I_F = I_S$, $di_F/dt = 100\text{ A}/\mu\text{s}$, $V_R = 30\text{ V}$ | Q_{rr} | – | 1.0 | – | μC |

Temperature Sensor

| | | | | | |
|---|--------------|--------------|------------|------------|--------------------|
| Forward voltage $I_{TS(on)} = 10\text{ mA}$, $T_j = -55 \dots +150\text{ °C}$ Sensor override, $t_p \leq 100\text{ }\mu\text{s}$ $T_j = -55 \dots +160\text{ °C}$ | $V_{TS(on)}$ | – | 1.4 | 1.5 | V |
| | | – | – | 10 | |
| Forward current $T_j = -55 \dots +150\text{ °C}$ Sensor override, $t_p \leq 100\text{ }\mu\text{s}$ $T_j = -55 \dots +160\text{ °C}$ | $I_{TS(on)}$ | – | – | 10 | mA |
| | | – | – | 600 | |
| Holding current, $V_{TS(off)} = 5\text{ V}$, $T_j = 25\text{ °C}$ $T_j = 150\text{ °C}$ | I_H | 0.05 0.05 | 0.1 0.2 | 0.5 0.3 | |
| Switching temperature $V_{TS} = 5\text{ V}$ | $T_{TS(on)}$ | 150 | – | – | $^{\circ}\text{C}$ |
| Turn-off time $V_{TS} = 5\text{ V}$, $I_{TS(on)} = 2\text{ mA}$ | t_{off} | 0.5 | – | 2.5 | μs |

Examples for short-circuit protection

at $T_j = -55 \dots +150 \text{ }^\circ\text{C}$, unless otherwise specified.

| Parameter | Symbol | Examples | | | Unit |
|---|---------------|-----------|-----------|---|------|
| | | 1 | 2 | – | |
| Drain-source voltage | V_{DS} | 15 | 30 | – | V |
| Gate-source voltage | V_{GS} | 8.1 | 5.9 | – | |
| Short-circuit current | I_{SC} | ≤ 80 | ≤ 37 | – | A |
| Short-circuit dissipation | P_{SC} | 1200 | 1100 | – | W |
| Response time $T_j = 25 \text{ }^\circ\text{C}$, before short circuit | $t_{SC(off)}$ | 25 | 25 | – | ms |

Short-circuit protection $I_{SC} = f(V_{DS})$

Parameter: V_{GS}

Diagram to determine I_{SC} for $T_j = -55 \dots +150 \text{ }^\circ\text{C}$

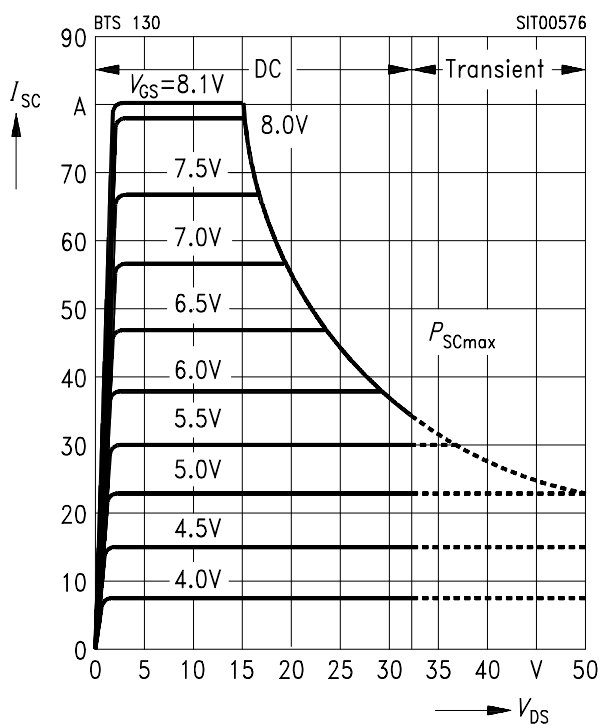

Max. gate voltage $V_{GS(SC)} = f(V_{DS})$

Parameter: $T_j = -55 \dots +150 \text{ }^\circ\text{C}$

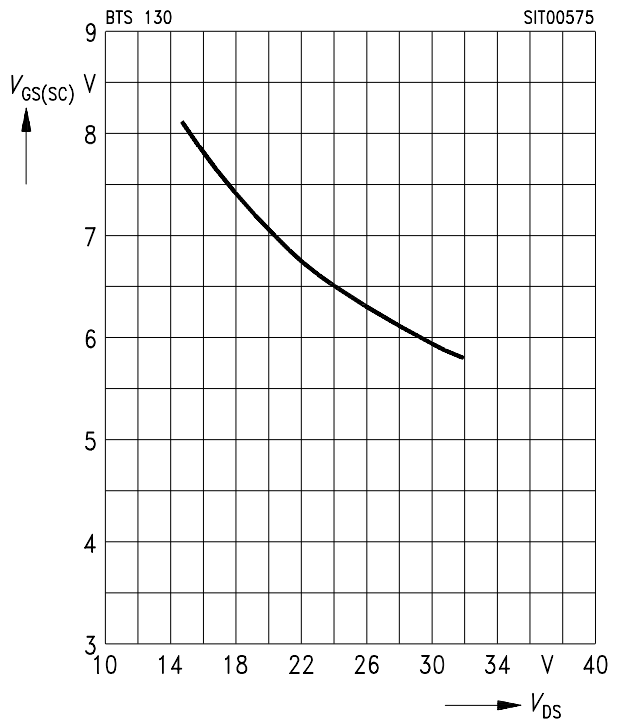

Max. power dissipation $P_{tot} = f(T_C)$

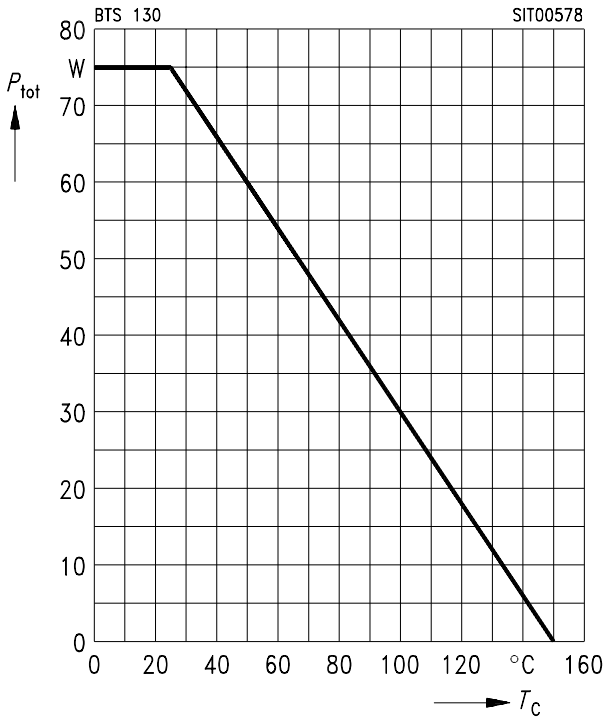

Typ. drain-source on-state resistance $R_{DS(on)} = f(I_D)$

Parameter: V_{GS}

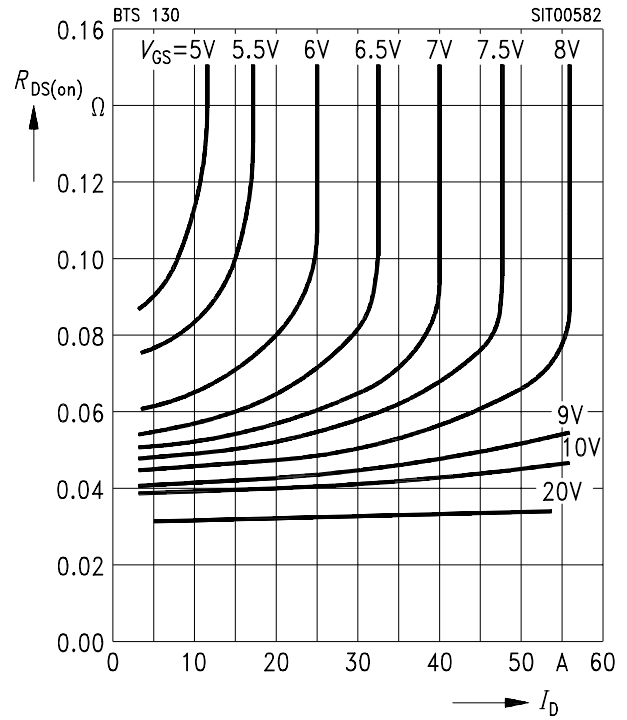

Typical output characteristics $I_D = f(V_{DS})$

Parameter: $t_p = 80 \mu s$

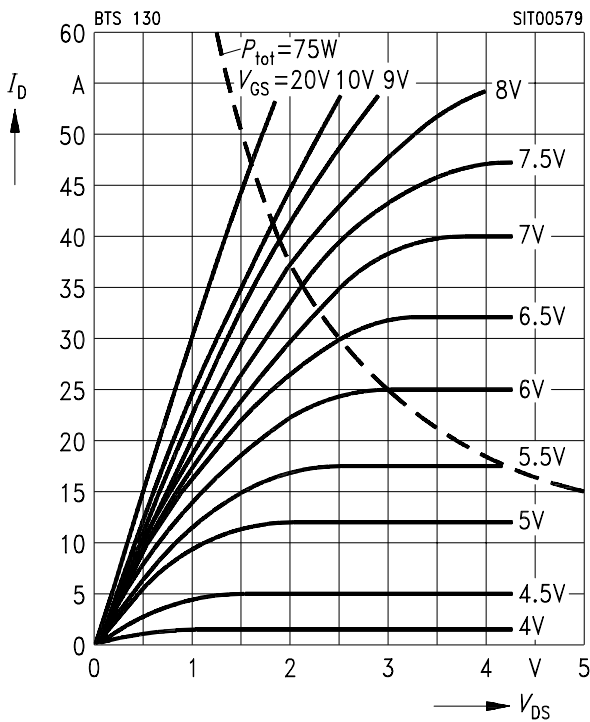

Safe operating area $I_D = f(V_{DS})$

Parameter: $D = 0.01, T_C = 25 \text{ }^\circ\text{C}$

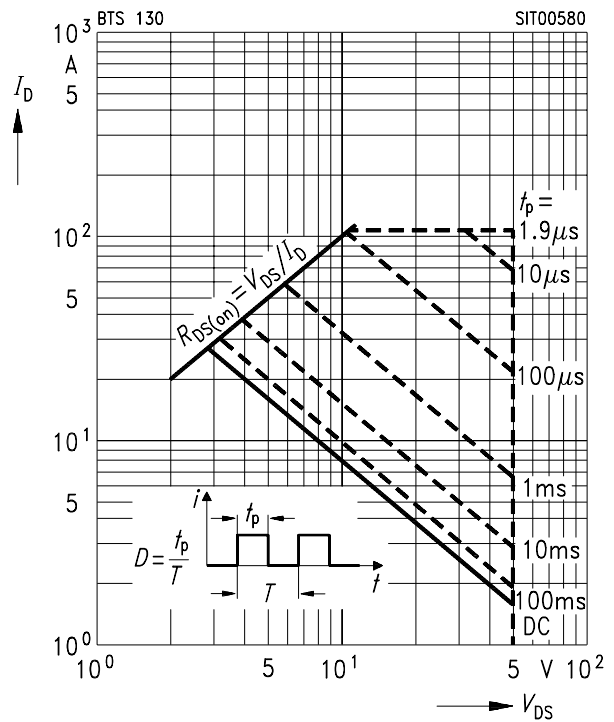

Drain-source on-state resistance

$R_{DS(on)} = f(T_j)$

Parameter: $I_D = 17 \text{ A}$, $V_{GS} = 10 \text{ V}$ (spread)

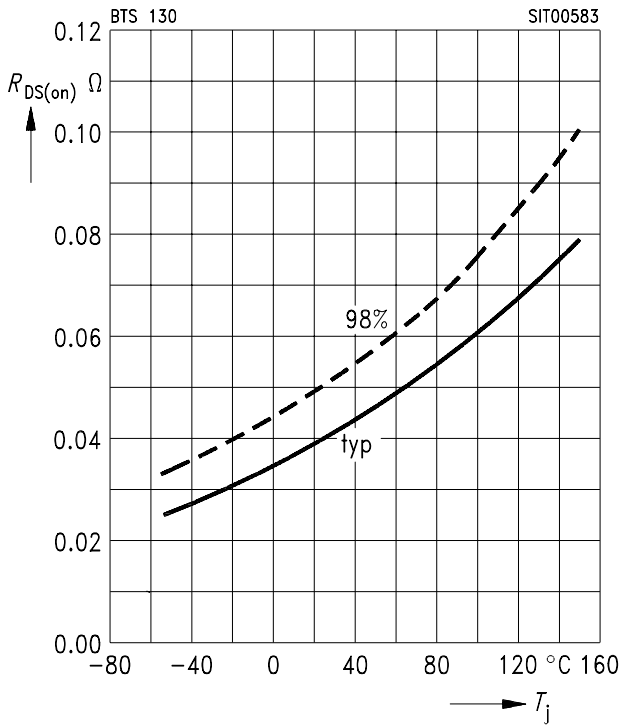

Gate threshold voltage $V_{GS(th)} = f(T_j)$

Parameter: $V_{DS} = V_{GS}$, $I_D = 1 \text{ mA}$

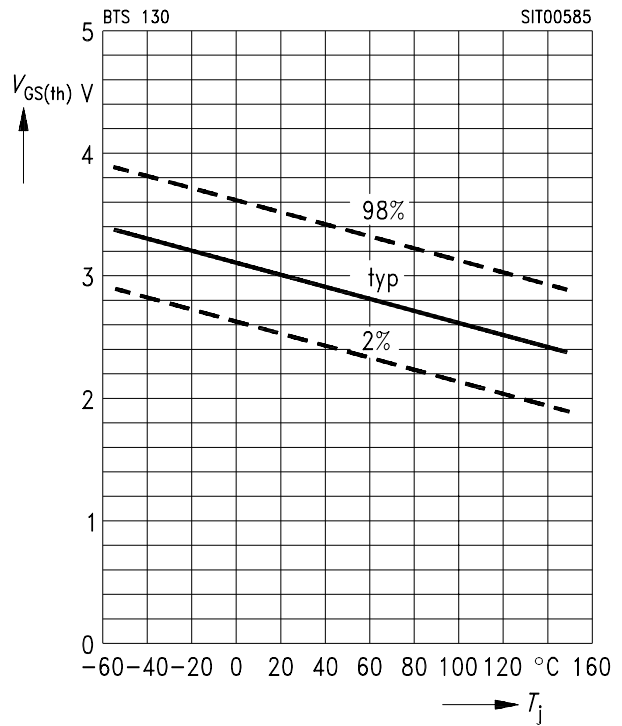

Typ. transfer characteristic

$I_D = f(V_{GS})$

Parameter: $t_p = 80 \mu\text{s}$, $V_{DS} = 25 \text{ V}$

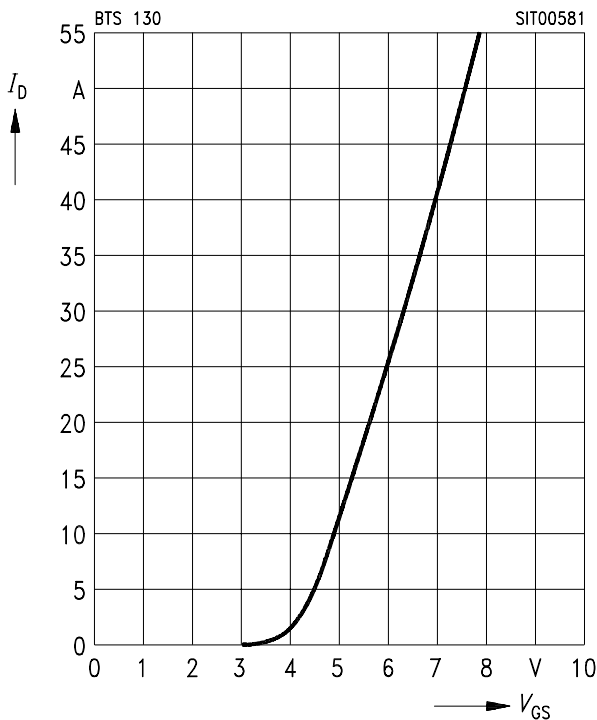

Typ. transconductance $g_{fs} = f(I_D)$

Parameter: $t_p = 80 \mu\text{s}$, $V_{DS} = 25 \text{ V}$

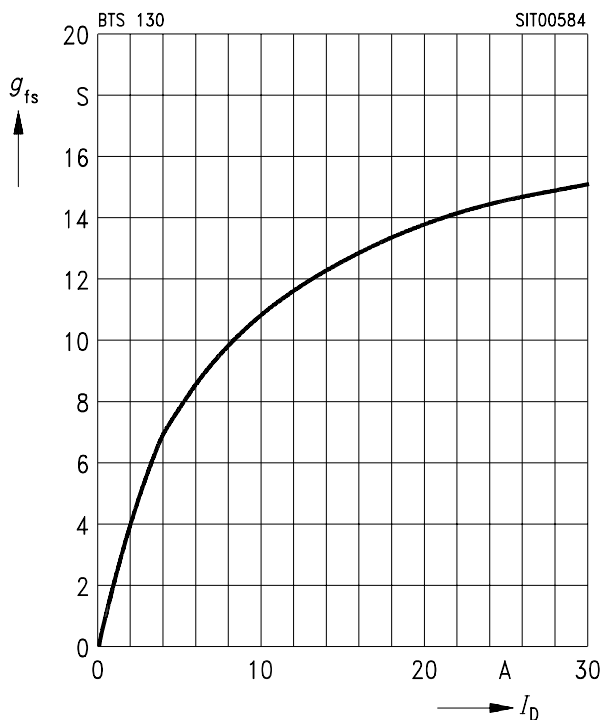

Continuous drain current $I_D = f(T_C)$

Parameter: $V_{GS} \geq 10\text{ V}$

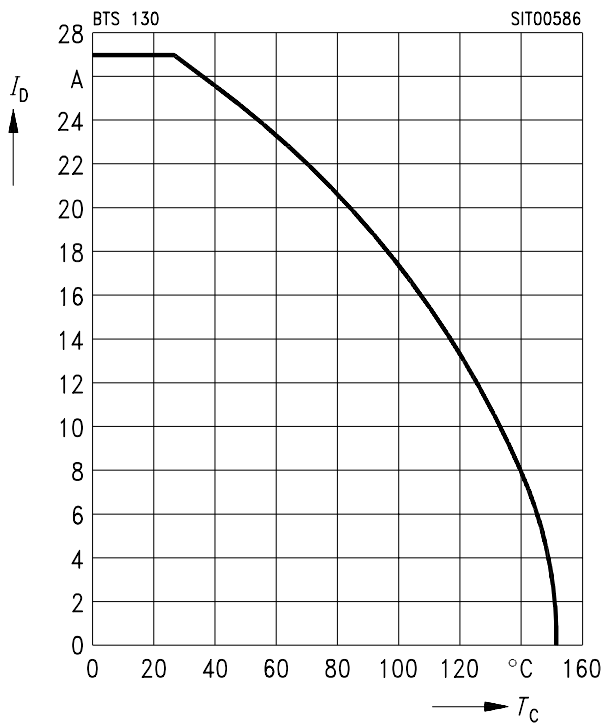

Forward characteristics of reverse diode $I_F = f(V_{SD})$

Parameter: $T_j, t_p = 80\ \mu\text{s}$ (spread)

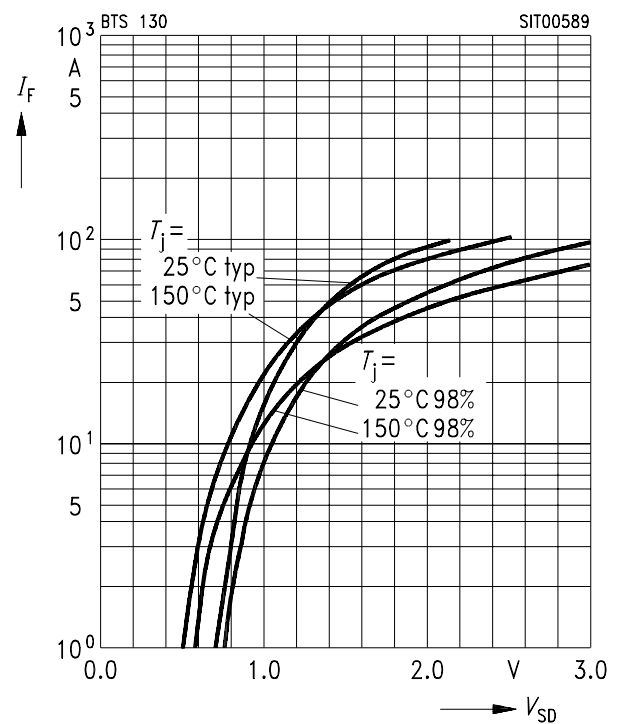

Typ. gate-source leakage current $I_{GSS} = f(T_C)$

Parameter: $V_{GS} = 20\text{ V}, V_{DS} = 0$

Parameter: $V_{GS} = 20\text{ V}, V_{DS} = 0$

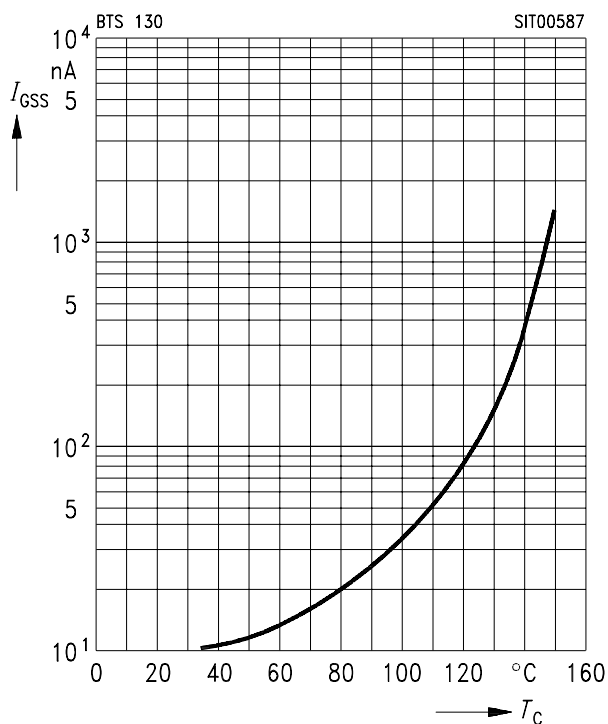

Typ. capacitances $C = f(V_{DS})$

Parameter: $V_{GS} = 0, f = 1\text{ MHz}$

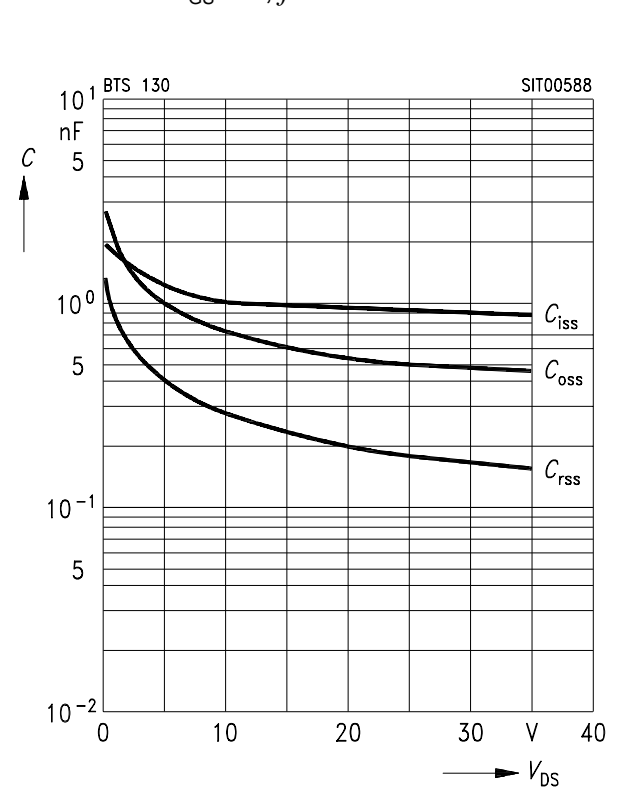

Transient thermal impedance $Z_{thJC} = f(t_p)$
Parameter: $D = t_p/T$

