

PowerMOS transistor

BUK436W-800A/B

GENERAL DESCRIPTION

N-channel enhancement mode field-effect power transistor in a plastic envelope.
 The device is intended for use in Switched Mode Power Supplies (SMPS), motor control, welding, DC/DC and AC/DC converters, and in general purpose switching applications.

QUICK REFERENCE DATA

SYMBOL	PARAMETER	MAX.	MAX.	UNIT
	BUK436	-800A	-800B	
V_{DS}	Drain-source voltage	800	800	V
I_D	Drain current (DC)	4	3.5	A
P_{tot}	Total power dissipation	125	125	W
$R_{DS(ON)}$	Drain-source on-state resistance	3	4	Ω

PINNING - SOT429 (TO247)

PIN	DESCRIPTION
1	gate
2	drain
3	source
tab	drain

PIN CONFIGURATION

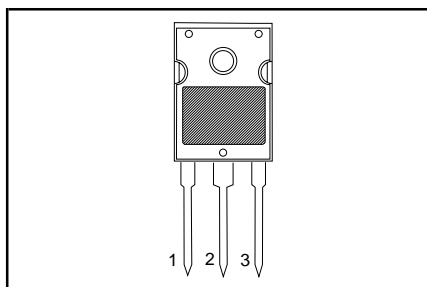

SYMBOL

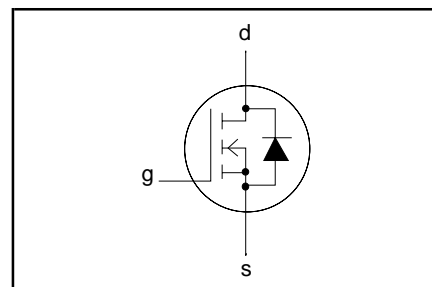

LIMITING VALUES

Limiting values in accordance with the Absolute Maximum System (IEC 134)

SYMBOL	PARAMETER	CONDITIONS	MIN.	MAX.	UNIT
V_{DS}	Drain-source voltage	-	-	800	V
V_{DGR}	Drain-gate voltage	$R_{GS} = 20\text{ k}\Omega$	-	800	V
$\pm V_{GS}$	Gate-source voltage	-	-	30	V
I_D	Drain current (DC)	$T_{mb} = 25\text{ }^\circ\text{C}$	-	-800A 4.0	A
I_D	Drain current (DC)	$T_{mb} = 100\text{ }^\circ\text{C}$	-	2.5	A
I_{DM}	Drain current (pulse peak value)	$T_{mb} = 25\text{ }^\circ\text{C}$	-	16	A
P_{tot}	Total power dissipation	$T_{mb} = 25\text{ }^\circ\text{C}$	-	125	W
T_{stg}	Storage temperature	-	- 55	150	$^\circ\text{C}$
T_j	Junction temperature	-	-	150	$^\circ\text{C}$

THERMAL RESISTANCES

SYMBOL	PARAMETER	CONDITIONS	MIN.	TYP.	MAX.	UNIT
$R_{th\ j-mb}$	Thermal resistance junction to mounting base		-	-	1.0	K/W
$R_{th\ j-a}$	Thermal resistance junction to ambient		-	45	-	K/W

PowerMOS transistor

BUK436W-800A/B

STATIC CHARACTERISTICS $T_{mb} = 25\text{ °C}$ unless otherwise specified

SYMBOL	PARAMETER	CONDITIONS	MIN.	TYP.	MAX.	UNIT
$V_{(BR)DSS}$	Drain-source breakdown voltage	$V_{GS} = 0\text{ V}; I_D = 0.25\text{ mA}$	800	-	-	V
$V_{GS(TO)}$	Gate threshold voltage	$V_{DS} = V_{GS}; I_D = 1\text{ mA}$	2.1	3.0	4.0	V
I_{DSS}	Zero gate voltage drain current	$V_{DS} = 800\text{ V}; V_{GS} = 0\text{ V}; T_j = 25\text{ °C}$	-	2	20	μA
I_{DSS}	Zero gate voltage drain current	$V_{DS} = 800\text{ V}; V_{GS} = 0\text{ V}; T_j = 125\text{ °C}$	-	0.1	1.0	mA
I_{GSS}	Gate source leakage current	$V_{GS} = \pm 30\text{ V}; V_{DS} = 0\text{ V}$	-	10	100	nA
$R_{DS(ON)}$	Drain-source on-state resistance	$V_{GS} = 10\text{ V}; I_D = 1.5\text{ A}$	-	2.7	3.0	Ω
		BUK436-800A	-	3.5	4.0	Ω
		BUK436-800B	-			

DYNAMIC CHARACTERISTICS $T_{mb} = 25\text{ °C}$ unless otherwise specified

SYMBOL	PARAMETER	CONDITIONS	MIN.	TYP.	MAX.	UNIT
g_{fs}	Forward transconductance	$V_{DS} = 25\text{ V}; I_D = 1.5\text{ A}$	3.0	4.3	-	S
C_{iss}	Input capacitance	$V_{GS} = 0\text{ V}; V_{DS} = 25\text{ V}; f = 1\text{ MHz}$	-	1000	1250	pF
C_{oss}	Output capacitance		-	80	120	pF
C_{rss}	Feedback capacitance		-	30	50	pF
t_{don}	Turn-on delay time	$V_{DD} = 30\text{ V}; I_D = 2.3\text{ A};$ $V_{GS} = 10\text{ V}; R_{GS} = 50\text{ }\Omega;$ $R_{gen} = 50\text{ }\Omega$	-	10	25	ns
t_r	Turn-on rise time		-	25	40	ns
t_{doff}	Turn-off delay time		-	130	150	ns
t_f	Turn-off fall time		-	40	60	ns
L_d	Internal drain inductance	Measured from contact screw on tab to centre of die	-	5	-	nH
L_d	Internal drain inductance	Measured from drain lead 6 mm from package to centre of die	-	5	-	nH
L_s	Internal source inductance	Measured from source lead 6 mm from package to source bond pad	-	12.5	-	nH

REVERSE DIODE LIMITING VALUES AND CHARACTERISTICS $T_{mb} = 25\text{ °C}$ unless otherwise specified

SYMBOL	PARAMETER	CONDITIONS	MIN.	TYP.	MAX.	UNIT
I_{DR}	Continuous reverse drain current	-	-	-	4.0	A
I_{DRM}	Pulsed reverse drain current	-	-	-	16	A
V_{SD}	Diode forward voltage	$I_F = 4.0\text{ A}; V_{GS} = 0\text{ V}$	-	1.0	1.3	V
t_{rr}	Reverse recovery time	$I_F = 4.0\text{ A}; -di_F/dt = 100\text{ A}/\mu\text{s};$	-	1800	-	ns
Q_{rr}	Reverse recovery charge	$V_{GS} = 0\text{ V}; V_R = 100\text{ V}$	-	12	-	μC

PowerMOS transistor

BUK436W-800A/B

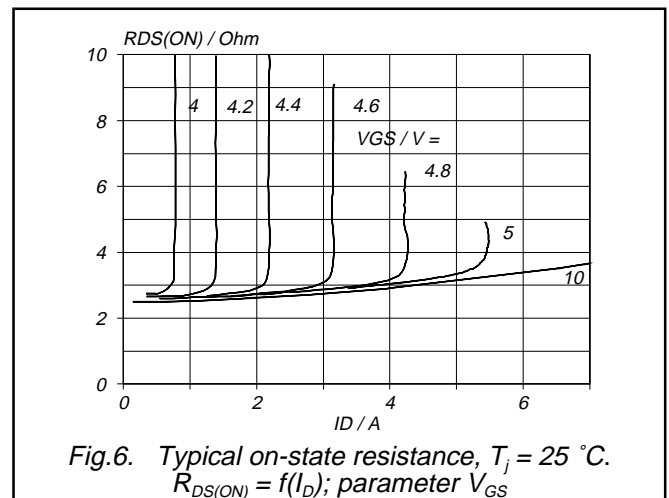
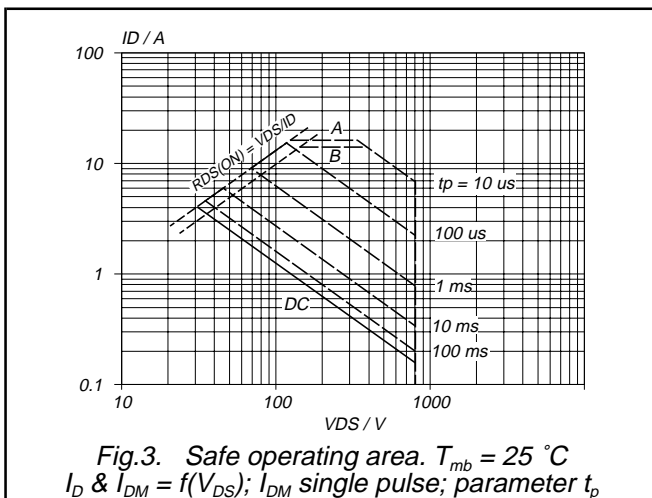
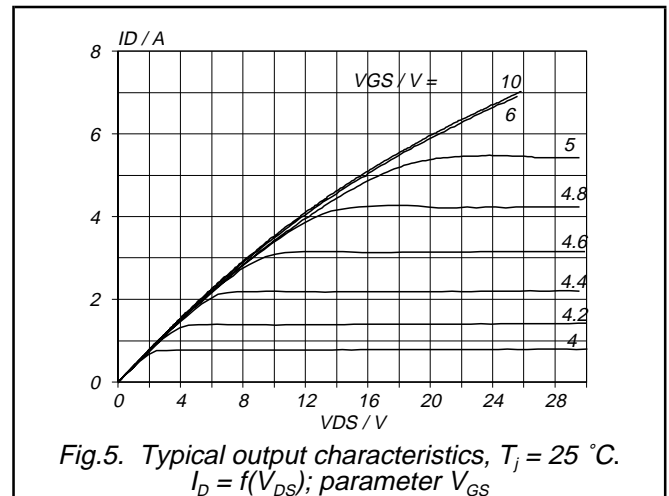
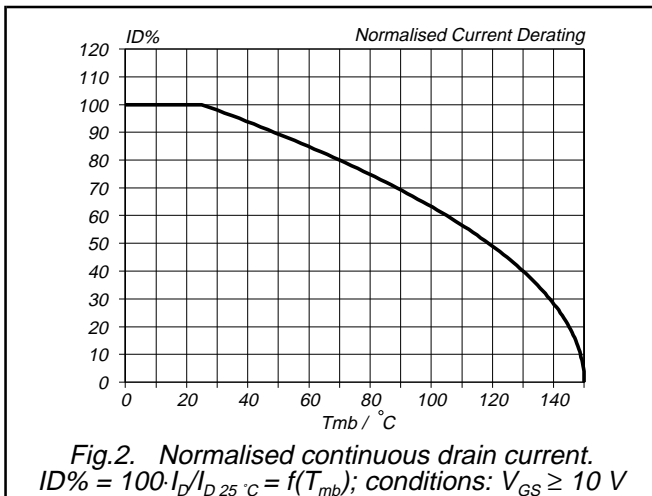
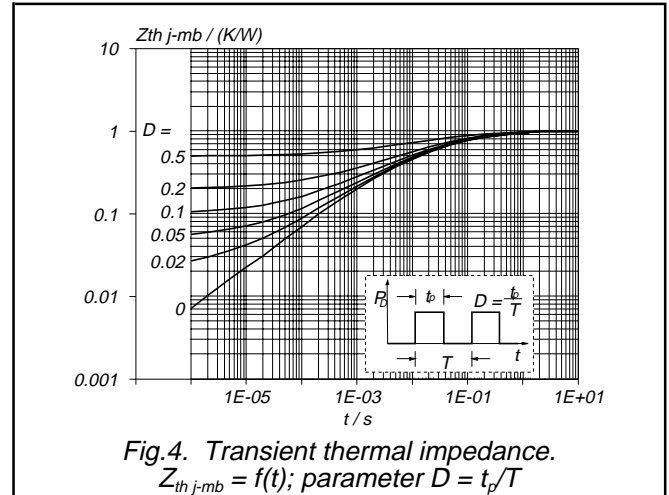
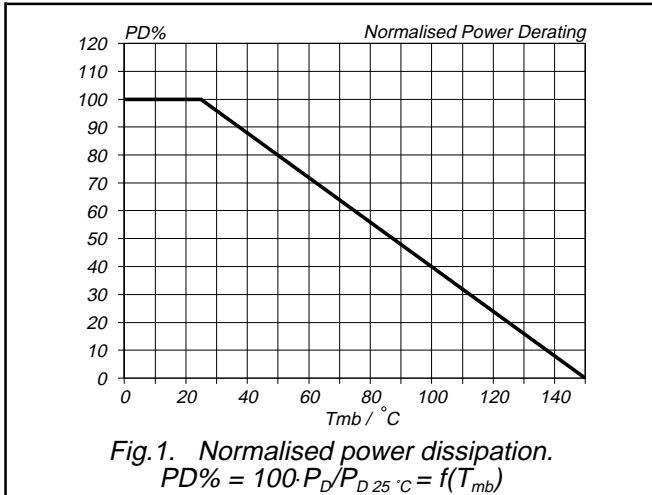

PowerMOS transistor

BUK436W-800A/B

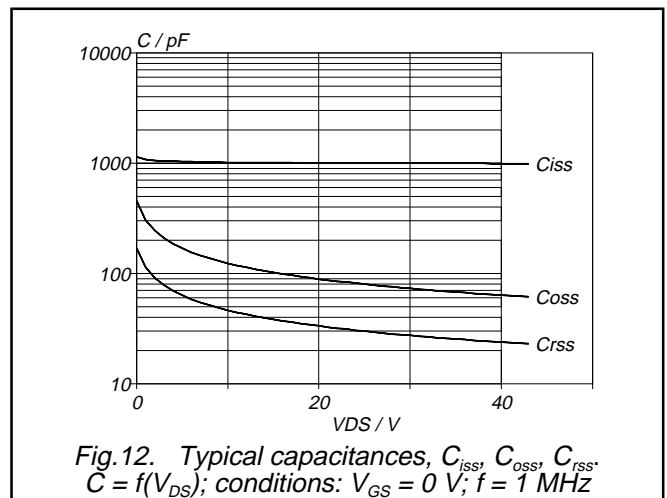
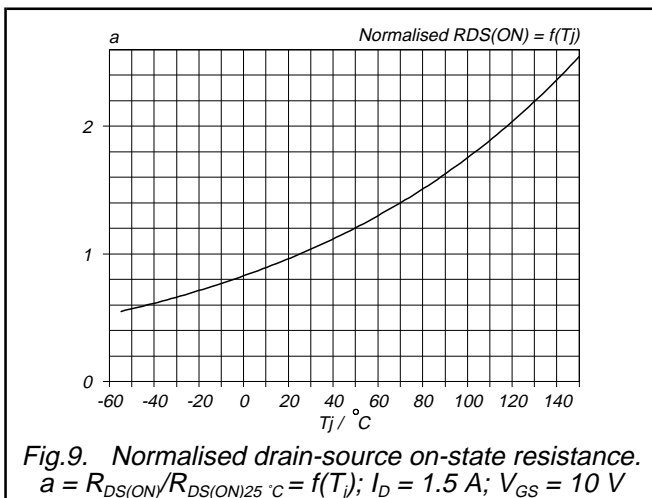
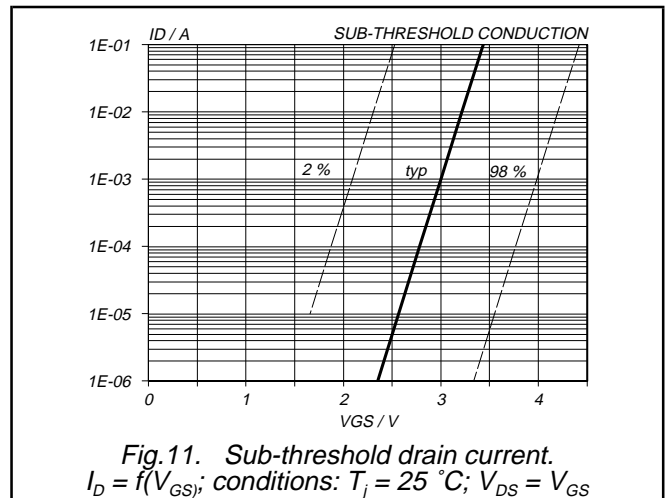
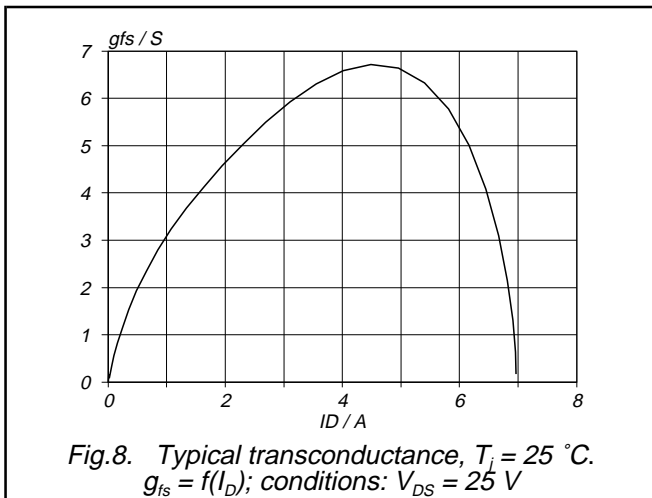
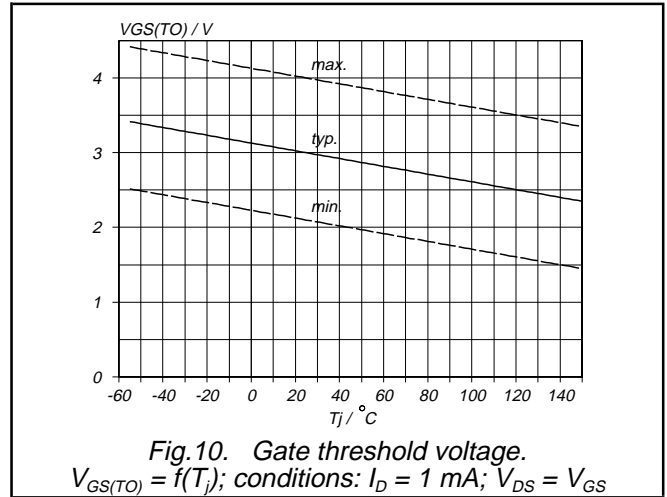
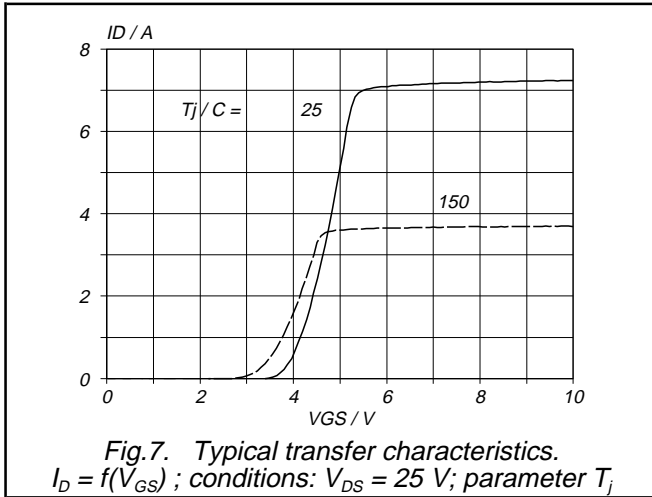

PowerMOS transistor

BUK436W-800A/B

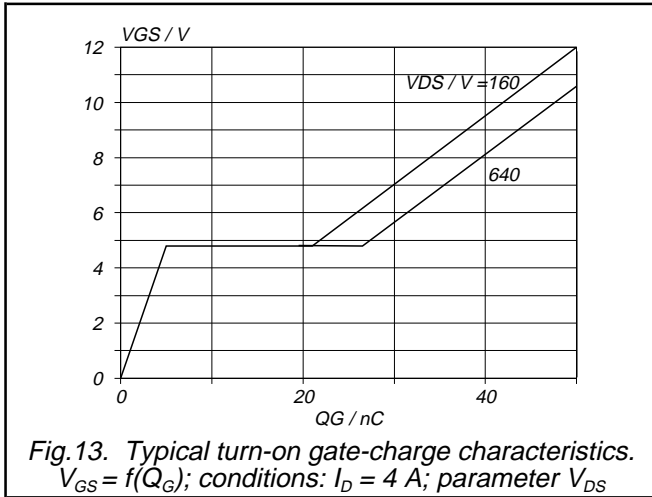

Fig.13. Typical turn-on gate-charge characteristics.
 $V_{GS} = f(Q_G)$; conditions: $I_D = 4$ A; parameter V_{DS}

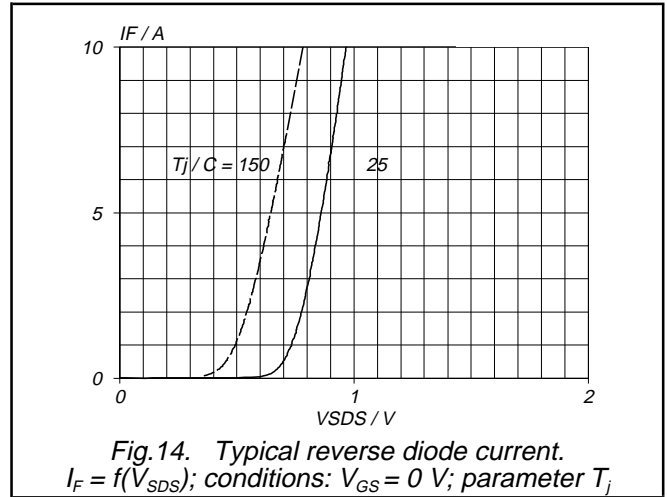
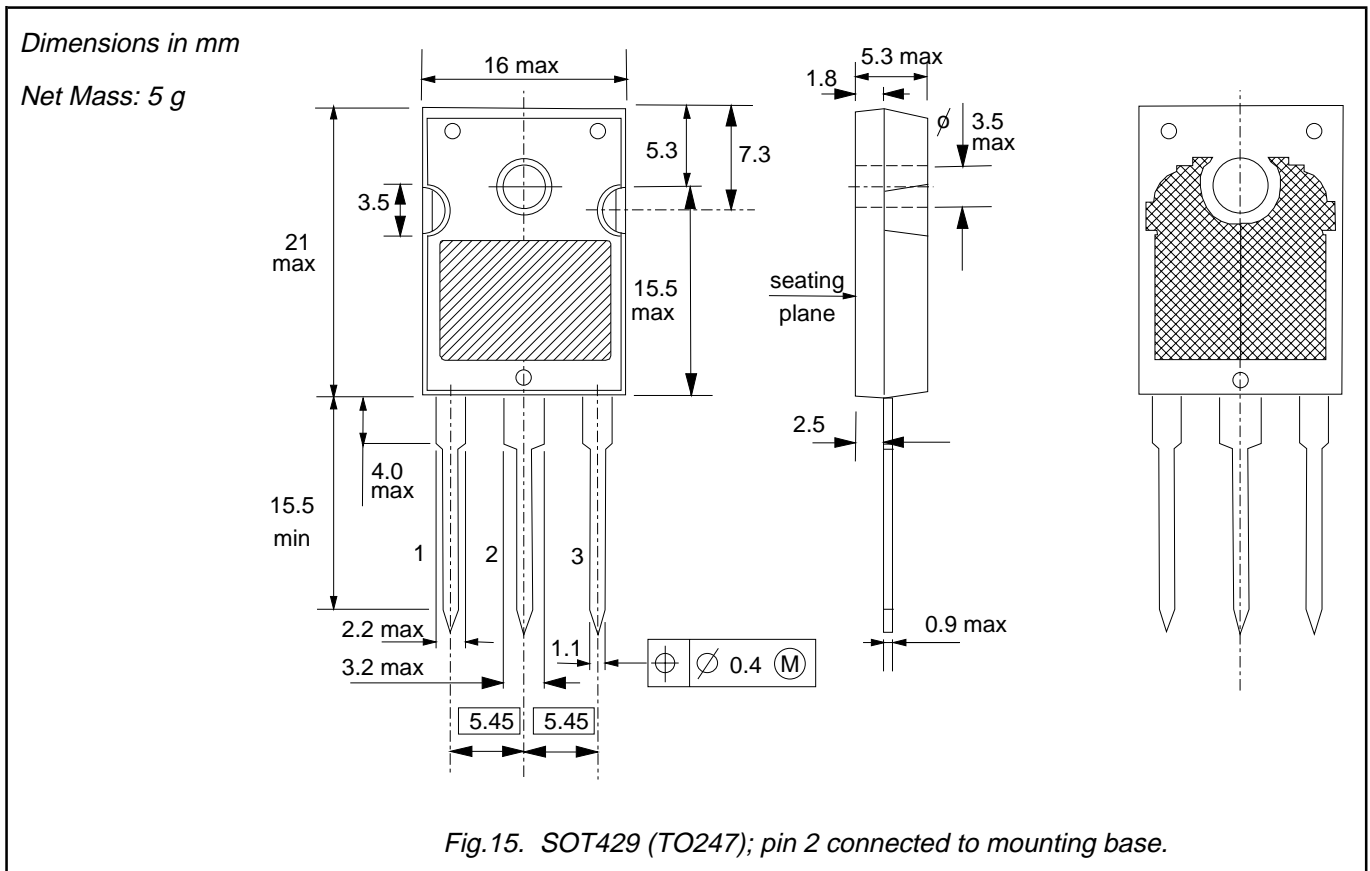

Fig.14. Typical reverse diode current.
 $I_F = f(V_{SDS})$; conditions: $V_{GS} = 0$ V; parameter T_j

PowerMOS transistor

BUK436W-800A/B

MECHANICAL DATA



Notes

1. Observe the general handling precautions for electrostatic-discharge sensitive devices (ESDs) to prevent damage to MOS gate oxide.
2. Refer to mounting instructions for SOT429 envelopes.
3. Epoxy meets UL94 V0 at 1/8".

PowerMOS transistor

BUK436W-800A/B

DEFINITIONS

Data sheet status	
Objective specification	This data sheet contains target or goal specifications for product development.
Preliminary specification	This data sheet contains preliminary data; supplementary data may be published later.
Product specification	This data sheet contains final product specifications.
Limiting values	
Limiting values are given in accordance with the Absolute Maximum Rating System (IEC 134). Stress above one or more of the limiting values may cause permanent damage to the device. These are stress ratings only and operation of the device at these or at any other conditions above those given in the Characteristics sections of this specification is not implied. Exposure to limiting values for extended periods may affect device reliability.	
Application information	
Where application information is given, it is advisory and does not form part of the specification.	
© Philips Electronics N.V. 1998	
All rights are reserved. Reproduction in whole or in part is prohibited without the prior written consent of the copyright owner.	
The information presented in this document does not form part of any quotation or contract, it is believed to be accurate and reliable and may be changed without notice. No liability will be accepted by the publisher for any consequence of its use. Publication thereof does not convey nor imply any license under patent or other industrial or intellectual property rights.	

LIFE SUPPORT APPLICATIONS

These products are not designed for use in life support appliances, devices or systems where malfunction of these products can be reasonably expected to result in personal injury. Philips customers using or selling these products for use in such applications do so at their own risk and agree to fully indemnify Philips for any damages resulting from such improper use or sale.