

SIEMENS AKTIENGESELLSCHAFT

Main ratings

Drain-source voltage  $V_{DS} = 100\text{ V}$   
 Continuous drain current  $I_D = 10\text{ A}$   
 Drain-source on-resistance  $R_{DS(on)} = 0,2\ \Omega$

N-Channel

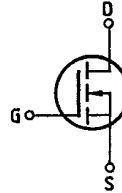

Description SIPMOS, N-channel, enhancement mode  
 Case Metal case 3A2 in accordance with DIN 41872, or TO 204 AA (TO 3) in accordance with JEDEC.  
 Approx. weight 12 g

Type	Ordering code
BUZ 23	C67078-A1002-A2

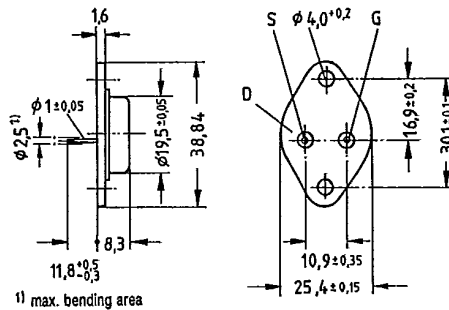

Dimensions in mm

Maximum ratings

Description	Symbols	Ratings	Units	Conditions
Drain-source voltage	$V_{DS}$	100	V	
Drain-gate voltage	$V_{DGR}$	100	V	$R_{GS} = 20\text{ k}\Omega$
Continuous drain current	$I_D$	10	A	$T_C = 85\text{ }^\circ\text{C}$
Pulsed drain current	$I_{D,puls}$	40	A	$T_C = 25\text{ }^\circ\text{C}$
Gate-source voltage	$V_{GS}$	$\pm 20$	V	
Max. power dissipation	$P_D$	78	W	$T_C = 25\text{ }^\circ\text{C}$
Operating and storage temperature range	$T_j$ $T_{stg}$	$-55 \dots +150$	$^\circ\text{C}$	
DIN humidity category	C			DIN 40040
IEC climatic category		55/150/56		DIN IEC 68-1

Thermal resistance

Chip - case	$R_{th,JC}$	$\leq 1,6$	K/W
Chip - ambient	$R_{th,JA}$	$\leq 35$	K/W

220 Preferred Type

0802 A-13

## SIEMENS AKTIENGESELLSCHAFT

**Electrical characteristics**(at  $T_j = 25^\circ\text{C}$  unless otherwise specified)

Description	Symbol	Characteristics			Unit	Conditions
		min.	typ.	max.		

**Static ratings**

Drain-source breakdown voltage	$V_{(BR)DSS}$	100	—	—	V	$V_{GS} = 0V$ $I_D = 0,25mA$
Gate threshold voltage	$V_{GS(th)}$	2,1	3,0	4,0		$V_{DS} = V_{GS}$ $I_D = 1mA$
Zero gate voltage drain current	$I_{DSS}$	—	20	250	$\mu A$	$T_j = 25^\circ C$ $T_j = 125^\circ C$ $V_{DS} = 100V$ $V_{GS} = 0V$
Gate-source leakage current	$I_{GSS}$	—	10	100	nA	$V_{GS} = 20V$ $V_{DS} = 0V$
Drain-source on-resistance	$R_{DS(on)}$	—	0,15	0,2	$\Omega$	$V_{GS} = 10V$ $I_D = 6A$

**Dynamic ratings**

Forward transconductance	$g_{fs}$	2,7	4,0	—	S	$V_{DS} = 25V$ $I_D = 6A$
Input capacitance	$C_{iss}$	—	1500	2000	pF	$V_{GS} = 0V$ $V_{DS} = 25V$ $f = 1MHz$
Output capacitance	$C_{oss}$	—	300	500		
Reverse transfer capacitance	$C_{rss}$	—	80	140		
Turn-on time $t_{on}$ ( $t_{on} = t_{d(on)} + t_r$ )	$t_{d(on)}$	—	30	45	ns	$V_{CC} = 30V$ $I_D = 2,9A$ $V_{GS} = 10V$ $R_{GS} = 50\Omega$
	$t_r$	—	50	75		
Turn-off time $t_{off}$ ( $t_{off} = t_{d(off)} + t_f$ )	$t_{d(off)}$	—	110	140	ns	
	$t_f$	—	60	80		

**Reverse diode**

Continuous reverse drain current	$I_{DR}$	—	—	10	A	$T_C = 25^\circ C$
Pulsed reverse drain current	$I_{DRM}$	—	—	40		
Diode forward on-voltage	$V_{SD}$	—	1,3	1,6	V	$I_F = 2 \times I_{DR}$ $V_{GS} = 0V, T_j = 25^\circ C$
Reverse recovery time	$t_{rr}$	—	200	—	ns	$T_j = 25^\circ C$
Reverse recovery charge	$Q_{rr}$	—	1,6	—	$\mu C$	$I_F = I_{DR}$ $d_{F/dt} = 100A/\mu s$ $V_R = 30V$

SIEMENS AKTIENGESELLSCHAFT

Power dissipation  $P_D = f(T_C)$

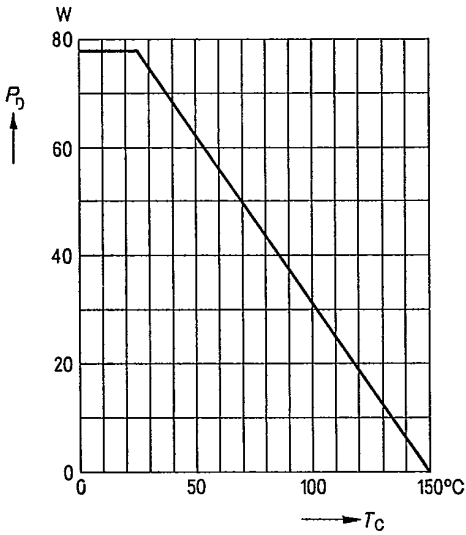

Typical output characteristics  $I_D = f(V_{DS})$   
 parameter: 80  $\mu$ s pulse test,  
 $T_I = 25^\circ\text{C}$

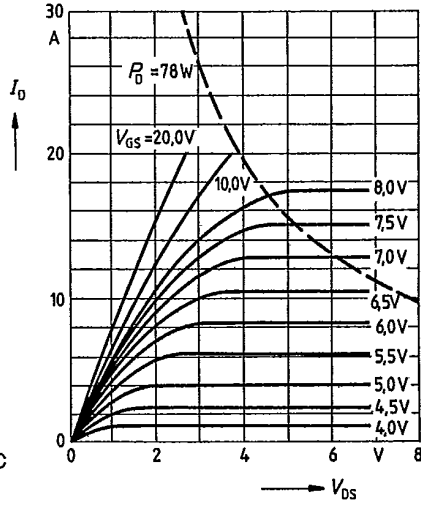

Safe operating area  $I_D = f(V_{DS})$   
 parameter:  $D = 0.01$ ,  $T_C = 25^\circ\text{C}$

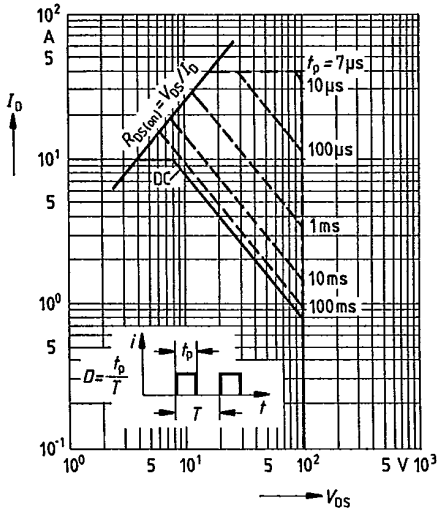

Typical transfer characteristic  $I_D = f(V_{GS})$   
 parameter: 80  $\mu$ s pulse test,  
 $V_{DS} = 25\text{V}$ ,  $T_I = 25^\circ\text{C}$

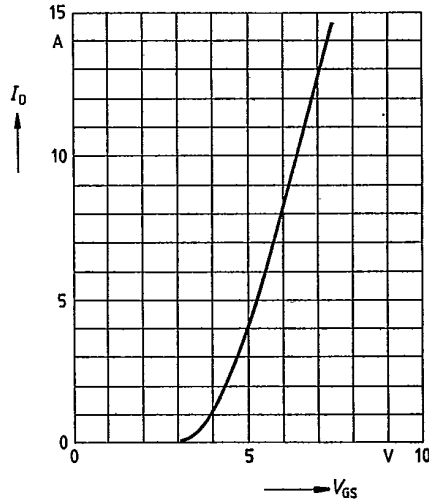

SIEMENS AKTIENGESELLSCHAFT

Typical drain-source on-state resistance

$R_{DS(on)} = f(I_D)$   
parameter:  $V_{GS} = 10V, T_j = 25^\circ C$

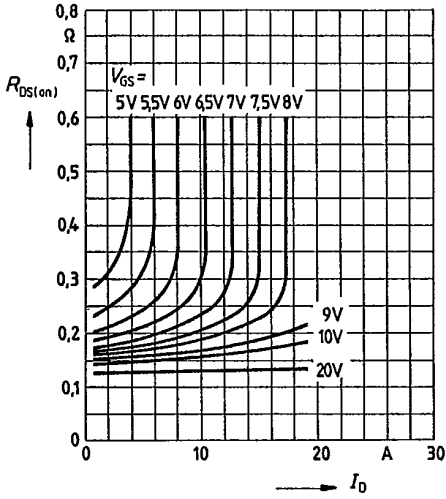

Drain-source on-state resistance

$R_{DS(on)} = f(T_j)$   
parameter:  $I_D = 6A, V_{GS} = 10V$   
(spread)

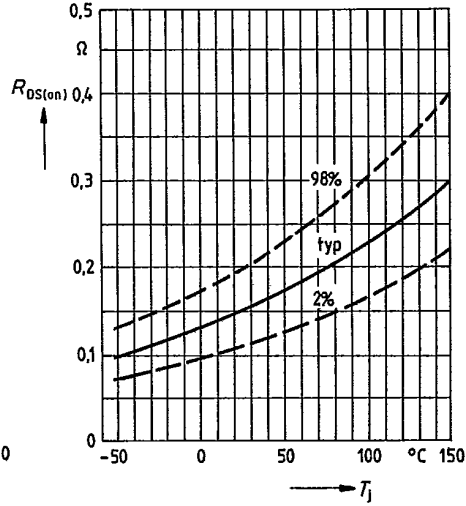

Typical transconductance  $g_{fs} = f(I_D)$

parameter: 80  $\mu s$  pulse test,  
 $V_{DS} = 25V, T_j = 25^\circ C$

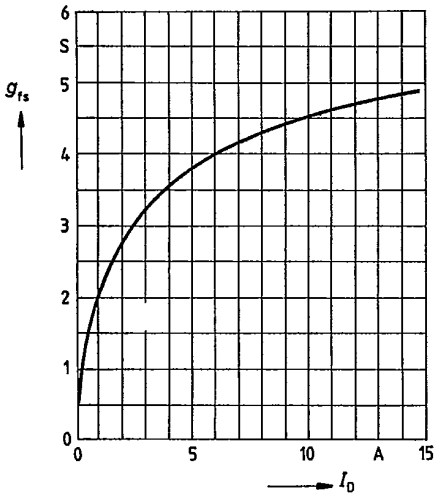

Gate threshold voltage  $V_{GS(th)} = f(T_j)$

parameter:  $V_{DS} = V_{GS}, I_D = 1mA$   
(spread)

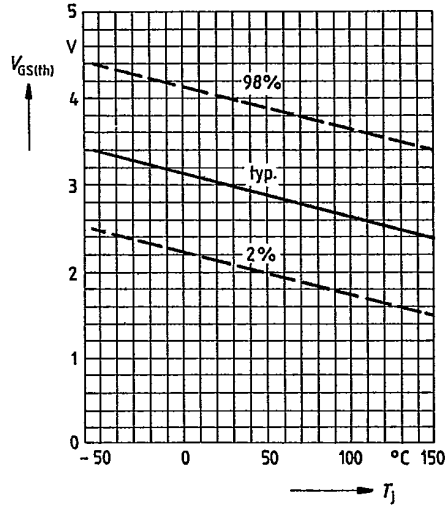

SIEMENS AKTIENGESELLSCHAFT

Typical capacitances  $C = f(V_{GS})$   
 parameter:  $V_{GS} = 0, f = 1\text{MHz}$

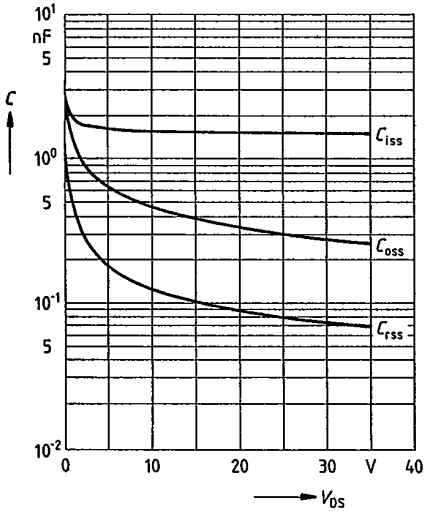

Continuous drain current  $I_D = f(T_C)$   
 parameter:  $V_{GS} \geq 10\text{V}$

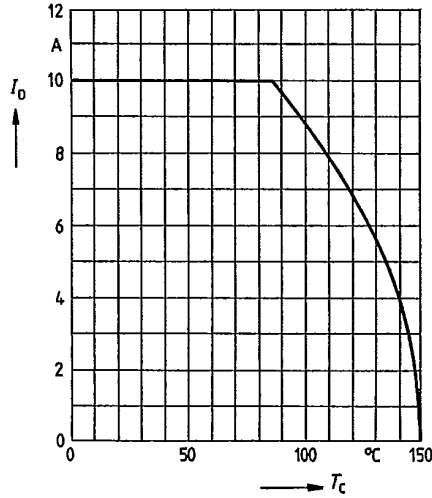

Forward characteristic of reverse diode

$I_F = f(V_{SD})$   
 parameter:  $T_j, t_p = 80 \mu\text{s}$   
 (spread)

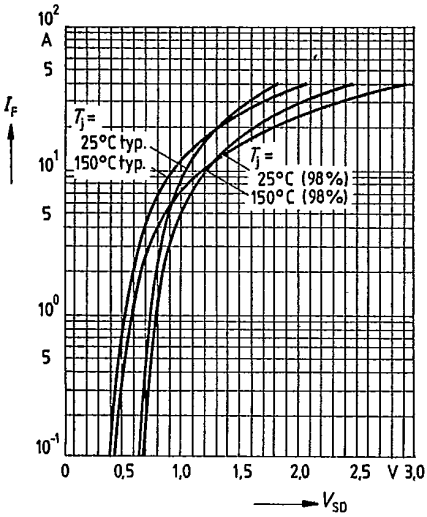

SIEMENS AKTIENGESELLSCHAFT

Transient thermal impedance  $Z_{thJC} = f(t)$   
 parameter:  $D = t_p/T$

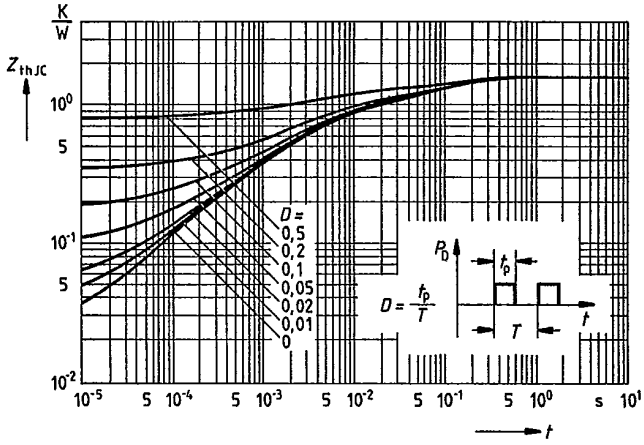

Typical gate-charge  $V_{GS} = f(Q_{Gate})$   
 parameter:  $I_{D\ puls} = 18A$

