

DATA SHEET

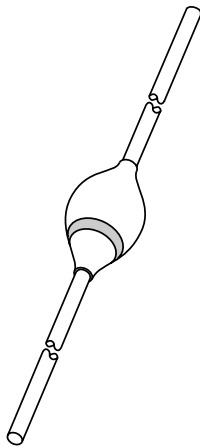

BYX90G

High-voltage soft-recovery
controlled avalanche rectifier

Product specification
Supersedes data of June 1996

1996 Sep 26

High-voltage soft-recovery controlled avalanche rectifier

BYX90G

FEATURES

- Glass passivated
- High maximum operating temperature
- Low leakage current
- Excellent stability
- Soft-recovery switching characteristics
- Guaranteed avalanche energy absorption capability.

APPLICATIONS

- High-voltage rectification at high frequencies
- Sub-component for very high voltage rectifiers, for example, in X-ray and radar equipment.

DESCRIPTION

Rugged glass package, using a high temperature alloyed construction.

This package is hermetically sealed and fatigue free as coefficients of expansion of all used parts are matched.

The package is designed to be used in an insulating medium such as resin, oil or SF6 gas.

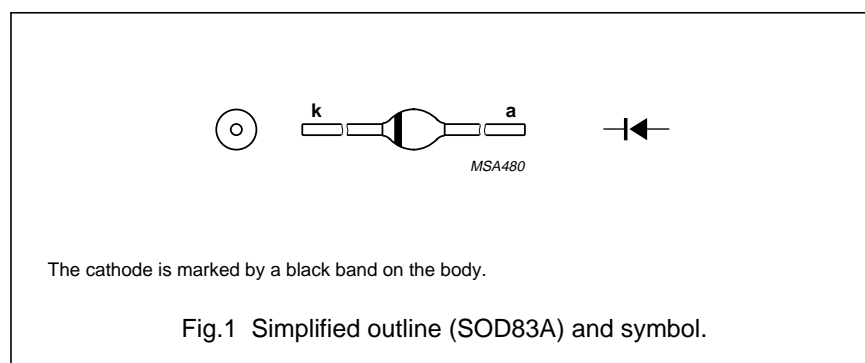

LIMITING VALUES

In accordance with the Absolute Maximum Rating System (IEC 134).

SYMBOL	PARAMETER	CONDITIONS	MIN.	MAX.	UNIT
V_{RRM}	repetitive peak reverse voltage		–	7.5	kV
V_{RWM}	crest working reverse voltage		–	6	kV
$I_{F(AV)}$	average forward current	averaged over any 20 ms period; $T_{oil} = 45\text{ °C}$; see Fig.2; see also Fig.3	–	550	mA
I_{FRM}	repetitive peak forward current		–	5	A
I_{FSM}	non-repetitive peak forward current	$t = 10\text{ ms}$ half sinewave; $T_j = T_{j\text{ max}}$ prior to surge; $V_R = V_{RWM\text{ max}}$; see Fig.4	–	20	A
P_{RSM}	non-repetitive peak reverse power dissipation	$t = 10\text{ }\mu\text{s}$; triangular pulse; $T_j = T_{j\text{ max}}$ prior to surge	–	5	kW
T_{stg}	storage temperature		–65	+165	°C
T_j	junction temperature		–65	+165	°C

High-voltage soft-recovery controlled avalanche rectifier

BYX90G

ELECTRICAL CHARACTERISTICS $T_j = 25\text{ °C}$; unless otherwise specified.

SYMBOL	PARAMETER	CONDITIONS	MIN.	TYP.	MAX.	UNIT
V_F	forward voltage	$I_F = 2\text{ A}$; see Fig.5	–	–	14.5	V
$V_{(BR)R}$	reverse avalanche breakdown voltage	$I_R = 0.1\text{ mA}$	8	–	–	kV
I_R	reverse current	$V_R = V_{RWMmax}$; $T_j = T_{j\ max}$	–	–	50	μA
t_{rr}	reverse recovery time	when switched from $I_F = 0.5\text{ A}$ to $I_R = 1\text{ A}$; measured at $I_R = 0.25\text{ A}$; see Fig.7	–	–	350	ns

THERMAL CHARACTERISTICS

SYMBOL	PARAMETER	CONDITIONS	VALUE	UNIT
$R_{th\ j-o}$	thermal resistance from junction to oil	note 1; see also Fig.6	20	K/W

Note

- For more information please refer to the "General Part of associated Handbook".

High-voltage soft-recovery controlled avalanche rectifier

BYX90G

GRAPHICAL DATA

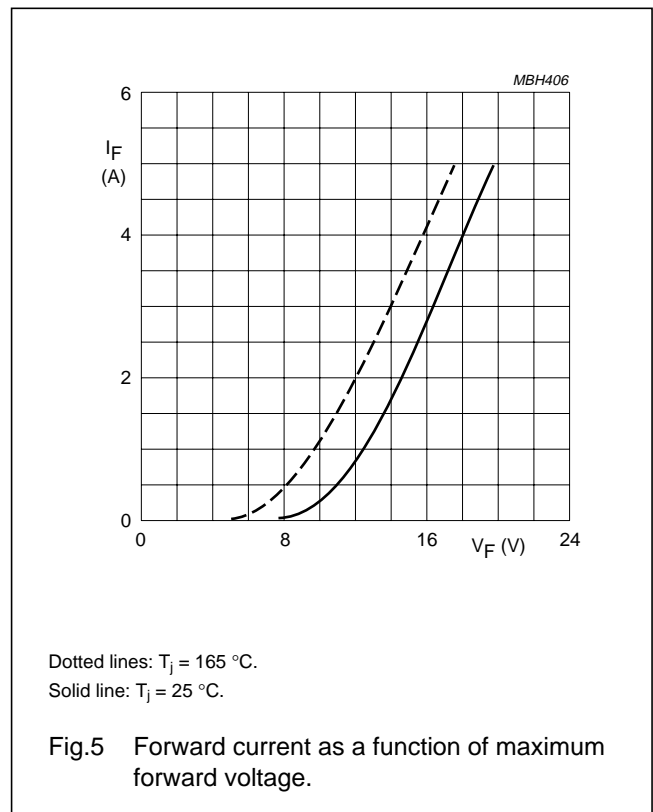
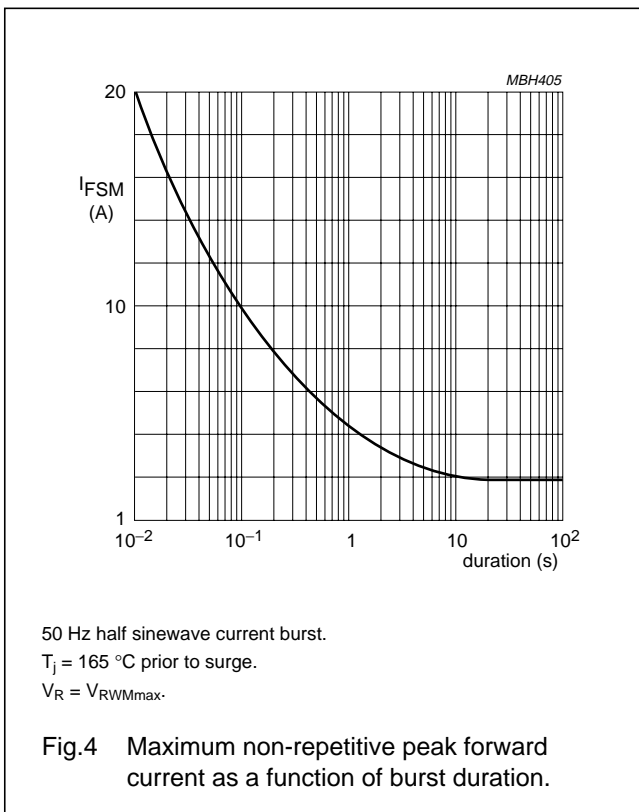
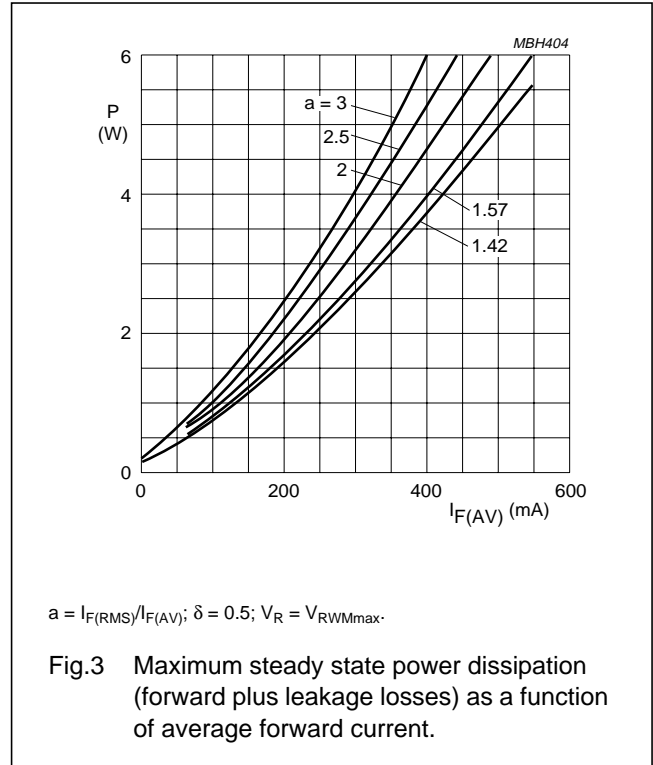
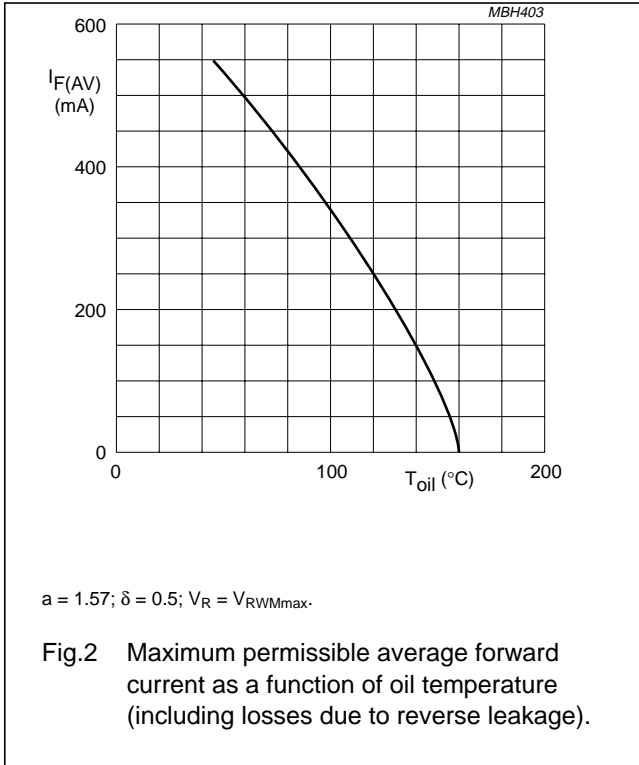

High-voltage soft-recovery controlled avalanche rectifier

BYX90G

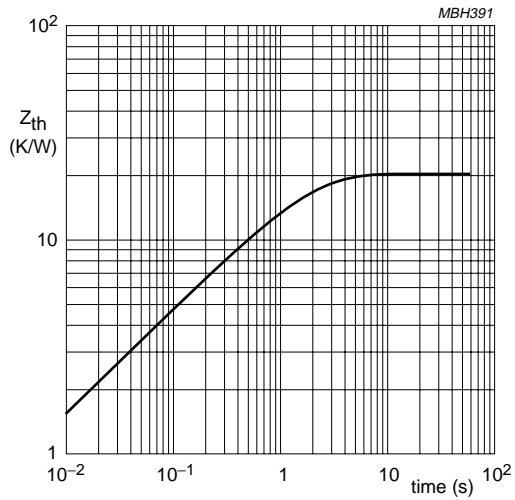
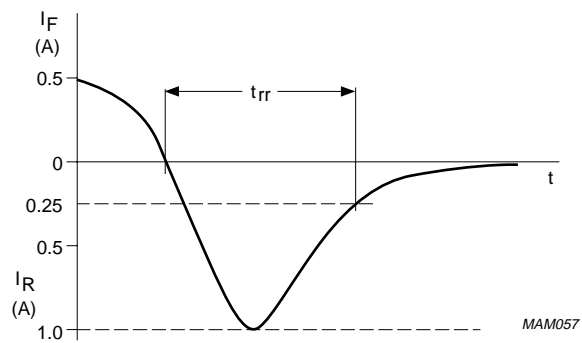
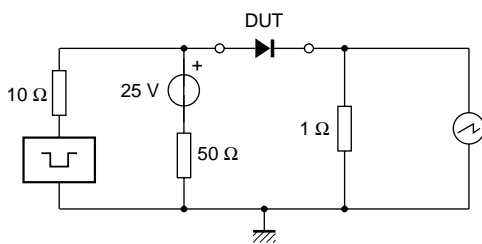

Fig.6 Thermal impedance in oil as a function of time.



Input impedance oscilloscope: 1 MΩ, 22 pF; $t_r \leq 7$ ns.
Source impedance: 50 Ω; $t_r \leq 15$ ns.

Fig.7 Test circuit and reverse recovery time waveform and definition.

High-voltage soft-recovery controlled avalanche rectifier

BYX90G

APPLICATION INFORMATION

Typical 3-phase bridge application information

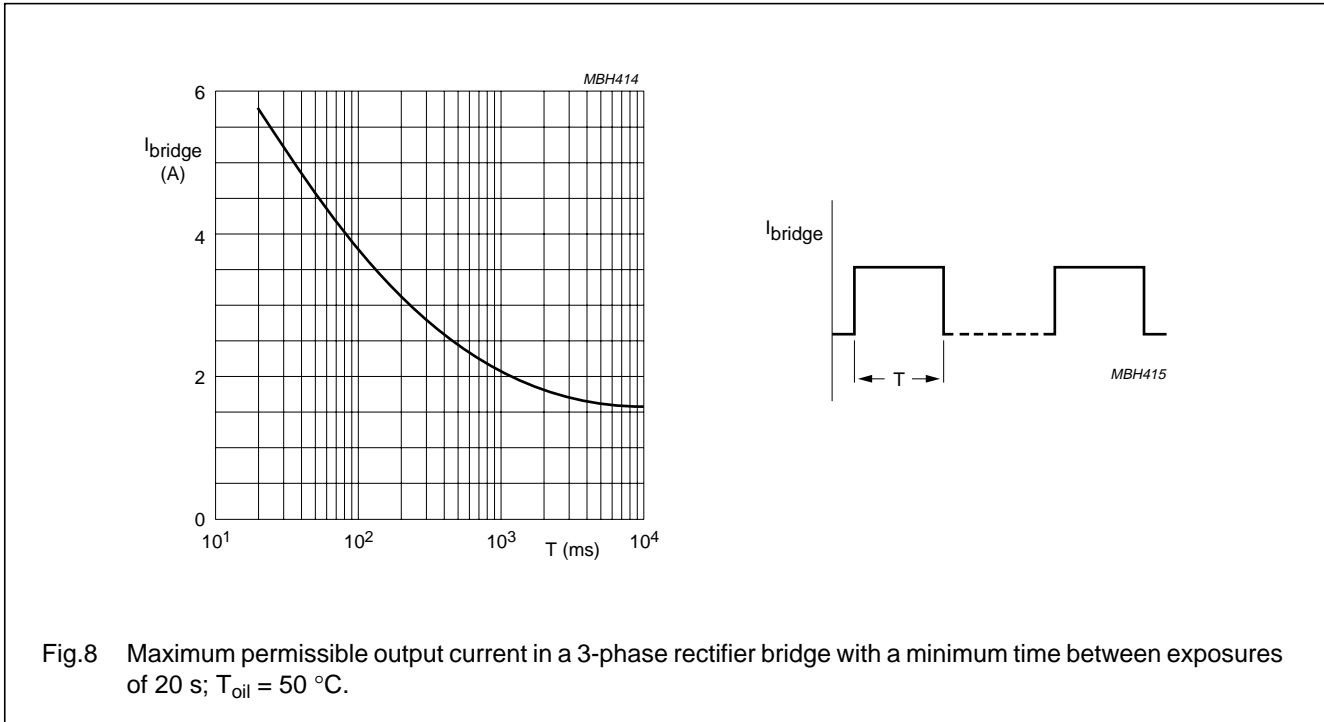

High-voltage soft-recovery
controlled avalanche rectifier

BYX90G

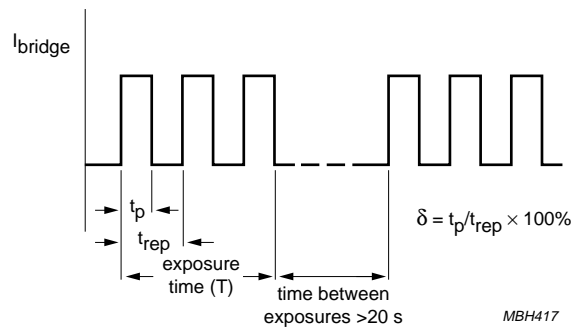
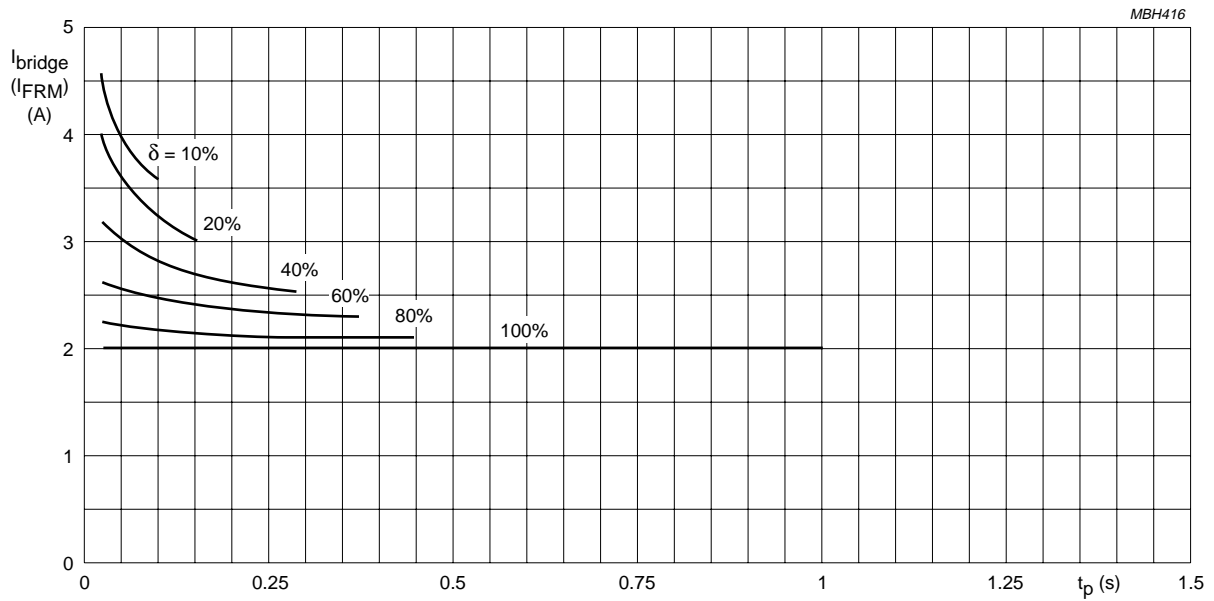

Fig.9 Maximum current through a 3-phase bridge rectifier versus pulse duration; exposure time $T = 1$ s;
 $T_{oil} = 50$ °C.

High-voltage soft-recovery
controlled avalanche rectifier

BYX90G

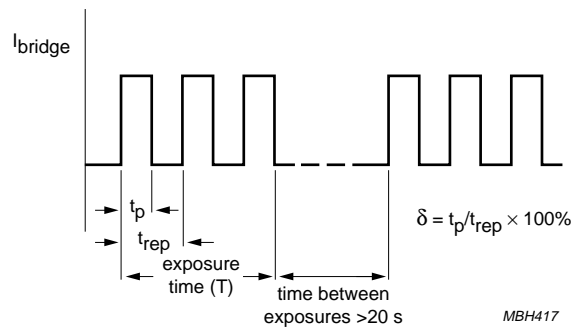
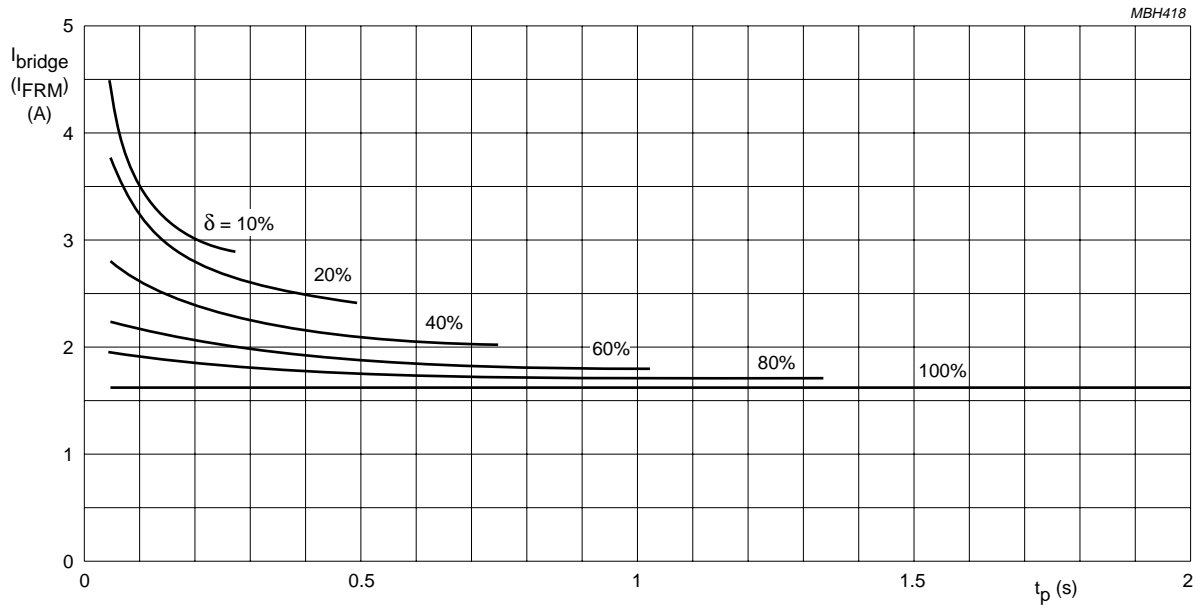
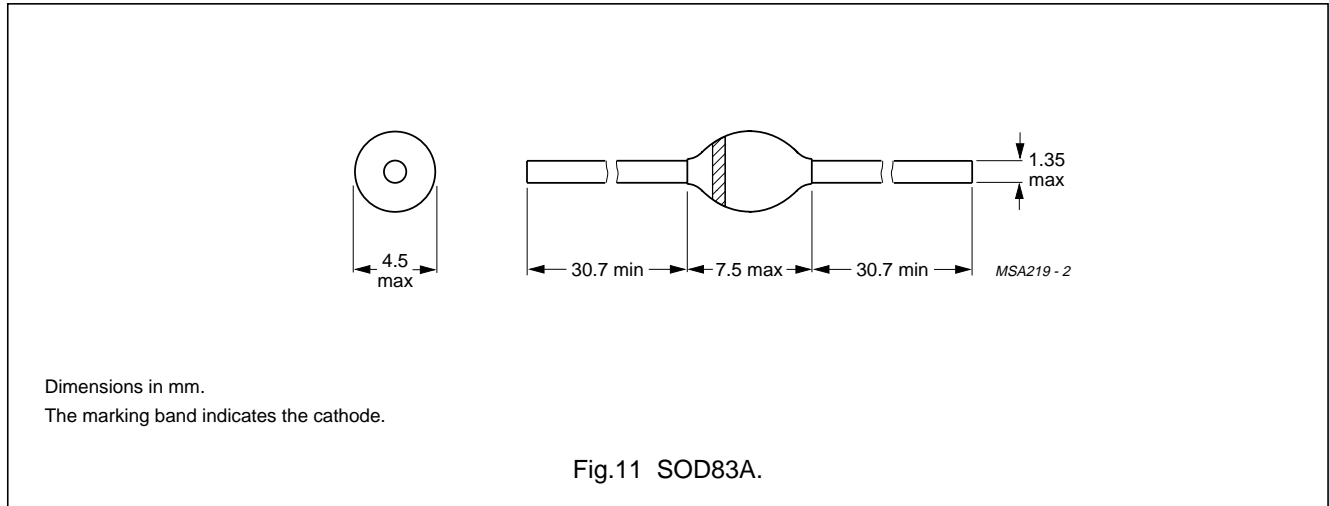

Fig.10 Maximum current through a 3-phase bridge rectifier versus pulse duration; exposure time $T = 3$ s;
 $T_{oil} = 50$ °C.

High-voltage soft-recovery
controlled avalanche rectifier

BYX90G

PACKAGE OUTLINE



DEFINITIONS

Data Sheet Status	
Objective specification	This data sheet contains target or goal specifications for product development.
Preliminary specification	This data sheet contains preliminary data; supplementary data may be published later.
Product specification	This data sheet contains final product specifications.
Limiting values	
Limiting values given are in accordance with the Absolute Maximum Rating System (IEC 134). Stress above one or more of the limiting values may cause permanent damage to the device. These are stress ratings only and operation of the device at these or at any other conditions above those given in the Characteristics sections of the specification is not implied. Exposure to limiting values for extended periods may affect device reliability.	
Application information	
Where application information is given, it is advisory and does not form part of the specification.	

LIFE SUPPORT APPLICATIONS

These products are not designed for use in life support appliances, devices, or systems where malfunction of these products can reasonably be expected to result in personal injury. Philips customers using or selling these products for use in such applications do so at their own risk and agree to fully indemnify Philips for any damages resulting from such improper use or sale.