



Micro Commercial Components
21201 Itasca Street Chatsworth
CA 91311
Phone: (818) 701-4933
Fax: (818) 701-4939

BZT52C2V4 THRU BZT52C39

Features

- Planar Die construction
- 410mW Power Dissipation
- Zener Voltages from 2.4V - 39V
- Ideally Suited for Automated Assembly Processes

Mechanical Data

- Case: SOD-123 Molded Plastic
- Terminals: Solderable per MIL-STD-202, Method 208
- Approx. Weight: 0.008 gram
- Mounting Position: Any
- Storage & Operating Junction Temperature: -55°C to $+150^{\circ}\text{C}$

Maximum Ratings @ 25°C Unless Otherwise Specified

Zener Current	I_F	100	mA
Maximum Forward Voltage	V_F	1.2	V
Power Dissipation (Notes A)	$P_{(AV)}$	410	mWatt
Peak Forward Surge Current (Notes B)	I_{FSM}	2.0	Amps

NOTES:

- A. Mounted on 5.0mm² (.013mm thick) land areas.
B. Measured on 8.3ms, single half sine-wave or equivalent square wave, duty cycle = 4 pulses per minute maximum.

410 mW

Zener Diodes

2.4 to 39 Volts

SOD123

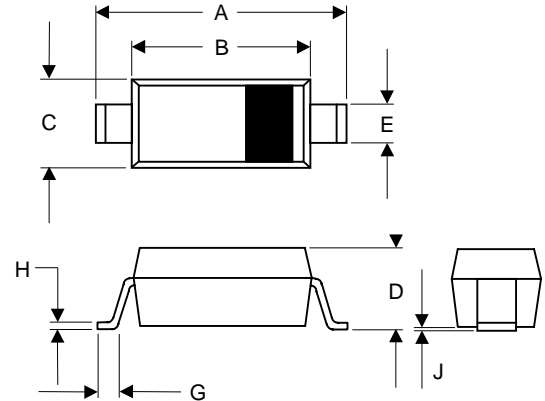

DIM	DIMENSIONS				NOTE
	INCHES		MM		
A	.140	.152	3.55	3.85	
B	.100	.112	2.55	2.85	
C	.055	.071	1.40	1.80	
D	-----	.053	-----	1.35	
E	.012	.031	0.30	.78	
G	.006	-----	0.15	-----	
H	-----	.01	-----	.25	
J	-----	.006	-----	.15	

SUGGESTED SOLDER PAD LAYOUT

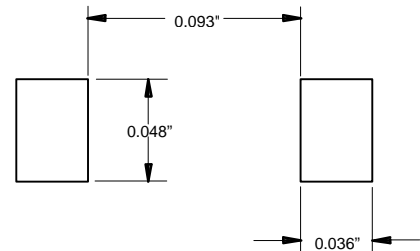

BZT52C2V4 thru BZT52C39

Electrical Characteristics @ 25°C Unless Otherwise Specified

MCC PART NUMBER	Marking	NORMAL ZENER VOLTAGE Vz @ Izt	TEST CURRENT Izt	MAXIMUM ZENER IMPEDANCE 'B' SUFFIX ONLY Zzt @ Izt Zzk @ Izk=1.0mA		MAXIMUM REVERSE LEAKAGE CURRENT Ir @ Vr		Max. Zener Current Izm @ TA
				OHMS	OHMS	nA	VOLTS	
BZT52C2V4	W1	2.4	5	85	600	100000	1.0	-
BZT52C2V7	W2	2.7	5	83	500	75000	1.0	134
BZT52C3	W3	3.0	5	95	500	50000	1.0	118
BZT52C3V3	W4	3.3	5	95	500	25000	1.0	109
BZT52C3V6	W5	3.6	5	95	500	15000	1.0	100
BZT52C3V9	W6	3.9	5	95	500	10000	1.0	92
BZT52C4V3	W7	4.3	5	95	500	5000	1.0	84
BZT52C4V7	W8	4.7	5	78	500	5000	1.0	76
BZT52C5V1	W9	5.1	5	60	480	100	0.8	67
BZT52C5V6	WA	5.6	5	40	400	100	1.0	59
BZT52C6V2	WB	6.2	5	10	200	100	2.0	54
BZT52C6V8	WC	6.8	5	8.0	150	100	3.0	49
BZT52C7V5	WD	7.5	5	7.0	50	100	5.0	44
BZT52C8V2	WE	8.2	5	7.0	50	100	6.0	40
BZT52C9V1	WF	9.1	5	10	50	100	7.0	36
BZT52C10	WG	10	5	15	70	100	7.5	33
BZT52C11	WH	11	5	20	70	100	8.5	30
BZT52C12	WI	12	5	20	90	100	9.0	28
BZT52C13	WK	13	5	25	110	100	10	25
BZT52C15	WL	15	5	30	110	100	11	23
BZT52C16	WM	16	5	40	170	100	12	20
BZT52C18	WN	18	5	50	170	100	14	18
BZT52C20	WO	20	5	50	220	100	15	17
BZT52C22	WP	22	5	55	220	100	17	16
BZT52C24	WR	24	5	80	220	100	18	13
BZT52C27	WS	27	5	80	250	100	20	12
BZT52C30	WT	30	5	80	250	100	22.5	10
BZT52C33	WU	33	5	80	250	100	25	9
BZT52C36	WW	36	5	90	250	100	27	9
BZT52C39	WX	39	5	90	300	100	29	8

NOTE:

1. Tolerance and Type Number Designation. The type numbers listed have a standard tolerance on the nominal zener voltage of $\pm 5\%$.
2. Specials Available Include:
 - A. Nominal zener voltages between the voltages shown and tighter voltage tolerances.
 - B. Matched sets.
3. Zener Voltage (Vz) Measurement. Guarantees the zener voltage when measured at 90 seconds while maintaining the lead temperature (TL) at 30°C, from the diode body.
4. Zener Impedance (Zz) Derivation. The zener impedance is derived from the 60 cycle ac voltage, which results when an AC current having an rms value equal to 10% of the dc zener current (Izt or Izk) is superimposed on Izt or Izk.
5. Surge Current (Ir) Non-Repetitive. The rating listed in the electrical characteristics table is maximum peak, non-repetitive, reverse surge current of 1/2 square wave or equivalent sine wave pulse of 1/120 second duration superimposed on the test current, Izt, per JEDEC registration; however, actual device capability is as described in Figure 5.

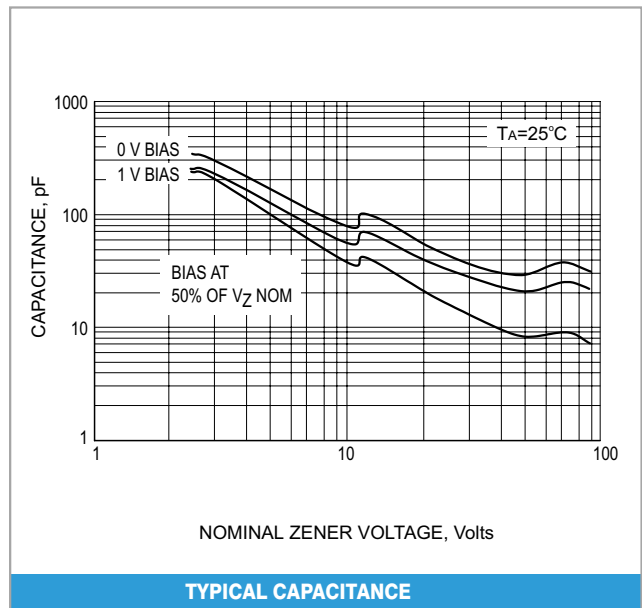
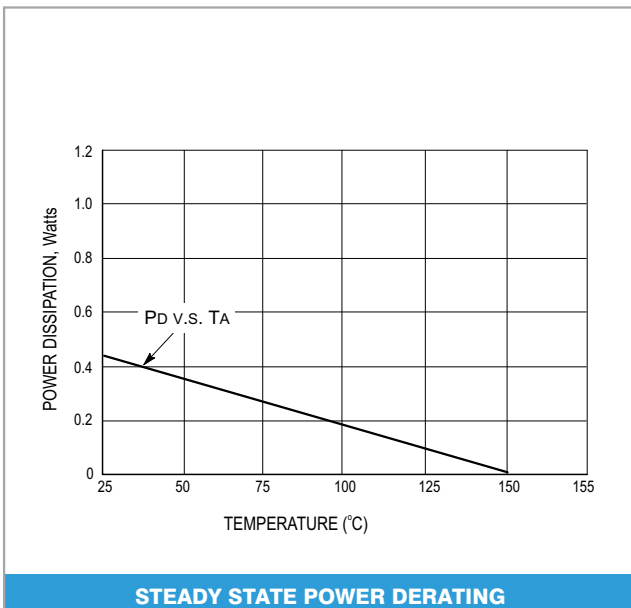
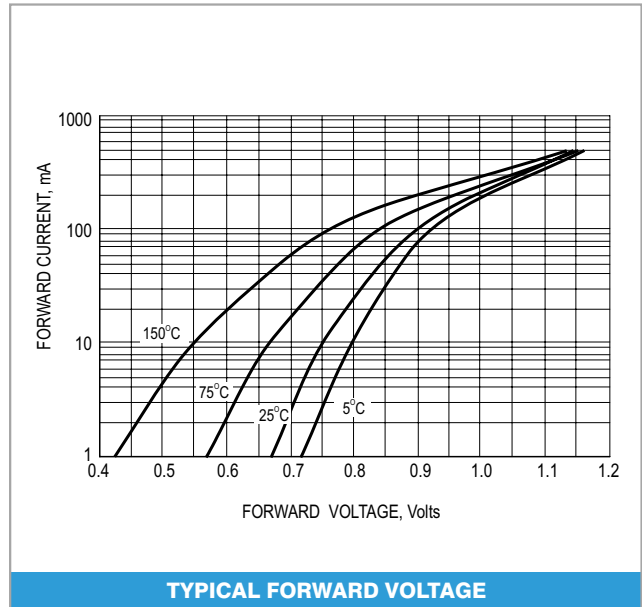
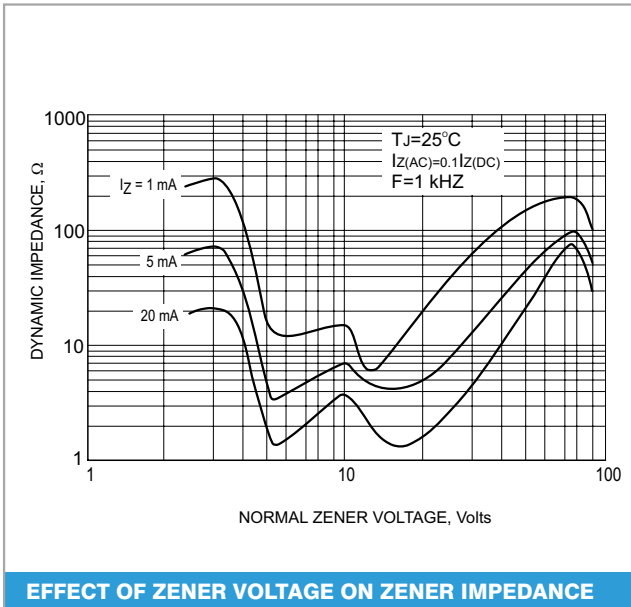
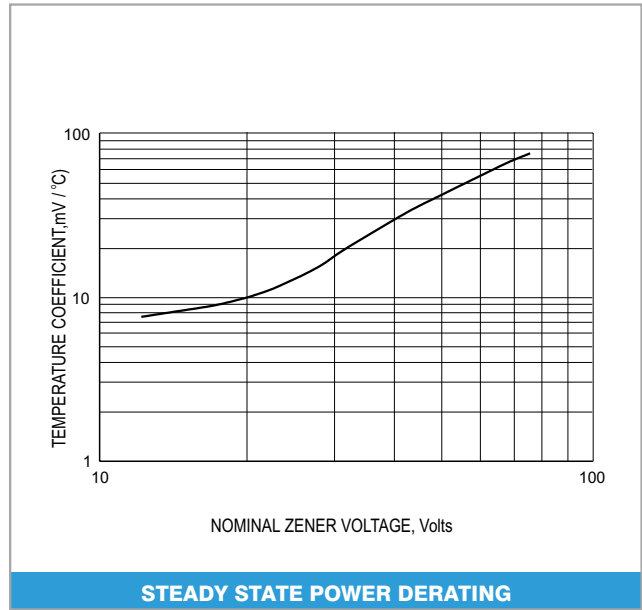
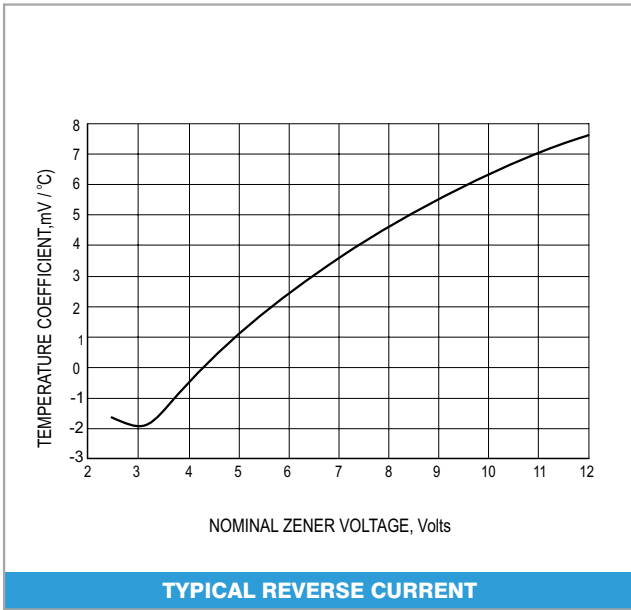

BZT52C2V4 thru BZT52C39

