



T-25-19

C380__X500

Powerex, Inc. Hillis Street, Youngwood, Pennsylvania 15697 (412) 925-7272
 Powerex Europe, S.A., 428 Ave. G. Durand, BP107, 72003 LeMans, France (43) 72.75.15

Phase Control SCR
310 Amperes Avg
800 Volts

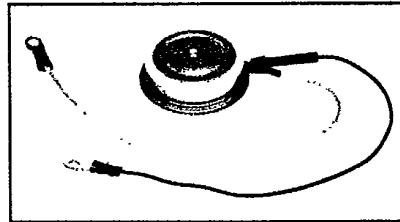
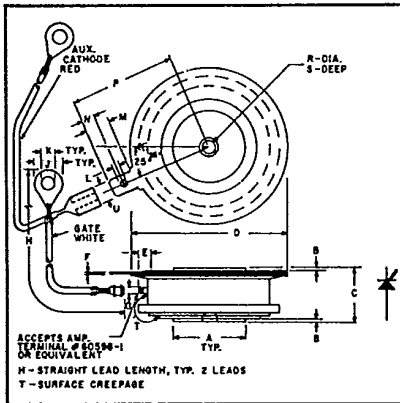

C380__X500
Phase Control SCR
 310 Amperes/800 Volts

Description

Powerex Silicon Controlled Rectifiers (SCR) are designed for phase control applications. These are all-diffused, Press-Pak (Pow-R-Disc) devices employing the field-proven amplifying (di/namic) gate.

Features:

- Low On-State Voltage
- High di/dt
- High dv/dt
- Hermetic Packaging
- Excellent Surge and I²t Ratings

Applications:

- Power Supplies
- Battery Chargers
- Motor Control
- Light Dimmers
- VAR Generators

Ordering Information

Example: Select the complete nine digit part number you desire from the table - i.e. C380MX500 is a 600 Volt, 310 Ampere Phase Control SCR.

C380__X500
Outline Drawing

Dimensions	Inches		Millimeters	
	Min.	Max.	Min.	Max.
A	.744	.752	18.897	19.101
B	.030	.060	.762	1.524
C	.515	.565	13.081	14.351
D	1.600	1.656	40.64	42.06
E	.110	—	2.794	—
F	.013	.017	.330	.432
G	.057	.059	1.447	1.449
H	7.980	8.115	202.70	206.11
J	—	.300	—	7.620
K	.137	.153	3.479	3.886
L	.065	.070	1.651	1.778
M	.245	.260	6.223	6.604
N	.120	.140	3.048	3.556
P	1.090	1.125	27.69	28.55
R	.135	.145	3.429	3.683
S	.067	.083	1.701	2.108
T	.340	—	8.636	—
U	.186	.189	4.724	4.801

Type	Voltage		Current
	V _{ORM} V _{RRM}	Code	
C380__X500	100	A	310
	200	B	
	300	C	
	400	D	
	500	E	
	600	M	
	700	S	
	800	N	



Powerex, Inc., Hillis Street, Youngwood, Pennsylvania 15697 (412) 925-7272
 Powerex Europe, S.A., 428 Ave. G. Durand, BP107, 72003 LeMans, France (43) 72.75.15

C380_X500
 Phase Control SCR
 310 Amperes Avg/800 Volts

Absolute Maximum Ratings

	Symbol	C380_X500	Units
RMS On-State Current	$I_{T(RMS)}$	500	Amperes
Average On-State Current	$I_{T(av)}$	310	Amperes
Peak One-Cycle Surge (Non-Repetitive) On-State Current (60Hz)	I_{TSM}	5500	Amperes
Peak One-Cycle Surge (Non-Repetitive) On-State Current (50Hz)	I_{TSM}	5000	Amperes
Critical Rate-of-Rise of On-State Current (Non-Repetitive)	di/dt	800	Amperes/ μ s
Critical Rate-of-Rise of On-State Current (Repetitive)	di/dt	500	Amperes/ μ s
I^2t (for Fusing), One Cycle at 60Hz	I^2t	125,000	A ² sec
Peak Gate Power Dissipation	P_{GM}	10	Watts
Average Gate Power Dissipation	$P_{G(av)}$	2	Watts
Storage Temperature	T_{STG}	-40 to 150	°C
Operating Temperature	T_J	-40 to 125	°C
Mounting Force [Ⓞ]		720 to 880	lb.
Mounting Force [Ⓞ]		3.2 to 3.92	kN

Electrical and Thermal Characteristics

Characteristics	Symbol	Test Conditions	C380_X500	Units
Voltage—Blocking State Maximums				
Forward Leakage, Peak	I_{DRM}	$T_J = 125^\circ\text{C}, V = V_{DRM}$	20	mA
Reverse Leakage, Peak	I_{RRM}	$T_J = 125^\circ\text{C}, V = V_{RRM}$	20	mA
Current—Conducting State Maximums				
Peak On-State Voltage	V_{TM}	$T_C = 125^\circ\text{C}, I_{TM} = 1500\text{A}, \text{Duty Cycle} = 0.01\%$	1.75	Volts
Switching				
Typical Turn-On Delay	t_d	$T_C = 25^\circ\text{C}, I_T = 100\text{A}, V_{DRM} = \text{rated.}$ Gate Supply 10V Open Circuit, 25 Ω , 0.1 μ sec max. rise time	1	μ sec
Min. Critical dv/dt exponential to V_{DRM}	dv/dt	$T_J = 125^\circ\text{C}, \text{Gate open circuited.}$	200	V/ μ sec
Thermal				
Maximum Thermal Resistance, [Ⓞ] double sided cooling				
Junction to Case	$R_{\theta JC}$		0.095	°C/Watt
Case to Sink, Lubricated	$R_{\theta CS}$.02	°C/Watt
Gate—Maximum Parameters				
Gate Current to Trigger	I_{GT}	$T_C = 25^\circ\text{C}, V_D = 6\text{V}, R_L = 3 \Omega$	150	mA
Gate Voltage to Trigger	V_{GT}	$T_C = -40^\circ\text{C} \text{ to } 125^\circ\text{C}, V_D = 6\text{V}, R_L = 3 \Omega$	3.0	Volts
Non-Triggering Gate Voltage	V_{GDM}	$T_J = 125^\circ\text{C}, \text{Rated } V_{DRM}, R_L = 1000 \Omega$.15	Volts
Peak Forward Gate Current	I_{GTM}		10	Amperes
Peak Reverse Gate Voltage	V_{GRM}		5	Volts

[Ⓞ] Consult recommended mounting procedures.



Powerex, Inc., Hillis Street, Youngwood, Pennsylvania 15697 (412) 925-7272
 Powerex Europe, S.A., 428 Ave. G. Durand, BP107, 72003 LeMans, France (43) 72.75.15

C380_X500
 Phase Control SCR
 310 Amperes Avg/800 Volts

MAXIMUM ON-STATE CHARACTERISTICS

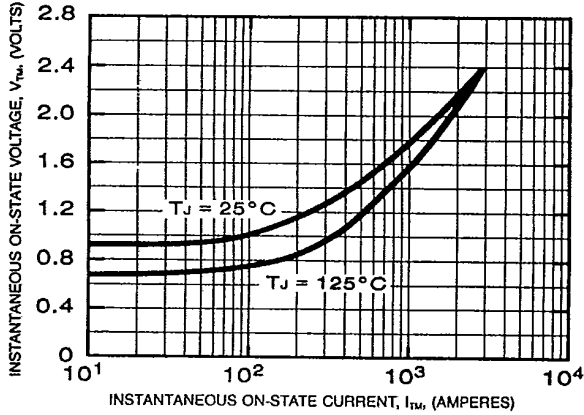

TRANSIENT THERMAL IMPEDANCE CHARACTERISTICS (JUNCTION TO CASE)

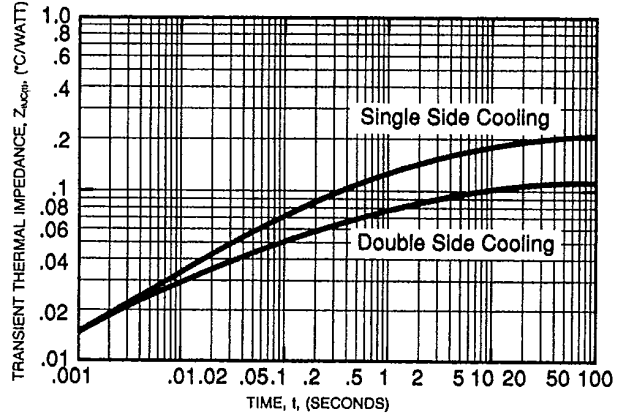

MAXIMUM ALLOWABLE CASE TEMPERATURE (SINUSOIDAL WAVEFORM)

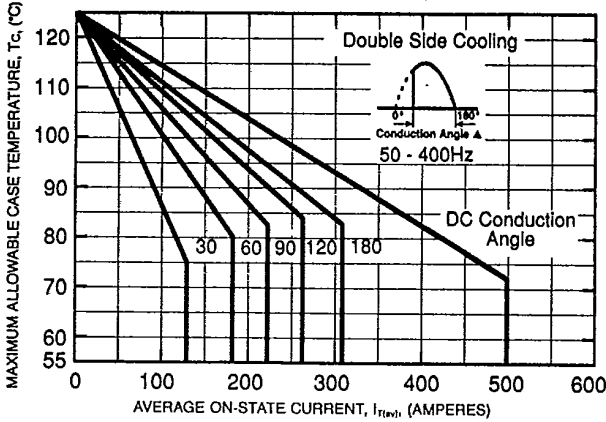

MAXIMUM ON-STATE POWER DISSIPATION (SINUSOIDAL WAVEFORM)

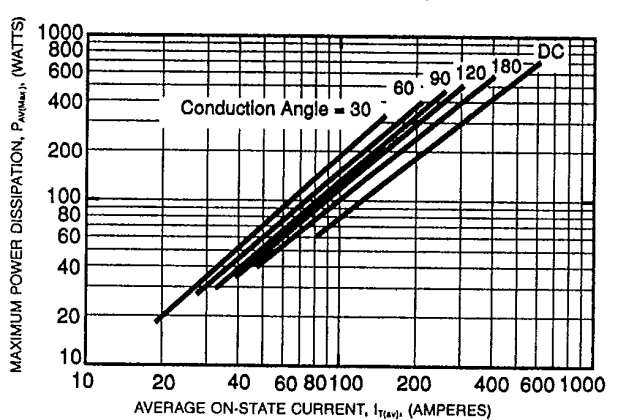

MAXIMUM ALLOWABLE CASE TEMPERATURE (RECTANGULAR WAVEFORM)

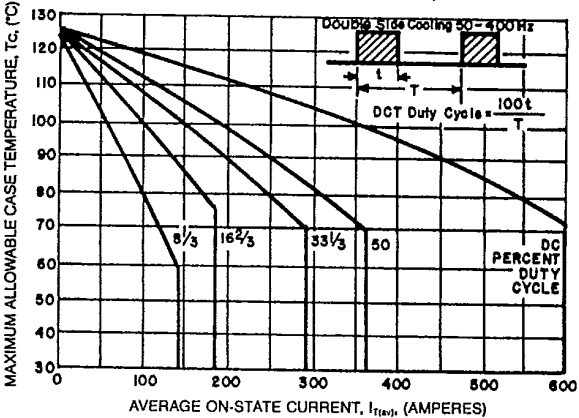

MAXIMUM ON-STATE POWER DISSIPATION (RECTANGULAR WAVEFORM)

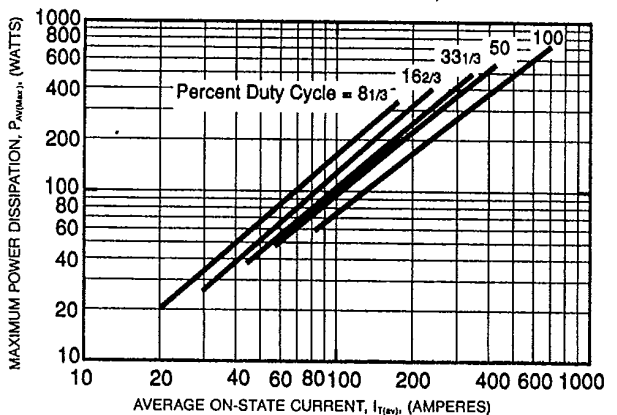



Powerex, Inc., Hillis Street, Youngwood, Pennsylvania 15697 (412) 925-7272
 Powerex Europe, S.A., 428 Ave. G. Durand, BP107, 72003 LeMans, France (43) 72.75.15

C380...X500
 Phase Control SCR
 310 Amperes Avg/800 Volts

SUB-CYCLE SURGE AND I^2t RATINGS
 (RATED LOAD CONDITIONS)

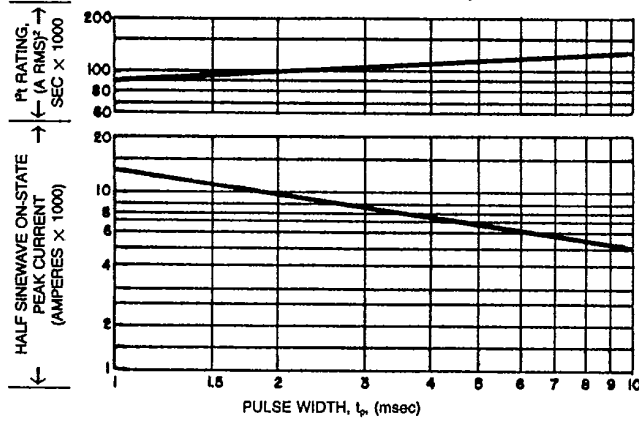

GATE CHARACTERISTICS

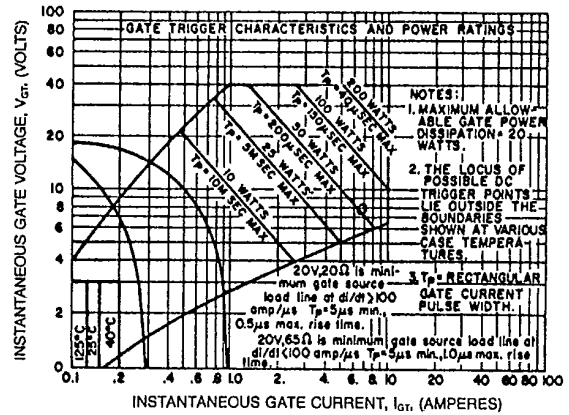

- NOTES:
1. Maximum allowable gate power dissipation = 2 watts.
 2. The locus of possible DC trigger points lie outside the boundaries shown at various case temperatures.
 3. T_p = Rectangular Gate Current Pulse Width.