

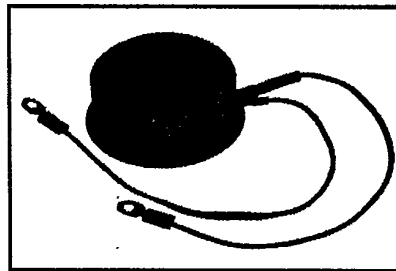

C451

Powerex, Inc. Hillis Street, Youngwood, Pennsylvania 15897 (412) 925-7272
 Powerex Europe, S.A., 428 Ave. G. Durand, BP107, 72003 LeMans, France (43) 72.75.15

Phase Control SCR
 1400-1500 Amperes Avg
 500-1800 Volts

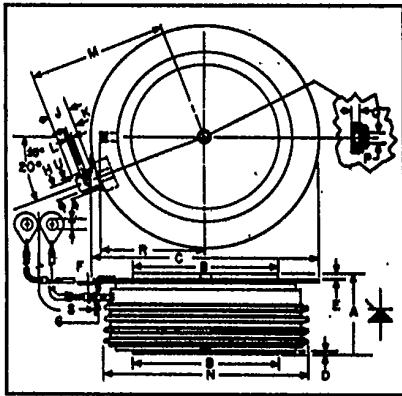

C451
 Phase Control SCR
 1400-1500 Amperes/500-1800 Volts

C451
 Outline Drawing

Dimensions	Inches		Millimeters	
	Min.	Max.	Min.	Max.
A	1.020	1.065	25.90	27.05
B	1.845	1.855	46.86	47.12
C	—	2.940	—	74.68
D	.030	—	.76	—
E	.050	—	1.27	—
F	.017	.023	.43	.58
G	.057	.059	1.44	1.50
H	.186	.191	4.72	4.85
J	.245	.255	6.22	6.48
K	.115	.130	2.92	3.30
L	.064	.070	1.62	1.78
M	—	1.800	—	45.72
N	—	2.650	—	67.31
P	.135	.145	3.42	3.68
Q	.070	.100	1.77	2.54
R	—	1.355	—	34.42
S	12.219	12.343	310.36	313.51
T	.137	.153	3.47	3.89

Description

Powerex Silicon Controlled Rectifiers (SCR) are designed for phase control applications. These are all-diffused, Press-Pak (Pow-R-Disc) devices employing the field-proven amplifying (di/namic) gate.

Features:

- Low On-State Voltage
- High di/dt
- High dv/dt
- Hermetic Packaging
- Excellent Surge and I²t Ratings

Applications:

- Power Supplies
- Battery Chargers
- Motor Control
- Light Dimmers
- VAR Generators

Ordering Information

Example: Select the complete six or seven digit part number you desire from the table - i.e. C451M1 is a 600 Volt, 1500 Ampere Phase Control SCR.

Type	Voltage		Current			
	V _{onm} V _{nom}	Code	I _r (avg)	Code		
C451	500	E	1500	1		
	600	M			1400	2
	700	S				
	800	N				
	900	T				
	1000	P				
	1100	PA				
	1200	PB				
	1300	PC				
	1400	PD				
	1500	PE				
	1600	PM				
1700	PS					
1800	PN					



Powerex, Inc., Hillis Street, Youngwood, Pennsylvania 15697 (412) 925-7272

Powerex Europe, S.A., 428 Ave. G. Durand, BP107, 72003 LeMans, France (43) 72.75.15

C451

Phase Control SCR

1400-1500 Amperes Avg/500-1800 Volts

Absolute Maximum Ratings

	Symbol	C451-1	C451-2	Units
RMS On-State Current	$I_{T(RMS)}$	2350	2200	Amperes
Average On-State Current	$I_{T(av)}$	1500	1400	Amperes
Peak One-Cycle Surge (Non Repetitive) On-State Current (60Hz)	I_{TSM}	23,000	21,000	Amperes
Peak One-Cycle Surge (Non-Repetitive) On-State Current (50Hz)	I_{TSM}	20,800	19,200	Amperes
Critical Rate-of-Rise of On-State Current (Non-Repetitive)	di/dt	400	400	Amperes/ μ s
Critical Rate-of-Rise of On-State Current (Repetitive)	di/dt	75	75	Amperes/ μ s
I^2t (for Fusing), One Cycle at 60Hz	I^2t	2,200,000	1,830,000	A^2 sec
Peak Gate Power Dissipation	P_{GM}	200	200	Watts
Average Gate Power Dissipation	$P_{G(av)}$	5	5	Watts
Storage Temperature	T_{STG}	-40 to 150	-40 to 150	$^{\circ}$ C
Operating Temperature	T_J	-40 to 125	-40 to 125	$^{\circ}$ C
Mounting Force [Ⓞ]		5500 to 6000	5500 to 6000	lb.
Mounting Force [Ⓞ]		24.5 to 26.7	24.5 to 26.7	kN

Electrical and Thermal Characteristics

Characteristics	Symbol	Test Conditions	C451-1	C451-2	Units
Current—Conducting State Maximums					
Peak On-State Voltage	V_{TM}	$T_J = 25^{\circ}$ C; $I_{TM} = 3000A$ Peak, Duty Cycle $\leq 0.01\%$	1.70	1.90	Volts
C451					
Voltage—Blocking State Maximums					
Forward Leakage, Peak	I_{DFM}	$T_J = 125^{\circ}$ C, $V = V_{DFM}$	45		mA
Reverse Leakage, Peak	I_{RRM}	$T_J = 125^{\circ}$ C, $V = V_{RRM}$	45		mA
Switching					
Typical Turn-Off Time	t_q	$T_J = 125^{\circ}$ C, $I_T = 2000A$, Pulse Width = 1000 μ sec; $V_R = 50V$; $dv/dt = 200 V/\mu$ sec; Linear to $.8 V_{DRM}$; $di_R/dt = 25A/\mu$ sec; $V_G = 0$, $R_L = 100\Omega$	150		μ sec
Typical Delay Time	t_d	$T_J = 25^{\circ}$ C, $I_T = 50A$, Gate Supply = 20V; $R_L = 20\Omega$; Rise Time = 0.1/ μ sec		.7	μ sec
Min. Critical dv/dt exponential to V_{DRM}	dv/dt	$T_J = 125^{\circ}$ C, 0.8 V_{DRM} Applied	400		V/ μ sec
Thermal					
Maximum Thermal Resistance, [Ⓞ] double sided cooling Junction to Case	$R_{\theta JC}$.025	$^{\circ}$ C/Watt
Case to Sink, Lubricated	$R_{\theta CS}$.0075	$^{\circ}$ C/Watt
Gate—Maximum Parameters					
Gate Current to Trigger	I_{GT}	$T_J = 25^{\circ}$ C, $V_D = 20Vdc$, $R_L = 3\Omega$	200		mA
Gate Voltage to Trigger	V_{GT}	$T_J = -40$ to 125° C, $V_D = 20Vdc$, $R_L = 3\Omega$	5		Volts
Non-Triggering Gate Voltage	V_{GDM}	$V_D = \text{rated } V_{DRM}$, $T_J = 125^{\circ}$ C, $R_L 1000\Omega$.15		Volts
Peak Forward Gate Current	I_{GTM}		10		Amperes
Peak Reverse Gate Voltage	V_{GRM}		5		Volts

[Ⓞ] Consult recommended mounting procedures.



Powerex, Inc., Hillis Street, Youngwood, Pennsylvania 15697 (412) 925-7272
 Powerex Europe, S.A., 428 Ave. G. Durand, BP107, 72003 LeMans, France (43) 72.75.15

C451
 Phase Control SCR
 1400-1500 Amperes Avg/500-1800 Volts

MAXIMUM ON-STATE CHARACTERISTICS

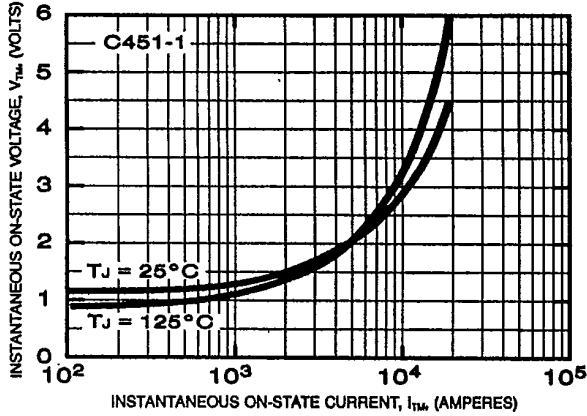

TRANSIENT THERMAL IMPEDANCE CHARACTERISTICS (JUNCTION TO CASE)

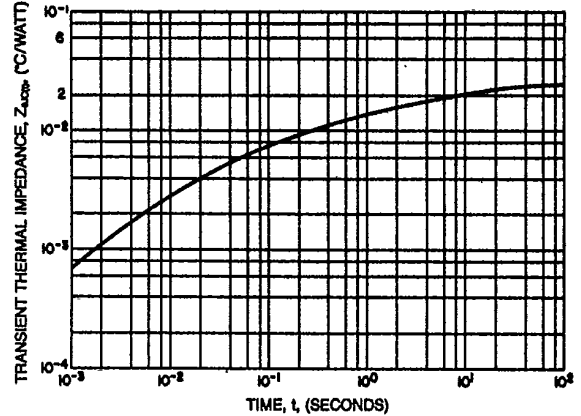

MAXIMUM ALLOWABLE CASE TEMPERATURE (SINUSOIDAL WAVEFORM)

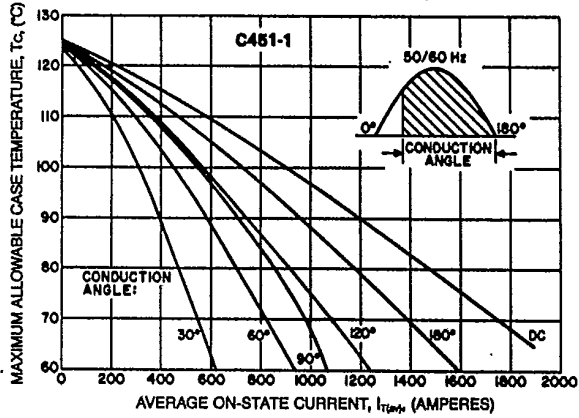

MAXIMUM ON-STATE POWER DISSIPATION (SINUSOIDAL WAVEFORM)

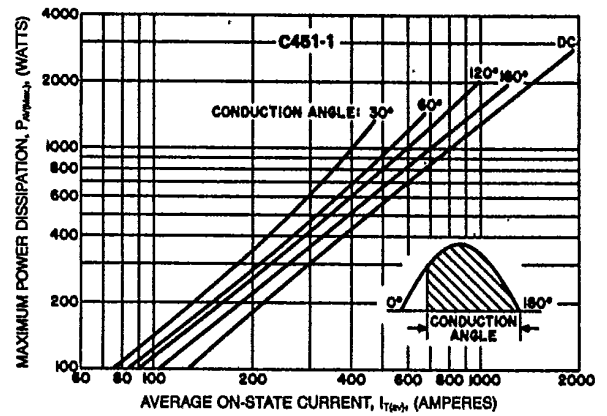

MAXIMUM ALLOWABLE CASE TEMPERATURE (RECTANGULAR WAVEFORM)

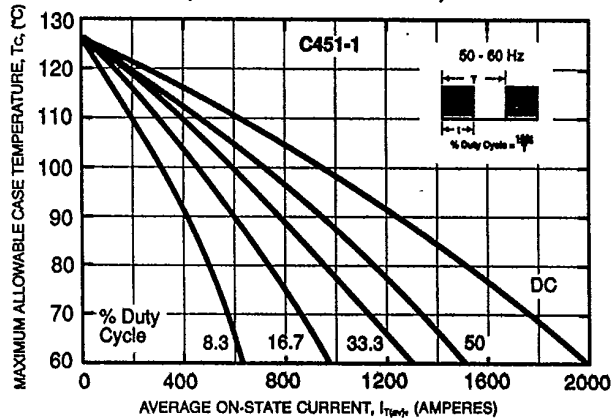

MAXIMUM ON-STATE POWER DISSIPATION (RECTANGULAR WAVEFORM)

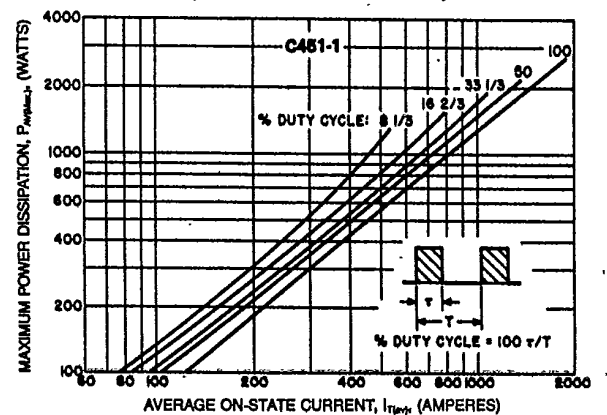



Powerex, Inc., Hillis Street, Youngwood, Pennsylvania 15697 (412) 925-7272
 Powerex Europe, S.A., 428 Ave. G. Durand, BP107, 72003 LeMans, France (43) 72.75.15

C451
 Phase Control SCR
 1400-1500 Amperes Avg/500-1800 Volts

MAXIMUM ON-STATE CHARACTERISTICS

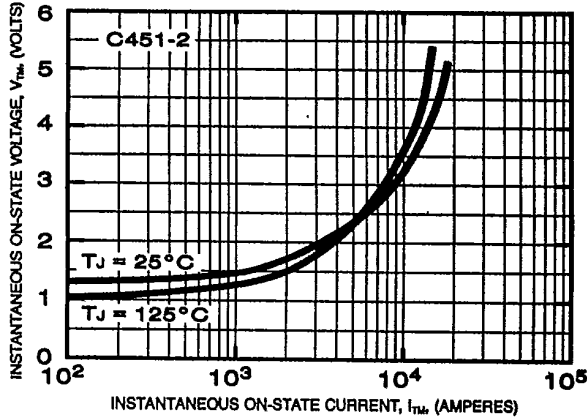

TRANSIENT THERMAL IMPEDANCE CHARACTERISTICS (JUNCTION TO CASE)

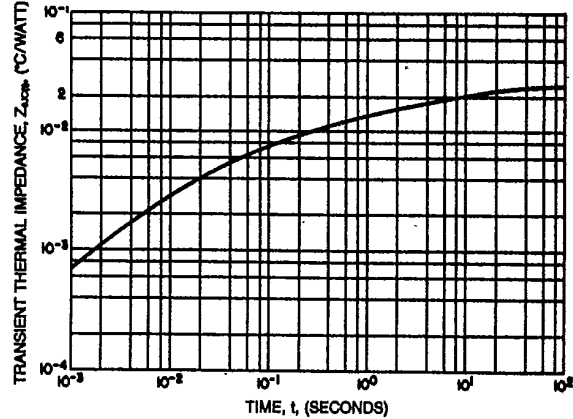

MAXIMUM ALLOWABLE CASE TEMPERATURE (SINUSOIDAL WAVEFORM)

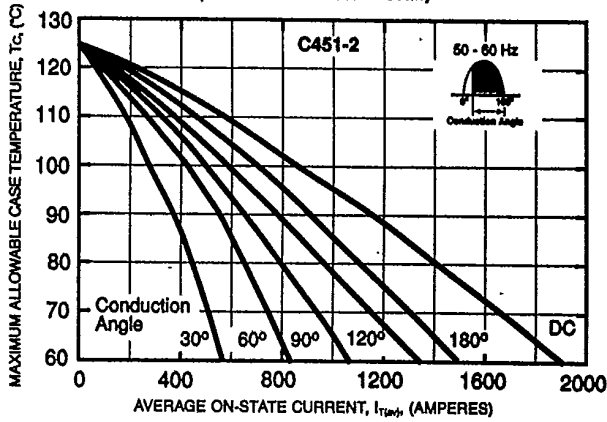

MAXIMUM ON-STATE POWER DISSIPATION (SINUSOIDAL WAVEFORM)

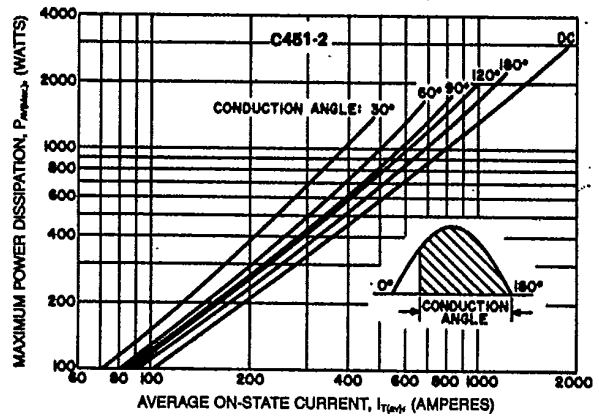

MAXIMUM ALLOWABLE CASE TEMPERATURE (RECTANGULAR WAVEFORM)

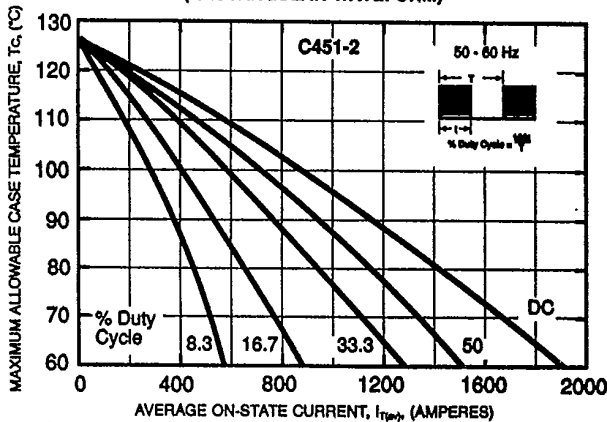

MAXIMUM ON-STATE POWER DISSIPATION (RECTANGULAR WAVEFORM)

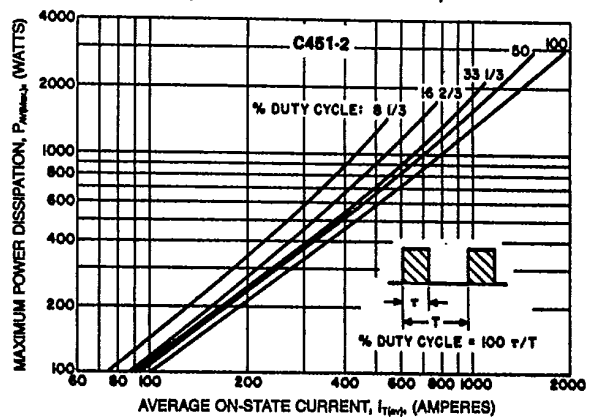



Powerex, Inc., Hillis Street, Youngwood, Pennsylvania 15697 (412) 925-7272
 Powerex Europe, S.A., 428 Ave. G. Durand, BP107, 72003 LeMans, France (43) 72.75.15

C451
Phase Control SCR
 1400-1500 Amperes Avg/500-1800 Volts

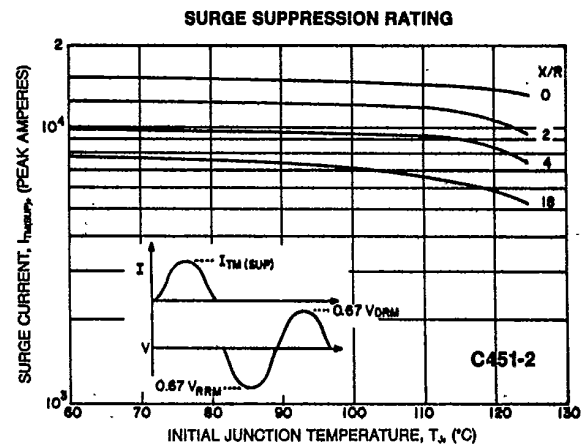
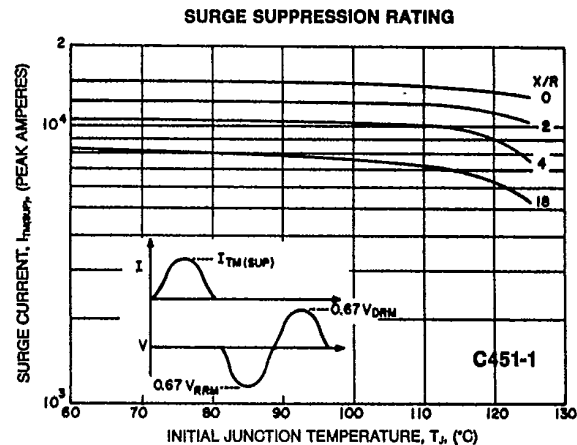
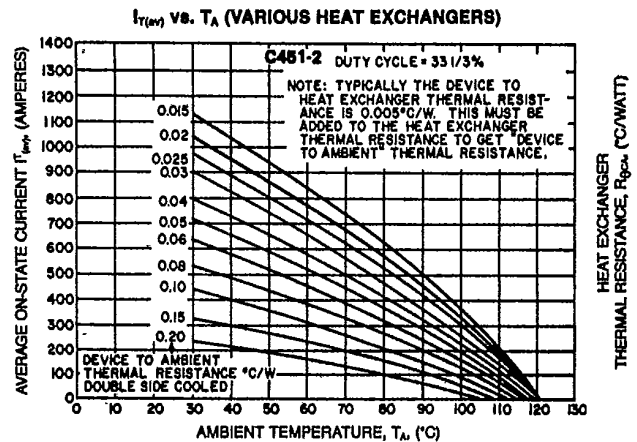
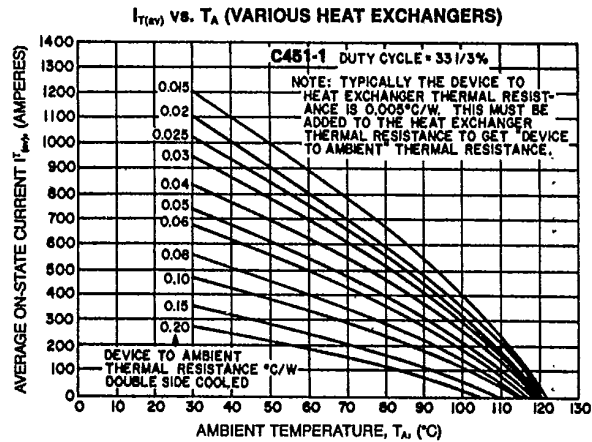
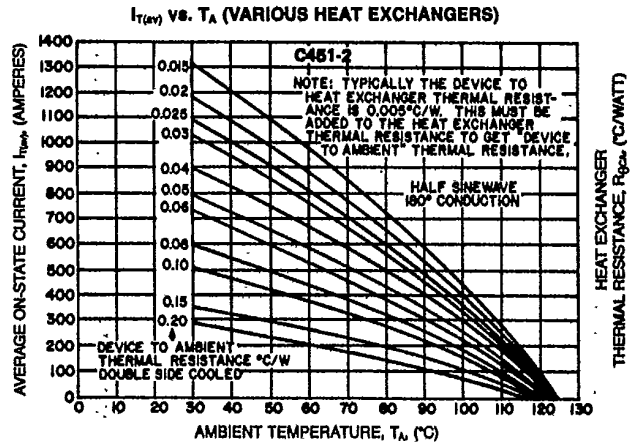
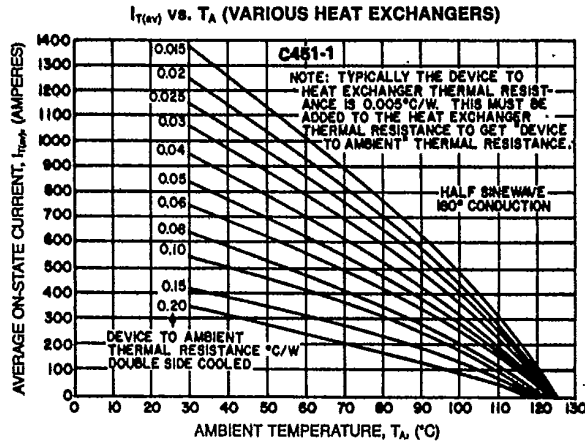



Powerex, Inc., Hillis Street, Youngwood, Pennsylvania 15697 (412) 925-7272

Powerex Europe, S.A., 428 Ave. G. Durand, BP107, 72003 LeMans, France (43) 72.75.15

C451

Phase Control SCR

1400-1500 Amperes Avg/500-1800 Volts

TYPICAL RECOVERY CURRENT

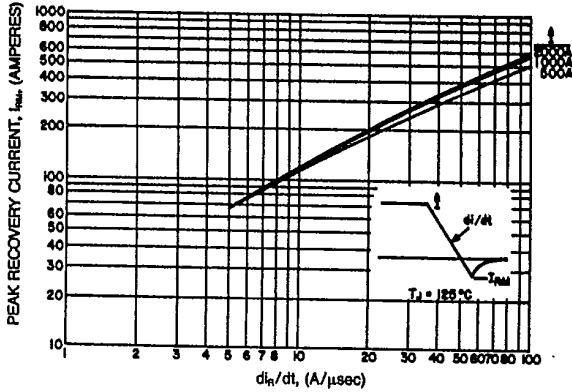

SUB-CYCLE SURGE AND I_T RATINGS (RATED LOAD CONDITIONS)

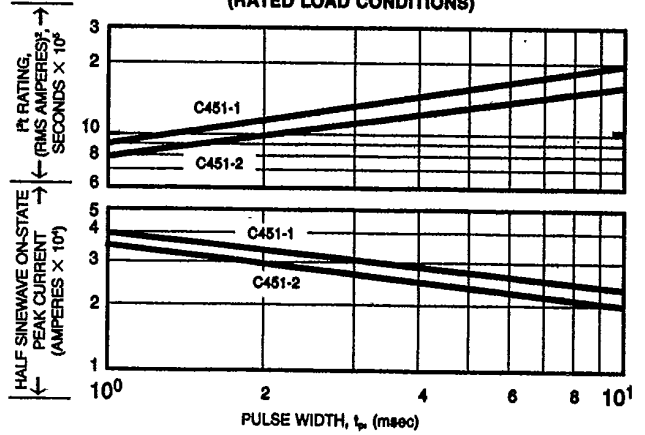

GATE CHARACTERISTICS

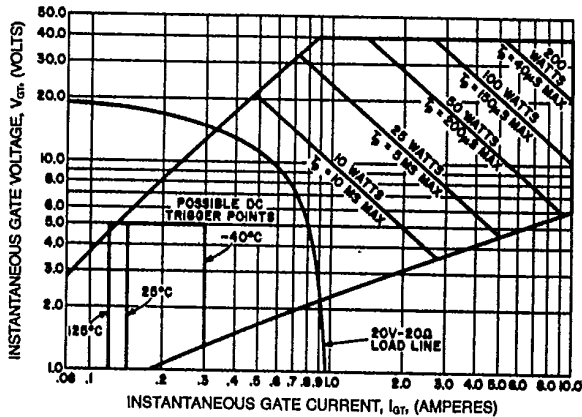

NOTES:

1. Maximum allowable average gate dissipation = 5 watts.
2. The locus of possible dc trigger points lies outside the boundaries shown at various case temperatures.
3. t_p = rectangular gate current pulse width (5 μ s min. duration, 1 μ s max. rise time).
4. Maximum long-term, repetitive anode di/dt = 75 amps/ μ s with 20V-20 Ω gate source.