

Main ratings

Drain-source voltage $V_{DS} = 400$ V
 Continuous drain current $I_D = 5,9$ A
 Drain-source on-resistance $R_{DS(on)} = 1,0 \Omega$

N-Channel

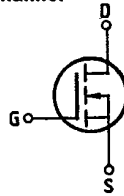

Description SIPMOS, N-channel, enhancement mode
Case Metal case 3A2 in accordance with DIN 41872, or TO 204 AA (TO 3) in accordance with JEDEC. Approx. weight 12 g

Type	Ordering code
BUZ 63	C67078-A1016-A2

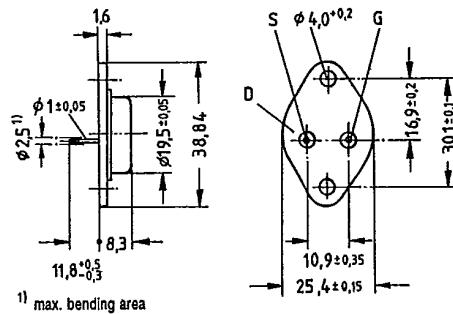

Dimensions in mm

Maximum ratings

Description	Symbols	Ratings	Units	Conditions
Drain-source voltage	V_{DS}	400	V	
Drain-gate voltage	V_{DGR}	400	V	$R_{GS} = 20 \text{ k}\Omega$
Continuous drain current	I_D	5,9	A	$T_C = 25 \text{ }^\circ\text{C}$
Pulsed drain current	I_{Dpuls}	23	A	$T_C = 25 \text{ }^\circ\text{C}$
Gate-source voltage	V_{GS}	± 20	V	
Max. power dissipation	P_D	78	W	$T_C = 25 \text{ }^\circ\text{C}$
Operating and storage temperature range	T_J T_{stg}	$-55 \dots +150$	$^\circ\text{C}$	
DIN humidity category		C	-	DIN 40 040
IEC climatic category		55/150/56	-	DIN IEC 68-1

Thermal resistance

Chip - case	R_{thJC}	$\leq 1,6$	K/W
Chip - ambient	R_{thJA}	≤ 35	K/W

SIEMENS AKTIENGESELLSCHAFT

Electrical characteristics(at $T_j = 25^\circ\text{C}$ unless otherwise specified)

Description	Symbol	Characteristics			Unit	Conditions
		min.	typ.	max.		
Static ratings						
Drain-source breakdown voltage	$V_{(BR)DSS}$	400	—	—	V	$V_{GS} = 0V$ $I_D = 0,25mA$
Gate threshold voltage	$V_{GS(th)}$	2,1	3,0	4,0		$V_{DS} = V_{GS}$ $I_D = 1mA$
Zero gate voltage drain current	I_{DSS}	—	20	250	μA	$T_j = 25^\circ\text{C}$ $T_j = 125^\circ\text{C}$ $V_{DS} = 400V$ $V_{GS} = 0V$
Gate-source leakage current	I_{GSS}	—	10	100	nA	$V_{GS} = 20V$ $V_{DS} = 0V$
Drain-source on-resistance	$R_{DS(on)}$	—	0,9	1,0	Ω	$V_{GS} = 10V$ $I_D = 2,5A$

Dynamic ratings

Forward transconductance	g_{fs}	1,7	2,5	—	S	$V_{DS} = 25V$ $I_D = 2,5A$
Input capacitance	C_{iss}	—	1,5	2,0	nF	$V_{GS} = 0V$
Output capacitance	C_{oss}	—	120	180	pF	$V_{DS} = 25V$ $f = 1MHz$
Reverse transfer capacitance	C_{rss}	—	35	60		
Turn-on time t_{on} ($t_{on} = t_{d(on)} + t_r$)	$t_{d(on)}$	—	30	45	ns	$V_{CC} = 30V$ $I_D = 2,7A$ $V_{GS} = 10V$ $R_{GS} = 50\Omega$
	t_r	—	40	60		
Turn-off time t_{off} ($t_{off} = t_{d(off)} + t_f$)	$t_{d(off)}$	—	110	140		
	t_f	—	50	65		

Reverse diode

Continuous reverse drain current	I_{DR}	—	—	5,9	A	$T_C = 25^\circ\text{C}$
Pulsed reverse drain current	I_{DRM}	—	—	23		
Diode forward on-voltage	V_{SD}	—	1,2	1,65	V	$I_F = 2 \times I_{DR}$ $V_{GS} = 0V, T_j = 25^\circ\text{C}$
Reverse recovery time	t_{rr}	—	1000	—	ns	$T_j = 25^\circ\text{C}$
Reverse recovery charge	Q_{rr}	—	5	—	μC	$I_F = I_{DR}$ $dI_F/dt = 100A/\mu s$ $V_R = 100V$

SIEMENS AKTIENGESELLSCHAFT

Power dissipation $P_D = f(T_C)$

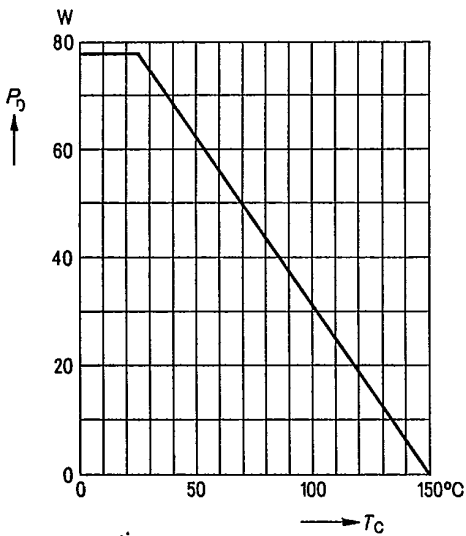

Typical output characteristics $I_D = f(V_{DS})$
parameter: 80 μ s pulse test,
 $T_j = 25^\circ\text{C}$

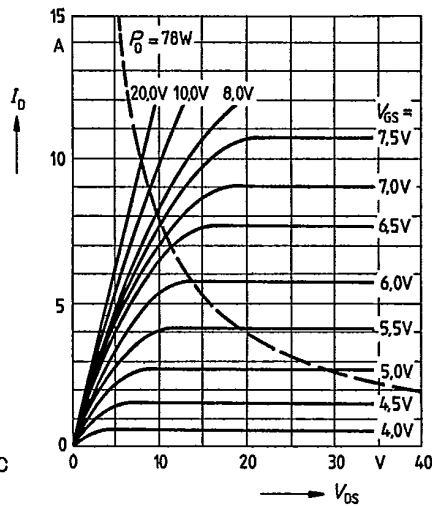

Safe operating area $I_D = f(V_{DS})$
parameter: $D = 0.01$, $T_C = 25^\circ\text{C}$

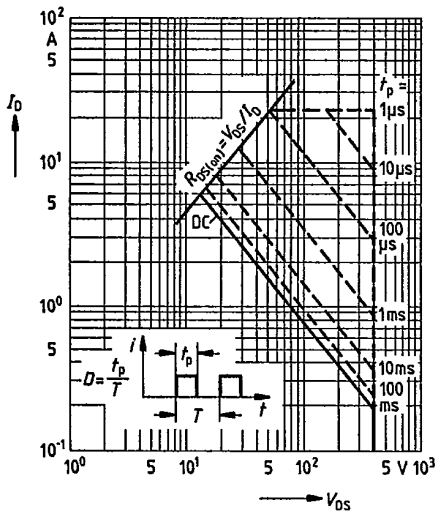

Typical transfer characteristic $I_D = f(V_{GS})$
parameter: 80 μ s pulse test,
 $V_{DS} = 25\text{V}$, $T_j = 25^\circ\text{C}$

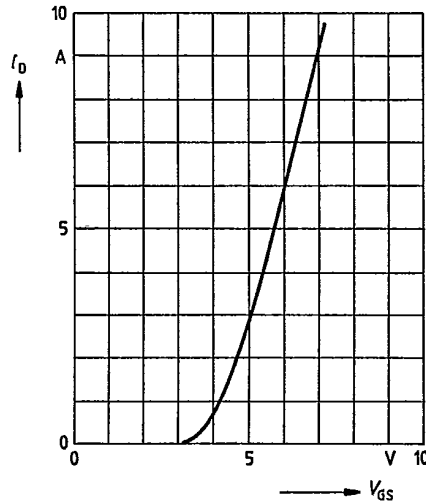

SIEMENS AKTIENGESELLSCHAFT

Typical drain-source on-state resistance

$R_{DS(on)} = f(I_D)$
parameter: $V_{GS}; T_j = 25^\circ\text{C}$

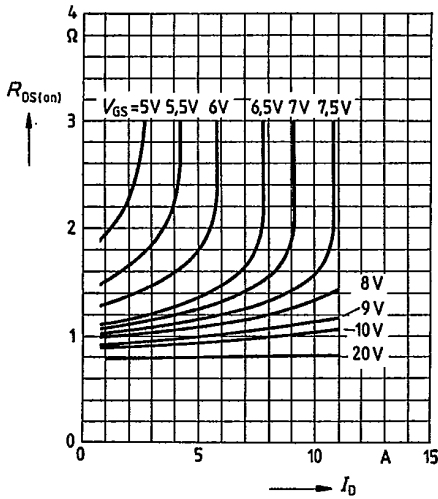

Drain-source on-state resistance

$R_{DS(on)} = f(T_j)$
parameter: $I_D = 2.5\text{A}, V_{GS} = 10\text{V}$
(spread)

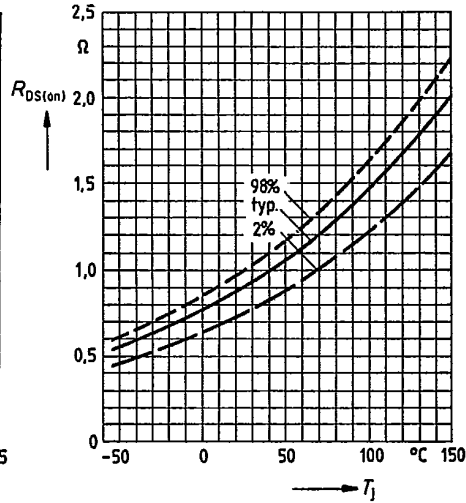

Typical transconductance $g_{fs} = f(I_D)$

parameter: 80 μs pulse test,
 $V_{DS} = 25\text{V}, T_j = 25^\circ\text{C}$

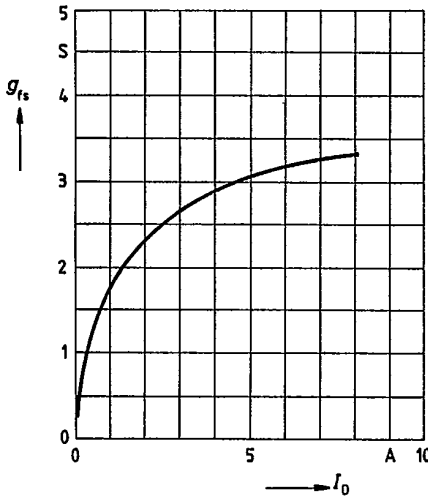

Gate threshold voltage $V_{GS(th)} = f(T_j)$

parameter: $V_{DS} = V_{GS}, I_D = 1\text{mA}$
(spread)

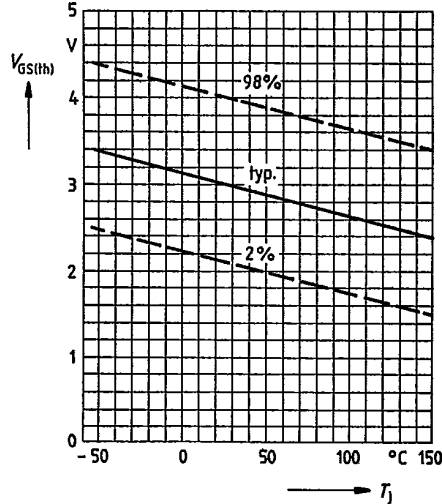

Typical capacitances $C = f(V_{DS})$
parameter: $V_{GS} = 0, f = 1\text{MHz}$

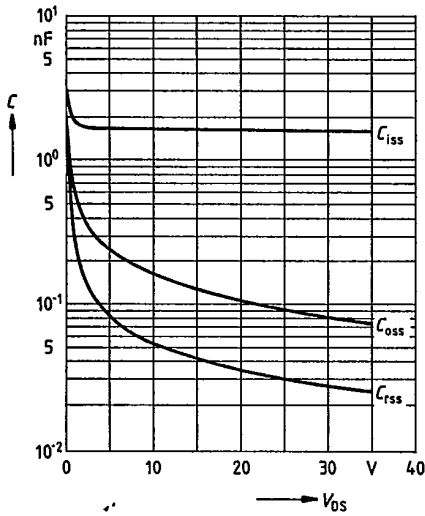

Continuous drain current $I_D = f(T_C)$
parameter: $V_{GS} \geq 10\text{V}$

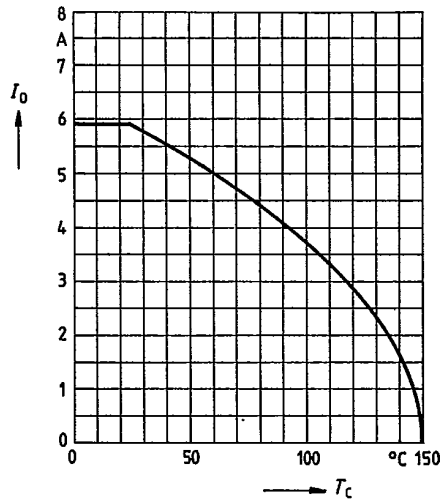

Forward characteristic of reverse diode

$I_F = f(V_{SD})$
parameter: $T_j, t_p = 80 \mu\text{s}$
(spread)

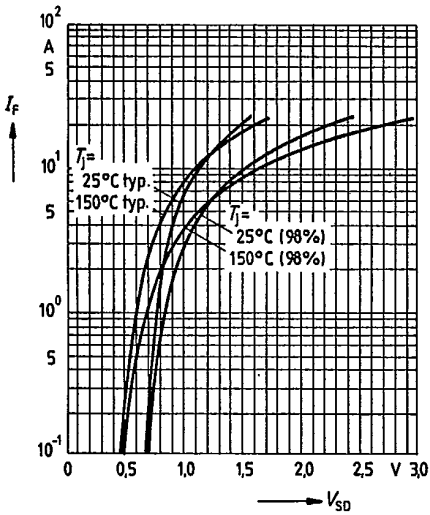

SIEMENS AKTIENGESELLSCHAFT

Transient thermal impedance $Z_{thJC} = f(t)$
 parameter: $D = t_p / T$

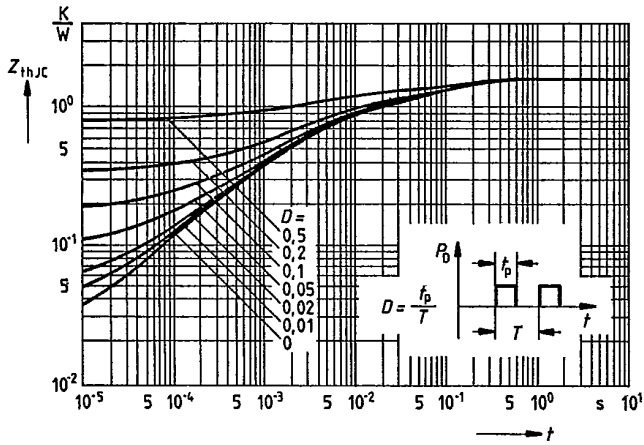

Typical gate-charge $V_{GS} = f(Q_{Gate})$
 parameter: $I_{D pulse} = 8,3A$

