

Analog Peripherals

24-Bit ADC

- 0.0015% nonlinearity
- Programmable throughput up to 1 ksp/s
- 8 external inputs; programmable as single-ended or differential
- Programmable amplifier gain: 128, 64, 32, 16, 8, 4, 2, 1
- Data-dependent windowed interrupt generator
- Built-in temperature sensor (± 3 °C)

Two 8-Bit Current DACs

Comparator

- 16 Programmable hysteresis values and response time
- Configurable to generate interrupts or reset
- Low current (0.4 μ A)

Internal Voltage Reference

V_{DD} Monitor/Brown-out Detector

On-Chip Debug

- On-chip debug circuitry facilitates full speed, non-intrusive in-system debug (no emulator required)
- Provides breakpoints, single stepping, watchpoints
- Inspect/modify memory, registers, and stack
- Superior performance to emulation systems using ICE-chips, target pods, and sockets

Supply Voltage: 2.7 to 3.6 V

- Typical operating current: 17 mA at 50 MHz
16 μ A at 32 kHz
- Typical stop mode current: <0.1 μ A

Temperature Range: -40 to +85 °C

High-Speed 8051 μ C Core

- Pipelined instruction architecture; executes 70% of instructions in 1 or 2 system clocks
- Up to 50 MIPS throughput with 50 MHz clock
- Expanded interrupt handler

Memory

- 768 bytes data RAM
- 8 kB Flash; in-system programmable in 512 byte sectors (512 bytes are reserved)

Digital Peripherals

- 17 port I/O; all 5 V tolerant
- Hardware SMBus™ (I2C™ compatible), SPI™, and UART serial ports available concurrently
- 16-bit programmable counter array with three capture/compare modules, WDT
- 4 general-purpose 16-bit counter/timers
- Realtime clock mode using PCA or timer and external clock source

Clock Sources

- Internal oscillator: 24.5 MHz, 2% accuracy supports UART operation
- External oscillator: Crystal, RC, C, or clock (1 or 2 pin modes)
- 2x clock multiplier to achieve 50 MHz internal clock
- Can switch between clock sources on-the-fly

Package

- 28-pin QFN (lead-free package)

Ordering Part Numbers

- C8051F351-GM

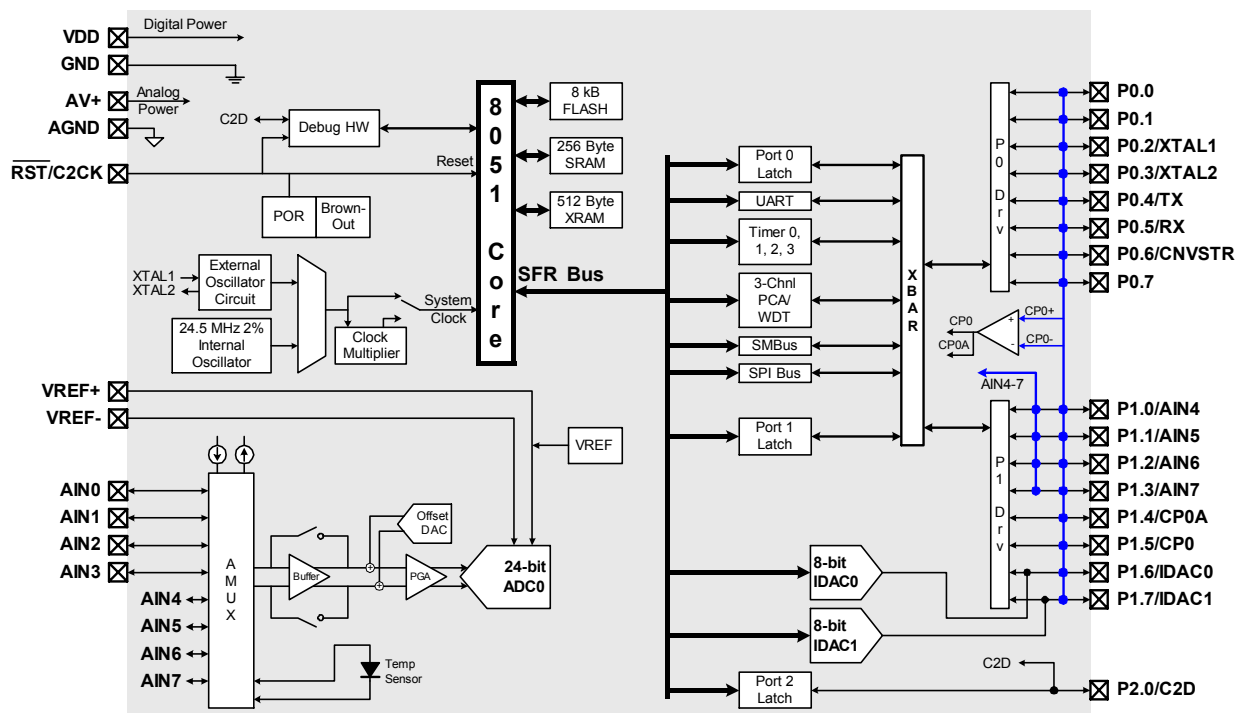

Selected Electrical Specifications

($T_A = -40$ to $+85$ °C, $V_{DD} = AV+ = 3.0$ V, $V_{REF} = 2.5$ V External, PGA Gain = 1x, MDCLK = 2.4567 MHz, Decimation Ratio = 1920 unless otherwise specified)

PARAMETER	CONDITIONS	MIN	TYP	MAX	UNITS
GLOBAL CHARACTERISTICS					
Supply Voltage		2.7		3.6	V
Supply Current (CPU active)	Clock = 50 MHz Clock = 1 MHz Clock = 32 kHz; V_{DD} Monitor Enabled		17 0.5 16		mA mA μ A
Supply Current (shutdown)	Oscillator not running; V_{DD} Monitor Disabled		0.1		μ A
Clock Frequency Range		DC		50	MHz
24-BIT A/D CONVERTER					
Resolution	(no missing codes)		24		bits
Integral Nonlinearity	Single-ended Mode Differential Mode			± 15	ppm FS
Offset Error			± 5		ppm
Gain Error			± 0.002		%
Common Mode Rejection Ratio (CMRR)			110		dB
Power Supply Rejection, DC		80			dB
Power Supply Current			230		μ A
8-BIT CURRENT-MODE D/A CONVERTERS					
Resolution			8		bits
Integral Nonlinearity			± 0.5		LSB
Differential Nonlinearity	Guaranteed Monotonic		± 0.5	± 1	LSB

Package Information

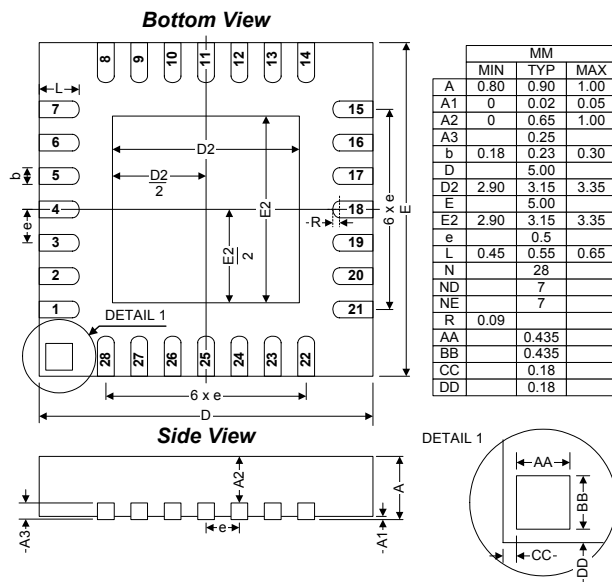

C8051F350DK Development Kit

