

## Features

- Lead free versions available
- RoHS compliant (lead free version)\*
- Low profile
- Surface mount
- Very low forward voltage drop

## Applications

- Cellular phones
- PDAs
- Desktop PCs and notebooks
- Digital cameras
- MP3 players

# CD216A-B120L ~ B140 MITE Chip Diode

## General Information

The markets of portable communications, computing and video equipment are challenging the semiconductor industry to develop increasingly smaller electronic components.

Bourns offers Schottky Rectifier Diodes for rectification applications in compact DO-216AA size chip package formats, which offer PCB real estate savings and are considerably smaller than competitive parts. The Schottky Barrier Rectifier Diodes offer a forward current of 1 A with a choice of repetitive peak reverse voltage of 20 V up to 40 V.

Bourns® Chip Diodes conform to JEDEC standards, are easy to handle with standard pick and place equipment and the flat configuration minimizes roll away.

## Electrical Characteristics (@ T<sub>A</sub> = 25 °C Unless Otherwise Noted)

Parameter	Symbol	CD216-				Unit
		B120L	B120R	B130L	B140	
Forward Voltage (Max.) (I <sub>F</sub> = 1 A)	V <sub>F</sub>	0.45	0.53	0.38	0.55	V
Typical Junction Capacitance*	C <sub>T</sub>	90	75	70	60	pF
Reverse Current (Max.) (at Rated V <sub>R</sub> )	I <sub>R</sub>	400	10	410	500	μA

\* Measured at 1.0 MHz and applied reverse voltage of 4.0 V DC.

## Absolute Ratings (@ T<sub>A</sub> = 25 °C Unless Otherwise Noted)

Parameter	Symbol	CD216-				Unit
		B120L	B120R	B130L	B140	
Repetitive Peak Reverse Voltage	V <sub>RRM</sub>	20	20	30	40	V
DC Blocking Voltage	V <sub>DC</sub>	20	20	30	40	V
RMS Voltage	V <sub>RMS</sub>	14	14	21	28	V
Average Forward Current @ T <sub>L</sub> = 130 °C	I <sub>O</sub>	1				A
Peak Forward Surge Current**	I <sub>FSM</sub>	50	50	50	40	A
Max. Instantaneous Forward Voltage*** @ I <sub>F</sub> = 0.1 A @ I <sub>F</sub> = 1.0 A @ I <sub>F</sub> = 2.0 A @ I <sub>F</sub> = 3.0 A	V <sub>F</sub>	0.34 0.45 0.65	0.455 0.53 0.595	0.30 0.38 0.52	0.36 0.55 0.85	V
Max. Instantaneous Reverse Current @ V <sub>R</sub> = 40 V @ V <sub>R</sub> = 30 V @ V <sub>R</sub> = 20 V @ V <sub>R</sub> = 10 V @ V <sub>R</sub> = 5 V	I <sub>R</sub>	0.4 0.1	0.0100 0.0010 0.0005	0.41 0.13 0.05	0.50 0.15	mA
Thermal Resistance Junction to Lead (Anode) Junction to Tab (Cathode) Junction to Ambient	R <sub>θJL</sub> R <sub>θJTAB</sub> R <sub>θJA</sub>	35 20 250				°C/W °C/W °C/W
Storage Temperature	T <sub>STG</sub>	-55 to +125				°C
Junction Temperature	T <sub>J</sub>	-55 to +150				°C

\*\* Surge Current 8.3 ms single phase, half sine wave, 60 Hz (JEDEC Method).

\*\*\* Pulse Test; Pulse Width = 300 μs, Duty Cycle = 2 %.

\*RoHS Directive 2002/95/EC Jan 27 2003 including Annex

Specifications are subject to change without notice.

Customers should verify actual device performance in their specific applications.

# CD216A-B120L ~ B140 MITE Chip Diode



## Product Dimensions

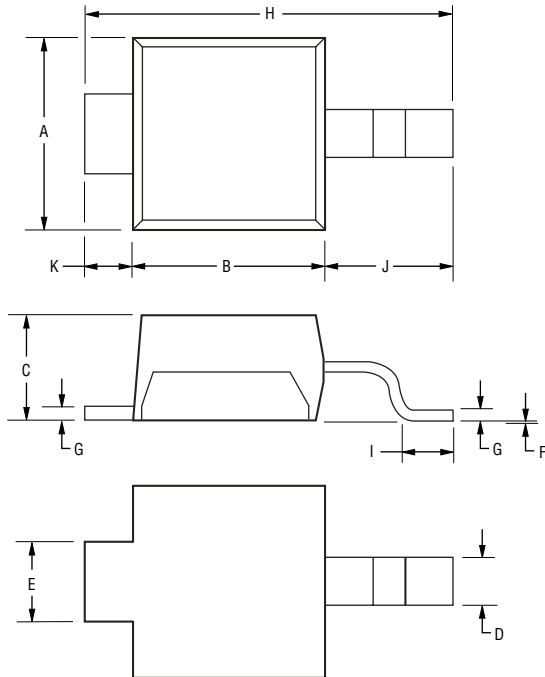

Dimension	(DO-216AA)
A	$\frac{1.75 - 2.05}{(0.069 - 0.081)}$
B	$\frac{1.80 - 2.20}{(0.071 - 0.087)}$
C	$\frac{0.95 - 1.25}{(0.037 - 0.049)}$
D	$\frac{0.42 - 0.68}{(0.017 - 0.027)}$
E	$\frac{0.70 - 1.00}{(0.028 - 0.039)}$
F	$\frac{-0.05 - +0.10}{(0.002 - 0.004)}$
G	$\frac{0.10 - 0.25}{(0.004 - 0.010)}$
H	$\frac{3.65 - 3.95}{(0.144 - 0.156)}$
I	$\frac{0.40 - 0.70}{(0.016 - 0.028)}$
J	$\frac{1.10 - 1.50}{(0.043 - 0.059)}$
K	$\frac{0.20 - 0.80}{(0.008 - 0.060)}$

DIMENSIONS:  $\frac{\text{MM}}{(\text{INCHES})}$

## Recommended Pad Layout

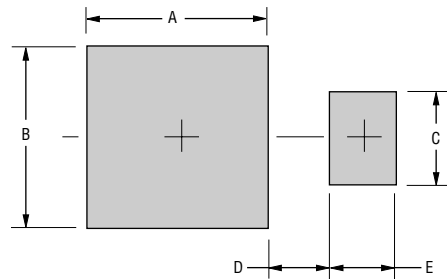

Dimension	DO-216AA
A (Max.)	$\frac{2.67}{(0.105)}$
B (Min.)	$\frac{2.54}{(0.100)}$
C (Min.)	$\frac{1.27}{(0.050)}$
D (Max.)	$\frac{0.635}{(0.025)}$
E (Min.)	$\frac{0.762}{(0.030)}$

## Physical Specifications

Case .....JEDEC DO-216AA Molded plastic  
 Polarity .....Cathode designated by TAB 1  
 Weight .....Approximately 0.016 grams  
 Mounting Position .....One way

## Typical Part Marking

CD216A-B120L .....B2L  
 CD216A-B120R .....B2E  
 CD216A-B130L .....B3L  
 CD216A-B140 .....B4S

## How To Order

**CD 216A - B 1 20 L**

Common Code \_\_\_\_\_  
 Chip Diode \_\_\_\_\_  
 Package \_\_\_\_\_  
 • 216A = DO-216AA  
 Model \_\_\_\_\_  
 B = Schottky Barrier Series  
 Average Forward Current ( $I_o$ ) Code \_\_\_\_\_  
 1 = 1 A (Code x 1000 mA = Average Forward Current)  
 Reverse Voltage ( $V_P$ ) Code \_\_\_\_\_  
 20 = 20 V  
 30 = 30 V  
 40 = 40 V  
 Forward Voltage Suffix \_\_\_\_\_  
 L = Low Forward Voltage  $V_f$  (CD216-B120L, CD216-B130L)  
 R = Low Leakage Current IR (CD216-B120R)  
 Terminations \_\_\_\_\_  
 LF = 100 % Sn (lead free)  
 Blank = Sn/Pb

# CD216A-B120L ~ B140 MITE Chip Diode



## Rating and Characteristic Curves: CD216A-B120L

### Forward Characteristics

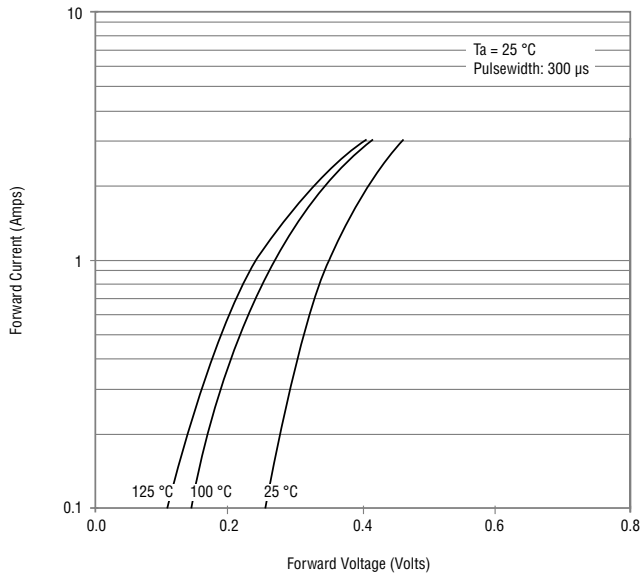

### Reverse Characteristics

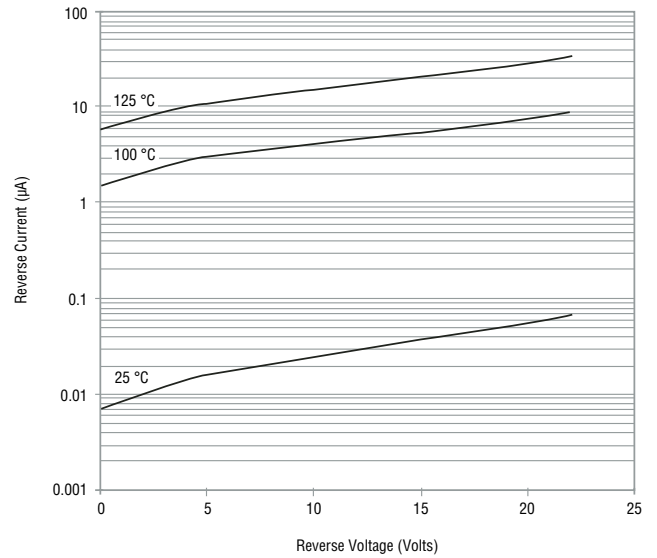

### Derating Curve

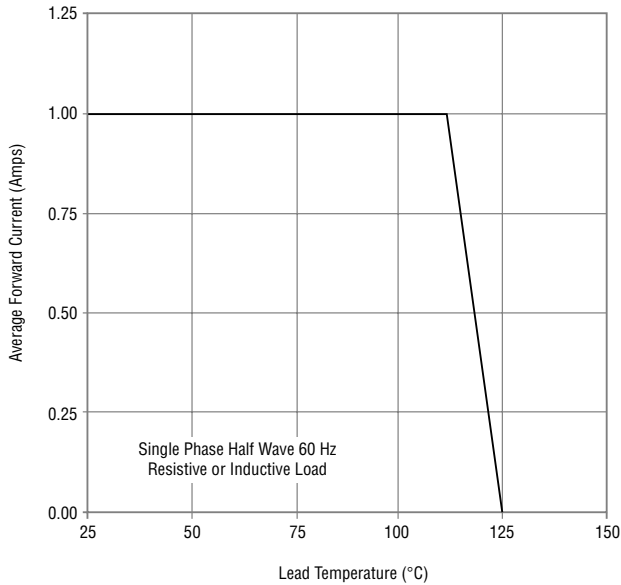

### Capacitance Between Terminals

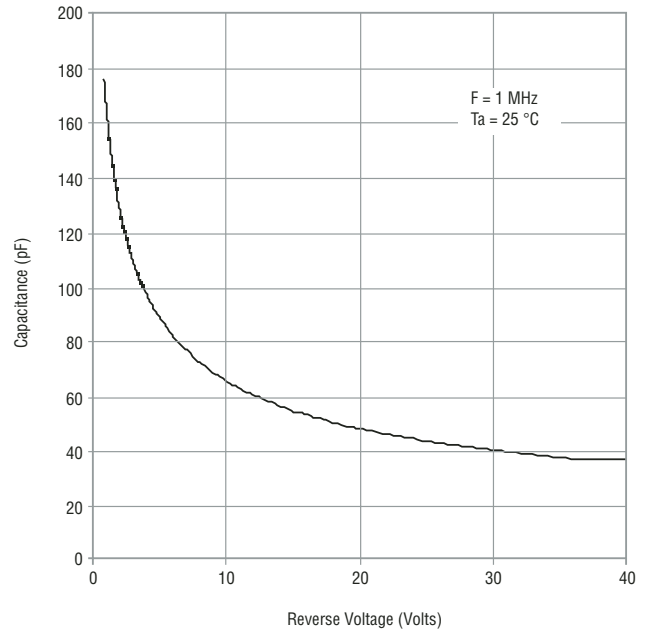

Specifications are subject to change without notice.  
Customers should verify actual device performance in their specific applications.

# CD216A-B120L ~ B140 MITE Chip Diode



## Rating and Characteristic Curves: CD216A-B120R

### Forward Characteristics

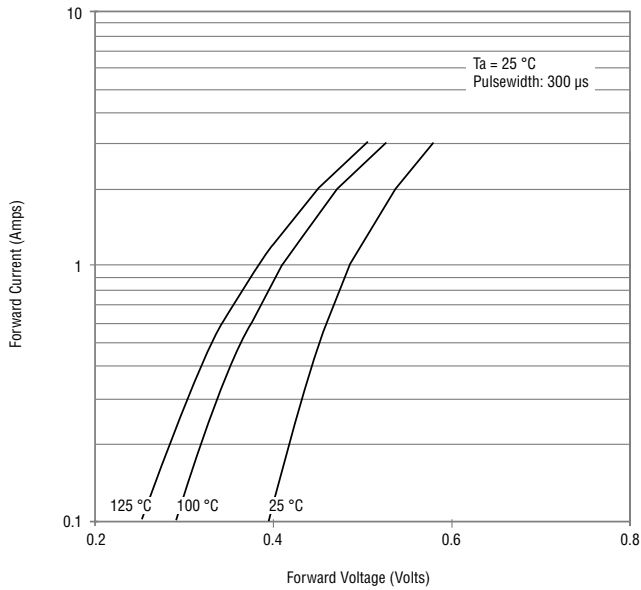

### Reverse Characteristics

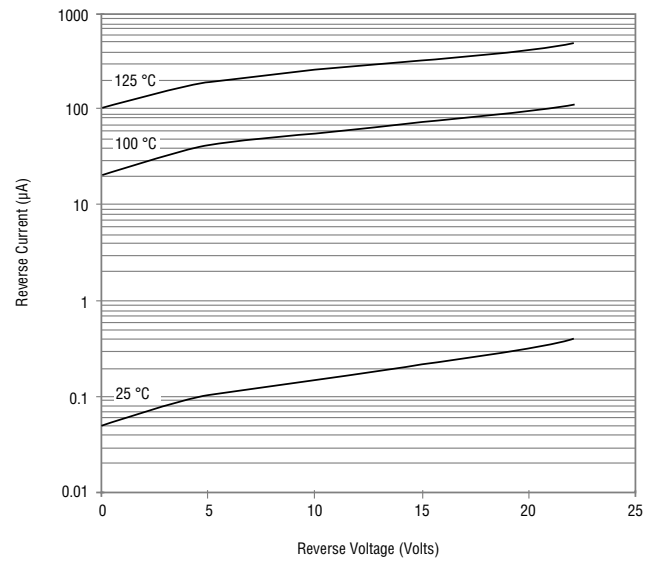

### Derating Curve

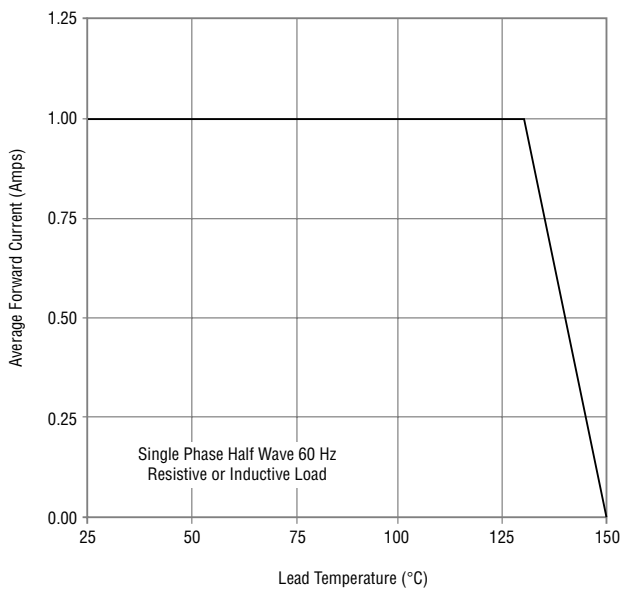

### Capacitance Between Terminals

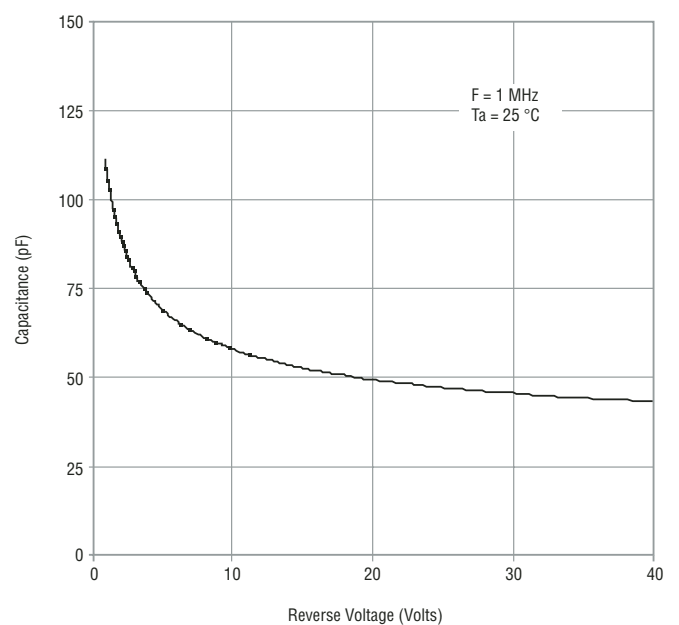

# CD216A-B120L ~ B140 MITE Chip Diode



## Rating and Characteristic Curves: CD216A-B130L

### Forward Characteristics

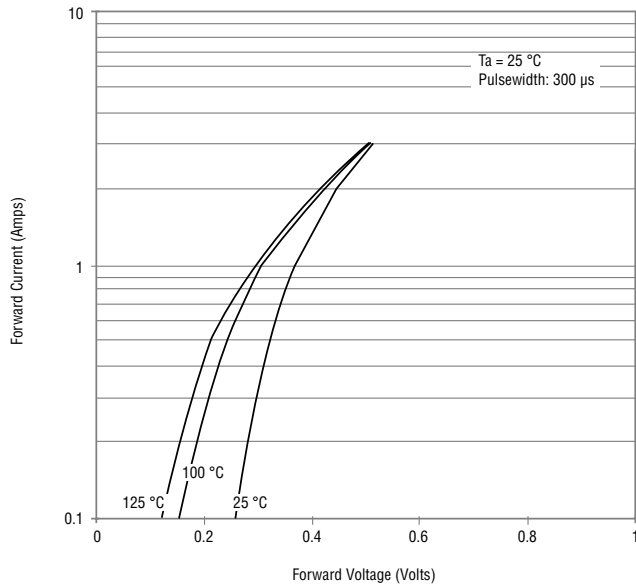

### Reverse Characteristics

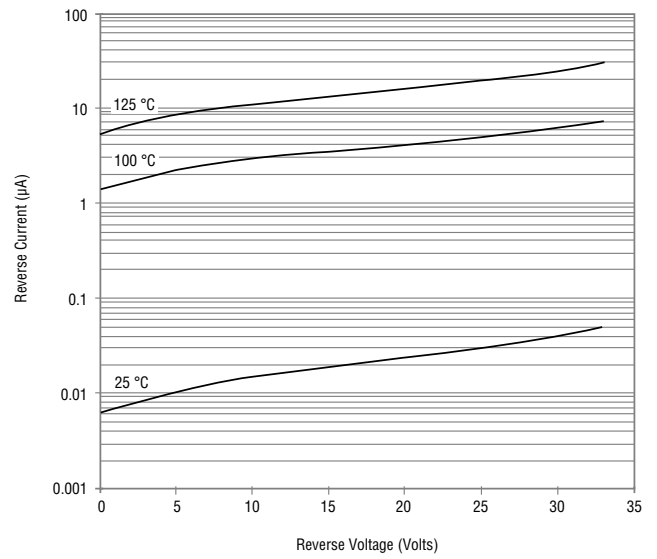

### Derating Curve

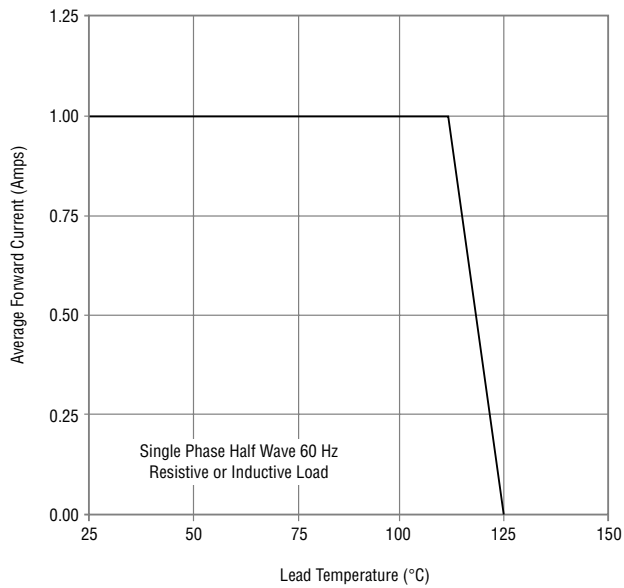

### Capacitance Between Terminals

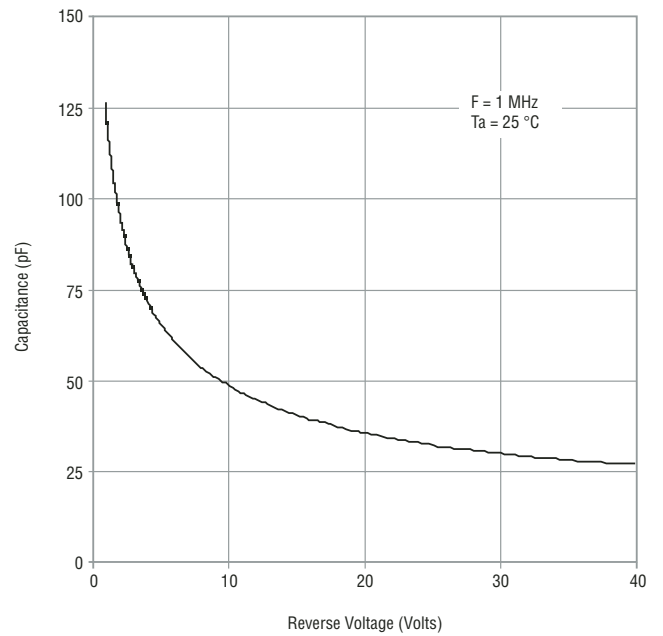

Specifications are subject to change without notice.  
Customers should verify actual device performance in their specific applications.

# CD216A-B120L ~ B140 MITE Chip Diode



## Rating and Characteristic Curves: CD216A-B140

### Forward Characteristics

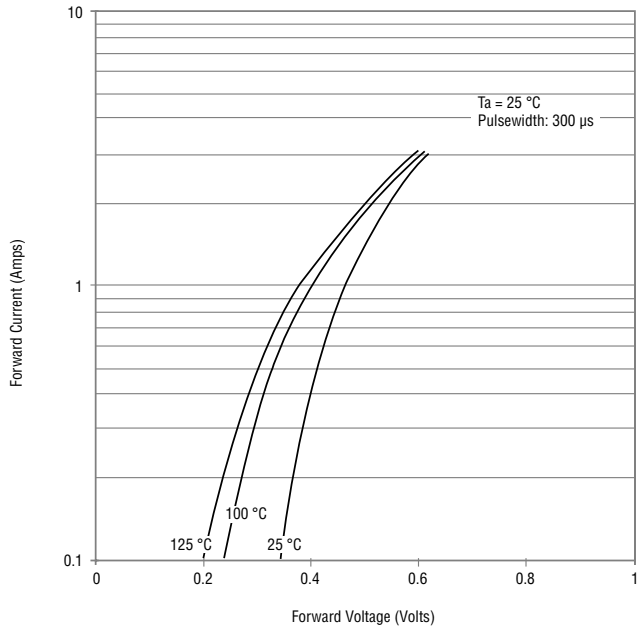

### Reverse Characteristics

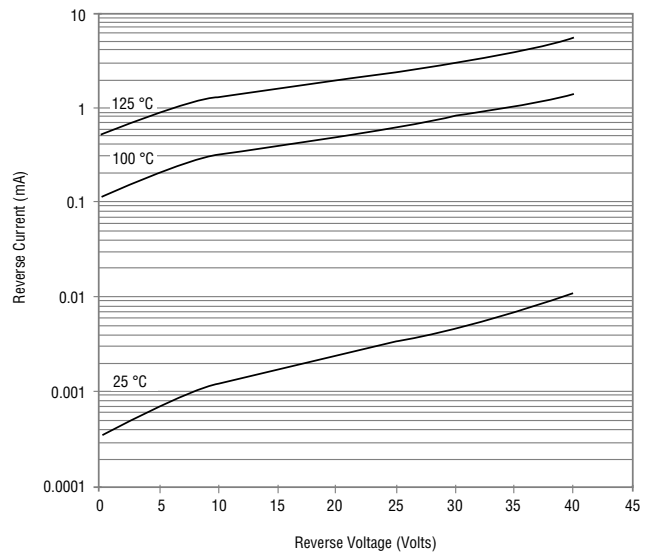

### Derating Curve

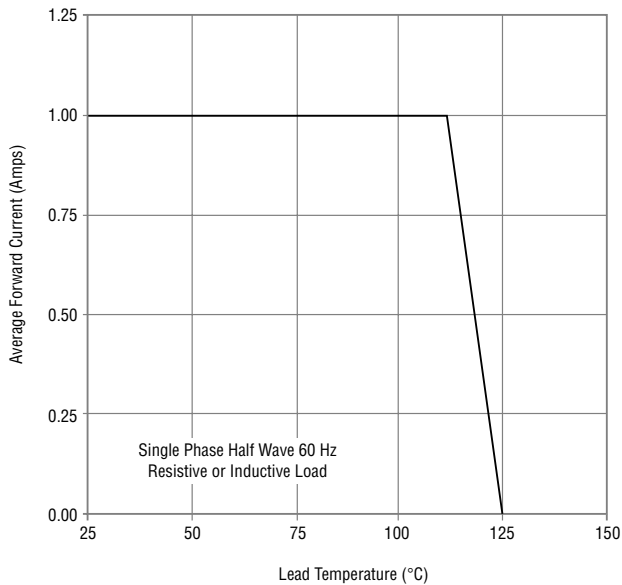

### Capacitance Between Terminals

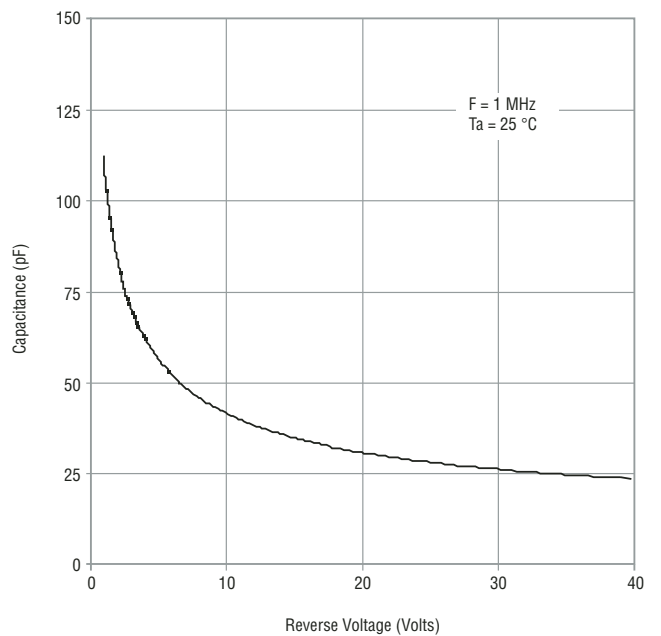

# CD216A-B120L ~ B140 MITE Chip Diode

**BOURNS®**

## Packaging Information

The product will be dispensed in Tape and Reel format (see diagram below).

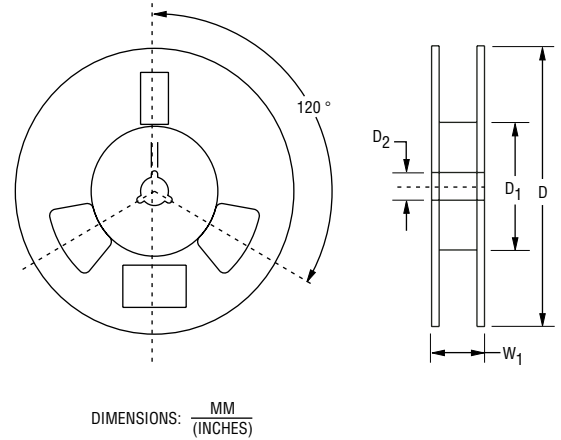
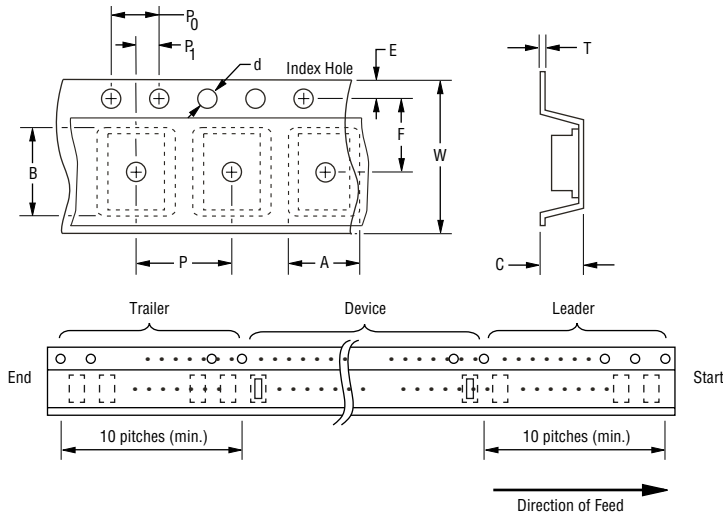

Devices are packed in accordance with EIA standard RS-481-A and specifications shown here.

Item	Symbol	DO-216AA
Carrier Width	A	$\frac{2.90 \pm 0.10}{(0.114 - 0.004)}$
Carrier Length	B	$\frac{5.30 \pm 0.10}{(0.209 - 0.004)}$
Carrier Depth	C	$\frac{1.37 \pm 0.10}{(0.054 - 0.004)}$
Sprocket Hole	d	$\frac{1.55 \pm 0.05}{(0.061 - 0.002)}$
Reel Outside Diameter	D	$\frac{330 / 178.0}{(12.992 / 7.007)}$
Reel Inner Diameter	D <sub>1</sub>	$\frac{75.0}{(2.953)}$ MIN.
Feed Hole Diameter	D <sub>2</sub>	$\frac{13.0 \pm 0.20}{(0.512 - 0.008)}$
Sprocket Hole Position	E	$\frac{1.75 \pm 0.10}{(0.069 - 0.004)}$
Punch Hole Position	F	$\frac{5.50 \pm 0.05}{(0.217 - 0.002)}$
Punch Hole Pitch	P	$\frac{4.00 \pm 0.10}{(0.157 - 0.004)}$
Sprocket Hole Pitch	P <sub>0</sub>	$\frac{4.00 \pm 0.10}{(0.157 - 0.004)}$
Embossment Center	P <sub>1</sub>	$\frac{2.00 \pm 0.05}{(0.079 - 0.002)}$
Overall Tape Thickness	T	$\frac{0.40 \pm 0.10}{(0.016 - 0.004)}$
Tape Width	W	$\frac{12.00 \pm 0.20}{(0.472 - 0.008)}$
Reel Width	W <sub>1</sub>	$\frac{18.4}{(0.724)}$ MAX.
Quantity per Reel	--	3,000

Specifications are subject to change without notice.  
Customers should verify actual device performance in their specific applications.



*Reliable Electronic Solutions*

**Asia-Pacific:**

Tel: +886-2 2562-4117 • Fax: +886-2 2562-4116

**Europe:**

Tel: +41-(0)41 768 5555 • Fax: +41-(0)41 768 5510

**The Americas:**

Tel: +1-951 781-5500 • Fax: +1-951 781-5700

[www.bourns.com](http://www.bourns.com)