

CD74HC4066, CD74HCT4066

High-Speed CMOS Logic Quad Bilateral Switch

Features

- **Wide Analog-Input-Voltage Range** **0V - 10V**
- **Low "ON" Resistance**
 - $V_{CC} = 4.5V$ **25Ω**
 - $V_{CC} = 9V$ **15Ω**
- **Fast Switching and Propagation Delay Times**
- **Low "OFF" Leakage Current**
- **Wide Operating Temperature Range** . . . **-55°C to 125°C**
- **HC Types**
 - **2V to 10V Operation**
 - **High Noise Immunity: $N_{IL} = 30\%$, $N_{IH} = 30\%$ of V_{CC} at $V_{CC} = 5V$ and $10V$**
- **HCT Types**
 - **Direct LSTTL Input Logic Compatibility, $V_{IL} = 0.8V$ (Max), $V_{IH} = 2V$ (Min)**
 - **CMOS Input Compatibility, $I_I \leq 1\mu A$ at V_{OL} , V_{OH}**

Description

The Harris CD74HC4066 and CD74HCT4066 contains four independent digitally controlled analog switches that use silicon-gate CMOS technology to achieve operating speeds similar to LSTTL with the low power consumption of standard CMOS integrated circuits.

These switches feature the characteristic linear "ON" resistance of the metal-gate CD4066B. Each switch is turned on by a high-level voltage on its control input.

Ordering Information

PART NUMBER	TEMP. RANGE (°C)	PACKAGE	PKG. NO.
CD74HC4066E	-55 to 125	14 Ld PDIP	E14.3
CD74HCT4066E	-55 to 125	14 Ld PDIP	E14.3
CD74HC4066M	-55 to 125	14 Ld SOIC	M14.15
CD74HCT4066M	-55 to 125	14 Ld SOIC	M14.15

NOTES:

1. When ordering, use the entire part number. Add the suffix 96 to obtain the variant in the tape and reel.
2. Wafer and die is available which meets all electrical specifications. Please contact your local sales office or Harris customer service for ordering information.

Pinout

CD74HC4066, CD74HCT4066
(PDIP, SOIC)
TOP VIEW

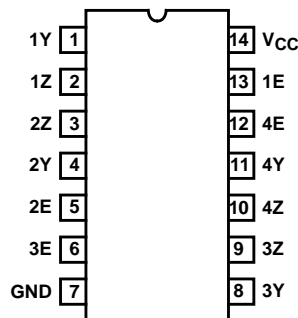

Functional Diagram

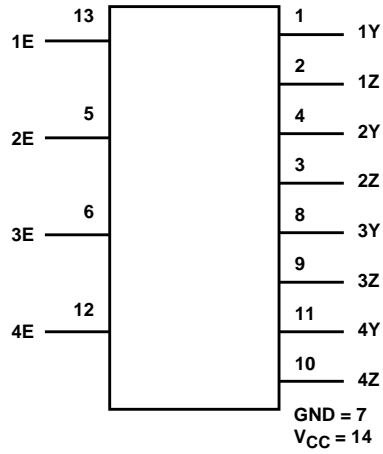

TRUTH TABLE

INPUT nE	SWITCH
L	Off
H	On

NOTE:
 H = High Level
 L = Low Level

Logic Diagram

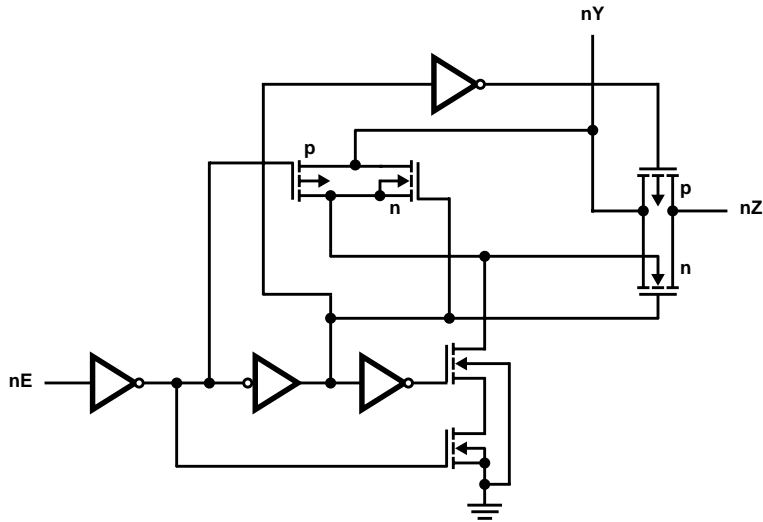

CD74HC4066, CD74HCT4066

Absolute Maximum Ratings

DC Supply Voltage, V_{CC}	
HCT Types	-0.5V to 7V
HC Types	-0.5V to 10.5V
DC Input Diode Current, I_{IK}	
For $V_I < -0.5V$ or $V_I > V_{CC} + 0.5V$	$\pm 20mA$
DC Switch Current, I_O (Note 3)	
For $-0.5V < V_O < V_{CC} + 0.5V$	$\pm 25mA$
DC Output Diode Current, I_{OK}	
For $V_O < -0.5V$ or $V_O > V_{CC} + 0.5V$	$\pm 20mA$
DC Output Source or Sink Current per Output Pin, I_O	
For $V_O > -0.5V$ or $V_O < V_{CC} + 0.5V$	$\pm 25mA$
DC V_{CC} or Ground Current, I_{CC}	$\pm 50mA$

Thermal Information

Thermal Resistance (Typical, Note 4)	θ_{JA} ($^{\circ}C/W$)
PDIP Package	90
SOIC Package	175
Maximum Junction Temperature (Hermetic Package or Die)	175 $^{\circ}C$
Maximum Junction Temperature (Plastic Package)	150 $^{\circ}C$
Maximum Storage Temperature Range	-65 $^{\circ}C$ to 150 $^{\circ}C$
Maximum Lead Temperature (Soldering 10s)	300 $^{\circ}C$ (SOIC - Lead Tips Only)

Operating Conditions

Temperature Range, T_A	-55 $^{\circ}C$ to 125 $^{\circ}C$
Supply Voltage Range, V_{CC}	
HC Types	2V to 10V
HCT Types	4.5V to 5.5V
DC Input or Output Voltage, V_I, V_O	0V to V_{CC}
Input Rise and Fall Time	
2V	1000ns (Max)
4.5V	500ns (Max)
6V	400ns (Max)

CAUTION: Stresses above those listed in "Absolute Maximum Ratings" may cause permanent damage to the device. This is a stress only rating and operation of the device at these or any other conditions above those indicated in the operational sections of this specification is not implied.

NOTES:

- In certain applications, the external load-resistor current may include both V_{CC} and signal-line components. To avoid drawing V_{CC} current when switch current flows into the transmission gate inputs, (terminals 1, 4, 8 and 11) the voltage drop across the bidirectional switch must not exceed 0.6V (calculated from R_{ON} values shown in the DC Electrical Specifications Table). No V_{CC} current will flow through R_L if the switch current flows into terminals 2, 3, 9 and 10.
- θ_{JA} is measured with the component mounted on an evaluation PC board in free air.

DC Electrical Specifications

PARAMETER	SYMBOL	TEST CONDITIONS		V_{CC} (V)	25 $^{\circ}C$			-40 $^{\circ}C$ TO 85 $^{\circ}C$		-55 $^{\circ}C$ TO 125 $^{\circ}C$		UNITS
		V_I (V)	V_{IS} (V)		MIN	TYP	MAX	MIN	MAX	MIN	MAX	
HC TYPES												
High Level Input Voltage	V_{IH}	-	-	2	1.5	-	-	1.5	-	1.5	-	V
				4.5	3.15	-	-	3.15	-	3.15	-	V
				9	6.3	-	-	6.3	-	6.3	-	V
Low Level Input Voltage	V_{IL}	-	-	2	-	-	0.5	-	0.5	-	0.5	V
				4.5	-	-	1.35	-	1.35	-	1.35	V
				9	-	-	2.7	-	2.7	-	2.7	V
Input Leakage Current (Any Control)	I_{IL}	V_{CC} or GND	-	10	-	-	± 0.1	-	± 1	-	± 1	μA
Off-Switch Leakage Current	I_Z	V_{IL}	V_{CC} or GND	10	-	-	± 0.1	-	± 1	-	± 1	μA

CD74HC4066, CD74HCT4066

DC Electrical Specifications (Continued)

PARAMETER	SYMBOL	TEST CONDITIONS		V _{CC} (V)	25°C			-40°C TO 85°C		-55°C TO 125°C		UNITS
		V _I (V)	V _{IS} (V)		MIN	TYP	MAX	MIN	MAX	MIN	MAX	
"ON" Resistance I _O = 1mA (Figure 1)	R _{ON}	V _{CC}	V _{CC} or GND	4.5	-	25	80	-	106	-	128	Ω
				6	-	20	75	-	94	-	113	Ω
				9	-	15	60	-	78	-	95	Ω
		V _{CC} to GND	4.5	-	35	95	-	118	-	142	Ω	
			6	-	24	84	-	105	-	126	Ω	
			9	-	16	70	-	88	-	105	Ω	
"ON" Resistance Between Any Two Switches	ΔR _{ON}	V _{CC}	-	4.5	-	1	-	-	-	-	-	Ω
				6	-	0.75	-	-	-	-	-	Ω
				9	-	0.5	-	-	-	-	-	Ω
Quiescent Device Current	I _{CC}	V _{CC} or GND	-	6	-	-	2	-	20	-	40	μA
				10	-	-	16	-	160	-	320	μA
HCT TYPES												
High Level Input Voltage	V _{IH}	-	-	4.5 to 5.5	2	-	-	2	-	2	-	V
Low Level Input Voltage	V _{IL}	-	-	4.5 to 5.5	-	-	0.8	-	0.8	-	0.8	V
Input Leakage Current (Any Control)	I _{IL}	V _{CC} or GND	-	5.5	-	-	±0.1	-	±1	-	±1	μA
Off-Switch Leakage Current	I _Z	V _{IL}	V _{CC} or GND	5.5	-	-	±0.1	-	±1	-	±1	μA
"ON" Resistance I _O = 1mA (Figure 1)	R _{ON}	V _{CC}	V _{CC} or GND	4.5	-	25	80	-	106	-	128	Ω
			V _{CC} to GND	4.5	-	35	95	-	118	-	142	Ω
"ON" Resistance Between Any Two Switches	ΔR _{ON}	V _{CC}	-	4.5	-	1	-	-	-	-	-	Ω
Quiescent Device Current	I _{CC}	V _{CC} or GND	-	5.5	-	-	2	-	20	-	40	μA
Additional Quiescent Device Current Per Input Pin: 1 Unit Load (Note 5)	ΔI _{CC}	V _{CC} - 2.1	-	4.5 to 5.5	-	100	360	-	450	-	490	μA

NOTE:

5. For dual-supply systems theoretical worst case (V_I = 2.4V, V_{CC} = 5.5V) specification is 1.8mA.

HCT Input Loading Table

INPUT	UNIT LOADS
All	1

NOTE: Unit Load is ΔI_{CC} limit specified in DC Electrical Specifications table, e.g., 360μA max at 25°C.

CD74HC4066, CD74HCT4066

Switching Specifications Input t_r , $t_f = 6\text{ns}$

PARAMETER	SYMBOL	TEST CONDITIONS	V_{CC} (V)	25°C			-40°C TO 85°C		-55°C TO 125°C		UNITS
				MIN	TYP	MAX	MIN	MAX	MIN	MAX	
HC TYPES											
Propagation Delay Time Switch In to Out	t_{PLH} , t_{PHL}	$C_L = 50\text{pF}$	2	-	-	60	-	75	-	90	ns
			4.5	-	-	12	-	15	-	18	ns
			9	-	-	8	-	11	-	13	ns
		$C_L = 15\text{pF}$	5	-	4	-	-	-	-	-	ns
Propagation Delay Time Switch Turn On Delay	t_{PZH} , t_{PZL}	$C_L = 50\text{pF}$	2	-	-	100	-	125	-	150	ns
			4.5	-	-	20	-	25	-	30	ns
			9	-	-	12	-	15	-	18	ns
		$C_L = 15\text{pF}$	5	-	8	-	-	-	-	-	ns
Propagation Delay Time Switch Turn Off Delay	t_{PHZ} , t_{PLZ}	$C_L = 50\text{pF}$	2	-	-	150	-	190	-	225	ns
			4.5	-	-	30	-	38	-	45	ns
			9	-	-	24	-	30	-	36	ns
		$C_L = 15\text{pF}$	5	-	12	-	-	-	-	-	ns
Input (Control) Capacitance	C_I	-	-	-	10	-	10	-	10	pF	
Power Dissipation Capacitance (Notes 6, 7)	C_{PD}	-	5	-	25	-	-	-	-	pF	
HCT TYPES											
Propagation Delay Time Switch In to Out	t_{PLH} , t_{PHL}	$C_L = 50\text{pF}$	4.5	-	-	12	-	15	-	18	ns
		$C_L = 15\text{pF}$	5	-	4	-	-	-	-	-	ns
Propagation Delay Time Switch Turn On Delay	t_{PZH} , t_{PZL}	$C_L = 50\text{pF}$	4.5	-	-	24	-	30	-	36	ns
		$C_L = 15\text{pF}$	5	-	9	-	-	-	-	-	ns
Propagation Delay Time Switch Turn Off Delay	t_{PHZ} , t_{PLZ}	$C_L = 50\text{pF}$	4.5	-	-	35	-	44	-	53	ns
		$C_L = 15\text{pF}$	5	-	14	-	-	-	-	-	ns
Input (Control) Capacitance	C_I	-	-	-	10	-	10	-	10	pF	
Power Dissipation Capacitance (Notes 6, 7)	C_{PD}	-	5	-	38	-	-	-	-	pF	

NOTES:

6. C_{PD} is used to determine the dynamic power consumption, per package.

7. $P_D = C_{PD} V_{CC}^2 f_i + \sum (C_L + C_S) V_{CC}^2 f_o$ where f_i = input frequency, f_o = output frequency, C_L = output load capacitance, C_S = switch capacitance, V_{CC} = supply voltage.

Analog Channel Specifications $T_A = 25^\circ\text{C}$

PARAMETER	TEST CONDITIONS	V_{CC} (V)	CD74HC4066	CD74HCT4066	UNITS
Switch Frequency Response Bandwidth at -3dB Figure 2	Figure 5, Notes 8, 9	4.5	200	200	MHz
Cross Talk Between Any Two Switches Figure 3	Figure 4, Notes 9, 10	4.5	-72	-72	dB
Total Harmonic Distortion	Figure 6, 1kHz, $V_{IS} = 4V_{P-P}$	4.5	0.022	0.023	%
	Figure 6, 1kHz, $V_{IS} = 8V_{P-P}$	9	0.008	N/A	%

CD74HC4066, CD74HCT4066

Analog Channel Specifications $T_A = 25^\circ\text{C}$ (Continued)

PARAMETER	TEST CONDITIONS	V_{CC} (V)	CD74HC4066	CD74HCT4066	UNITS
Control to Switch Feedthrough Noise	Figure 7	4.5	200	130	mV
		9	550	N/A	mV
Switch "OFF" Signal Feedthrough Figure 3	Figure 8, Notes 9, 10	4.5	-72	-72	dB
Switch Input Capacitance, C_S		-	5	5	pF

NOTES:

8. Adjust input level for 0dBm at output, $f = 1\text{MHz}$.
9. V_{IS} is centered at $V_{CC}/2$.
10. Adjust input for 0dBm at V_{IS} .

Typical Performance Curves

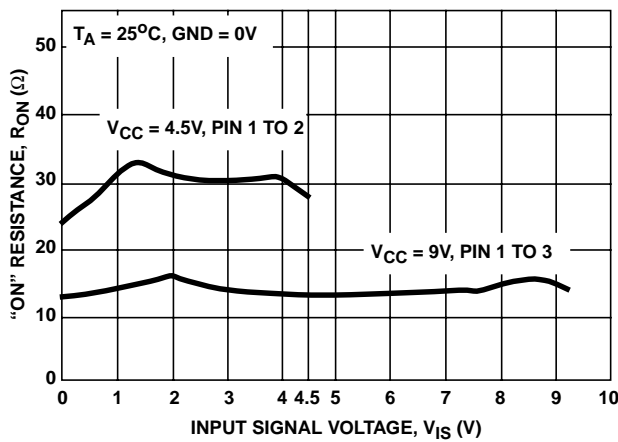

FIGURE 1. TYPICAL "ON" RESISTANCE vs INPUT SIGNAL VOLTAGE

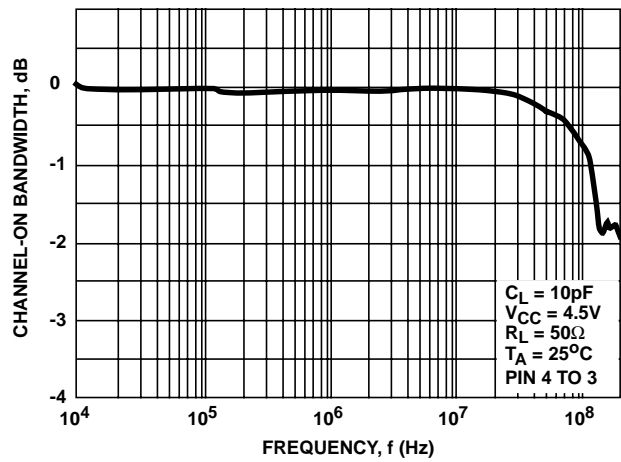

FIGURE 2. SWITCH FREQUENCY RESPONSE, $V_{CC} = 4.5\text{V}$

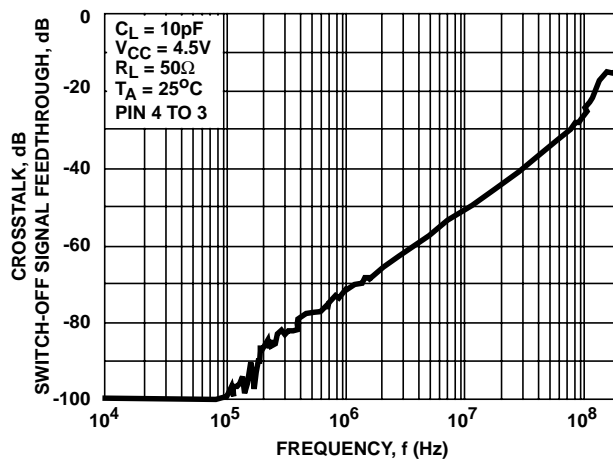

FIGURE 3. SWITCH-OFF SIGNAL FEEDTHROUGH AND CROSSTALK vs FREQUENCY, $V_{CC} = 4.5\text{V}$

Analog Test Circuits

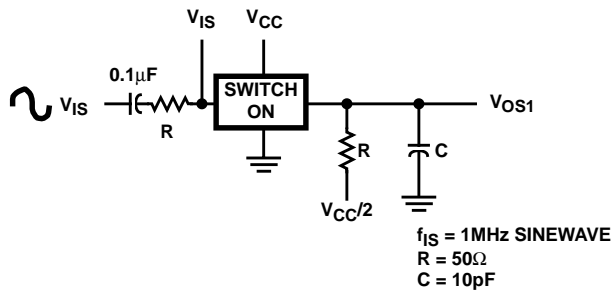

FIGURE 4. CROSTALK BETWEEN TWO SWITCHES TEST CIRCUIT

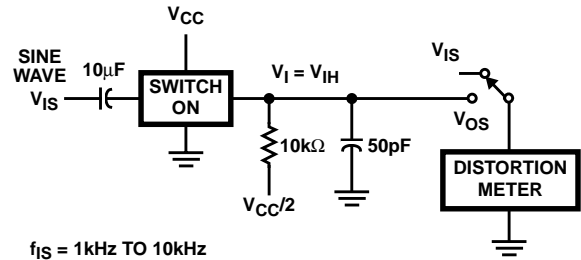
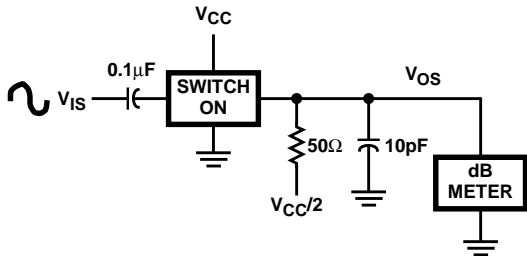

FIGURE 5. FREQUENCY RESPONSE TEST CIRCUIT

FIGURE 6. TOTAL HARMONIC DISTORTION TEST CIRCUIT

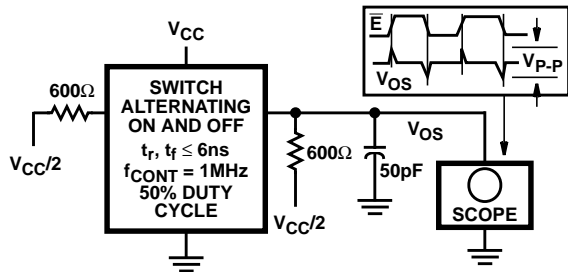

FIGURE 7. CONTROL-TO-SWITCH FEEDTHROUGH NOISE TEST CIRCUIT

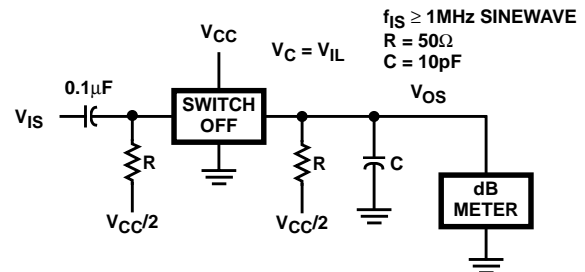

FIGURE 9. HC TRANSITION TIMES AND PROPAGATION DELAY TIMES, COMBINATION LOGIC

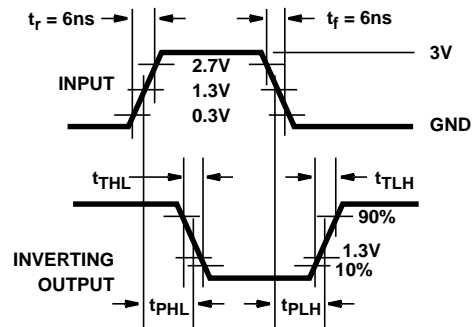

FIGURE 10. HCT TRANSITION TIMES AND PROPAGATION DELAY TIMES, COMBINATION LOGIC

Test Circuits and Waveforms

IMPORTANT NOTICE

Texas Instruments and its subsidiaries (TI) reserve the right to make changes to their products or to discontinue any product or service without notice, and advise customers to obtain the latest version of relevant information to verify, before placing orders, that information being relied on is current and complete. All products are sold subject to the terms and conditions of sale supplied at the time of order acknowledgement, including those pertaining to warranty, patent infringement, and limitation of liability.

TI warrants performance of its semiconductor products to the specifications applicable at the time of sale in accordance with TI's standard warranty. Testing and other quality control techniques are utilized to the extent TI deems necessary to support this warranty. Specific testing of all parameters of each device is not necessarily performed, except those mandated by government requirements.

CERTAIN APPLICATIONS USING SEMICONDUCTOR PRODUCTS MAY INVOLVE POTENTIAL RISKS OF DEATH, PERSONAL INJURY, OR SEVERE PROPERTY OR ENVIRONMENTAL DAMAGE ("CRITICAL APPLICATIONS"). TI SEMICONDUCTOR PRODUCTS ARE NOT DESIGNED, AUTHORIZED, OR WARRANTED TO BE SUITABLE FOR USE IN LIFE-SUPPORT DEVICES OR SYSTEMS OR OTHER CRITICAL APPLICATIONS. INCLUSION OF TI PRODUCTS IN SUCH APPLICATIONS IS UNDERSTOOD TO BE FULLY AT THE CUSTOMER'S RISK.

In order to minimize risks associated with the customer's applications, adequate design and operating safeguards must be provided by the customer to minimize inherent or procedural hazards.

TI assumes no liability for applications assistance or customer product design. TI does not warrant or represent that any license, either express or implied, is granted under any patent right, copyright, mask work right, or other intellectual property right of TI covering or relating to any combination, machine, or process in which such semiconductor products or services might be or are used. TI's publication of information regarding any third party's products or services does not constitute TI's approval, warranty or endorsement thereof.