

# Ceramic Filters (CERAFIL<sup>®</sup>) for FM Receivers

## CERAMIC FILTERS (CERAFIL<sup>®</sup>)

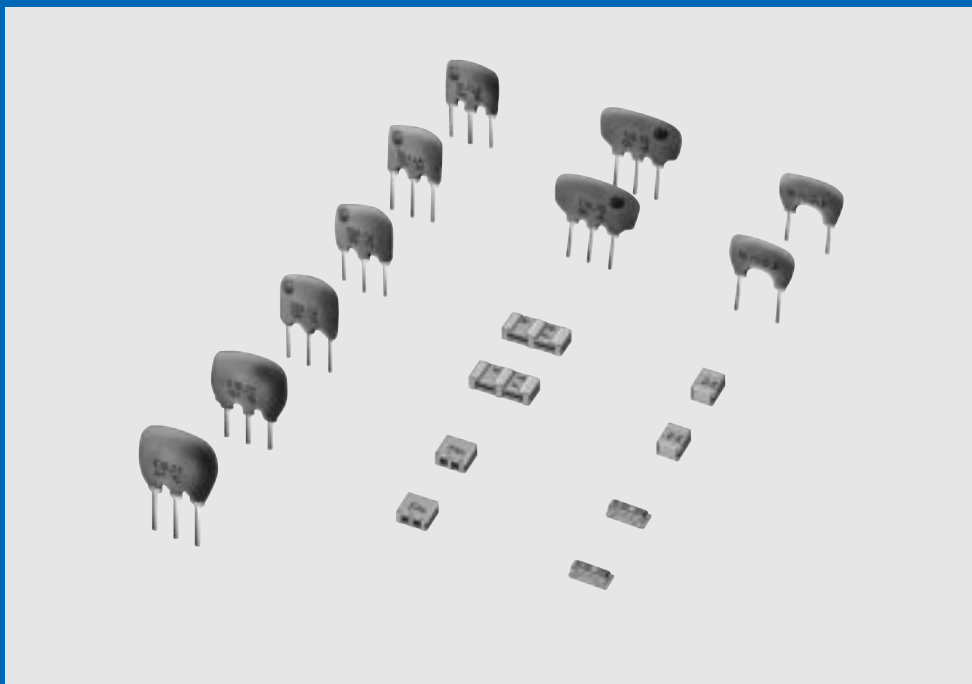

**muRata** *Innovator  
in Electronics*

Murata  
Manufacturing Co., Ltd.

Cat.No.P61E-7

# CONTENTS

CERAFIL® and "CERAFIL" in this catalog are the trademarks of Murata Manufacturing Co., Ltd.

<b>Part Numbering</b>	2
<b>1 CERAFIL® Chip Type SFECV Series</b>	3
● Chip CERAFIL® SFECV Series Notice	6
<b>2 CERAFIL® Small Chip Type SFECV Series</b>	7
● Chip CERAFIL® SFECV Series Notice	10
<b>3 CERAFIL® Standard Lead Type</b>	11
<b>4 CERAFIL® Low-loss Type</b>	14
<b>5 CERAFIL® Low-profile Type</b>	17
<b>6 CERAFIL® Lower Spurious Response Type</b>	20
<b>7 CERAFIL® Wider Band-width Type</b>	23
<b>8 CERAFIL® Narrow Band Type</b>	25
<b>9 CERAFIL® For FM -IF Tuners</b>	28
<b>10 CERAFIL® Three-Elements Type SFTLA Series</b>	33
<b>Lead Type CERAFIL® Test Circuit and Characteristics Data</b>	36
<b>Lead Type CERAFIL® Characteristics Data and Notice</b>	37
<b>11 Discriminators Chip Type CDACV Series</b>	38
● Chip Type Discriminators CDACV Series Notice	41
<b>12 Discriminators Chip Low-profile Type CDSCA Series</b>	42
● Chip Type Discriminators CDSCA Series Notice	44
<b>13 Discriminators CDALA Series</b>	45
● Lead Type Discriminators Notice	49
<b>Packaging</b>	50
<b>Test Circuit of Ceramic Discriminator</b>	53
<b>Example of Applied Circuit</b>	54

● **Part Numbering** (The structure of the "Global Part Numbers" that have been adopted since June 2001 and the meaning of each code are described herein.)  
 If you have any questions about details, inquire at your usual Murata sales office or distributor.

**CERAFIL<sup>®</sup> for FM**

(Global Part Number) 

SF	E	LA	10M7	FAA0	-R0
①	②	③	④	⑤	⑥

① Product ID

Product ID	
<b>SF</b>	Ceramic Filters

② Oscillation/Numbers of Element

Code	Oscillation/Numbers of Element
<b>E</b>	2 Elements Thickness Expander mode
<b>T</b>	3 Elements Thickness Expander mode
<b>K</b>	2 Elements Thickness Expander mode (2nd Harmonic)
<b>V</b>	2 Elements Thickness Expander mode (3rd Over Tone)

③ Structure/Size

Code	Structure/Size
<b>L</b> □	Lead Type
<b>C</b> □	Chip Type

□ is expressed "A" or subsequent code, which indicates the size.

④ Nominal Center Frequency

Expressed by four-digit alphanumerics. The unit is in hertz (MHz).  
 Decimal point is expressed by capital letter "M".

**Discriminators for FM**

(Global Part Number) 

CD	A	LA	10M7	GA	001	-R0
①	②	③	④	⑤	⑥	⑦

① Product ID

Product ID	
<b>CD</b>	Discriminators

② Oscillation

Code	Oscillation
<b>A</b>	Thickness Expander mode

③ Structure/Size

Code	Structure/Size
<b>L</b> □	Lead Type
<b>C</b> □	Chip Type

□ is expressed "A" or subsequent code, which indicates the size.

④ Nominal Center Frequency

Expressed by four-digit alphanumerics. The unit is in hertz (MHz).  
 Decimal point is expressed by capital letter "M".

⑤ Product Specification

Code	Product Specification
<b>FAA0</b>	Four-digit alphanumerics express pass-bandwidth, center frequency tolerance, rank, series, others.

⑥ Packaging

Code	Packaging
<b>-B0</b>	Bulk
<b>-R0</b>	Plastic Taping ø180mm
<b>-R1</b>	Plastic Taping ø330mm
<b>-A0</b>	1500pcs. /Radial Taping H <sub>0</sub> =18mm
<b>-A1</b>	1000pcs. /Radial Taping H <sub>0</sub> =18mm

Radial taping is applied to lead type and plastic taping to chip type.  
 With non-standard products, two-digit alphanumerics indicating "Individual Specification" is added between "⑤ Product Specification" and "⑥ Packaging".

⑤ Product Specification

Code	Product Specification
<b>GA</b>	Two-digit alphanumerics express type, center frequency, rank, others

⑥ IC

Code	IC
<b>001</b>	Applicable IC Control Code

⑦ Packaging

Code	Packaging
<b>-B0</b>	Bulk
<b>-A0</b>	Radial Taping H <sub>0</sub> =18mm
<b>-R0</b>	Plastic Taping (ø180mm)
<b>-R1</b>	Plastic Taping (ø330mm)

Radial taping is applied to lead type and plastic taping to chip type.  
 With non-standard products, an alphanumerics indicating "Individual Specification" is added between "⑥ IC" and "⑦ Packaging".

# Ceramic Filters (CERAFIL<sup>®</sup>) for FM Receivers



## CERAFIL<sup>®</sup> Chip Type SFECV Series

SFECV10M7 series for FM-receivers are monolithic type ceramic filters which utilize the energy trapped thickness vibration-mode of the piezoelectric ceramic. By taking advantage of the very low profile, new SFECV series and PFWCC(kHz filter for AM receiver) enable costumers to make AM/FM set so thin, and it can be of help to the total chip circuit.

### ■ Features

1. Super-thin. Only 1.5mm. The most suitable ceramic filter available for thinning substrates.
2. Heat resistant. Reflow soldering can be performed because of its excellent heat resistance.
3. Piezoelectric element is connected in the sandwich shape by heat resistant substrate, thus it has excellent mechanical strength, and it is suitable for automatic mounting.
4. Various bandwidths are available. Select a suitable type in accordance with the desired selectivity.
5. Electrical characteristics are the same as conventional "CERAFIL".

### ■ Applications

1. Small, thin radios
2. Automotive radios
3. Headphone stereos

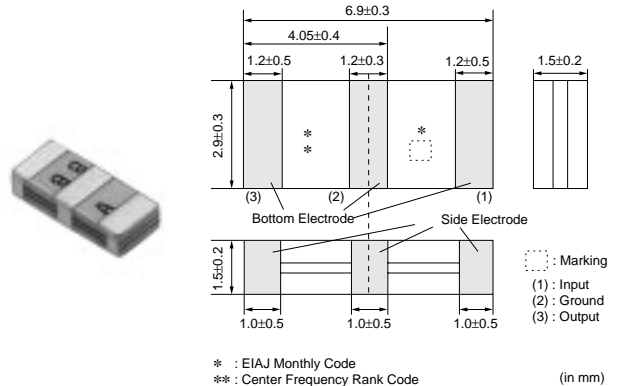

Part Number	Center Frequency (fo) (MHz)	3dB Bandwidth (kHz)	Attenuation (kHz)	Insertion Loss (dB)	Spurious Attenuation (dB)
SFECV10M7KA00-R0	10.700 ±30kHz	within110 ±30kHz	320 max.	within6.0 ±2.0dB	35 min.
SFECV10M7JA00-R0	10.700 ±30kHz	within150 ±40kHz	380 max.	10.0 max.	30 min.
SFECV10M7HA00-R0	10.700 ±30kHz	within180 ±40kHz	470 max.	within4.0 ±2.0 dB	35 min.
SFECV10M7GA00-R0	10.700 ±30kHz	within230 ±50kHz	510 max.	within3.5 ±2.0 dB	35 min.
SFECV10M7FA00-R0	10.700 ±30kHz	within280 ±50kHz	590 max.	within3.0 ±2.0 dB	35 min.

Area of Attenuation : [within 20dB]    Area of Spurious Attenuation : [within 9MHz to 12MHz]  
 Center frequency(fo) defined by the center of 3dB bandwidth.

### ■ Center Frequency Rank Code

CODE	30kHz Step	25kHz Step
D	10.64MHz±30kHz	10.650MHz±25kHz
B	10.67MHz±30kHz	10.675MHz±25kHz
A	10.70MHz±30kHz	10.700MHz±25kHz
C	10.73MHz±30kHz	10.725MHz±25kHz
E	10.76MHz±30kHz	10.750MHz±25kHz
Z	Combination A,B,C,D,E	
M	Combination A,B,C	

## Frequency Characteristics

SFECV10M7KA00-R0

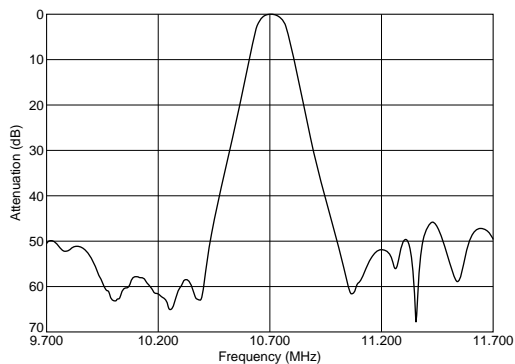

SFECV10M7JA00-R0

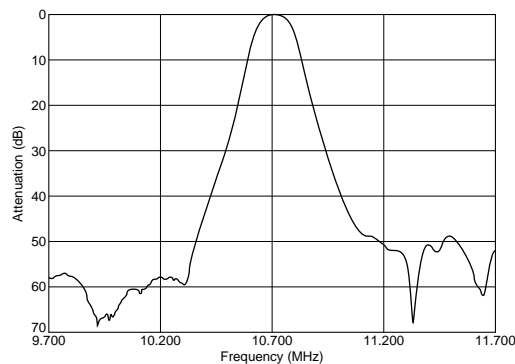

SFECV10M7HA00-R0

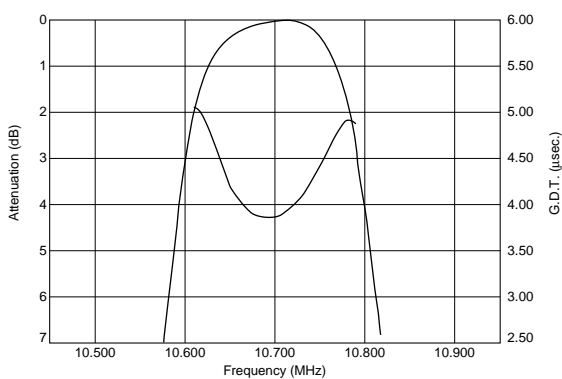

SFECV10M7GA00-R0

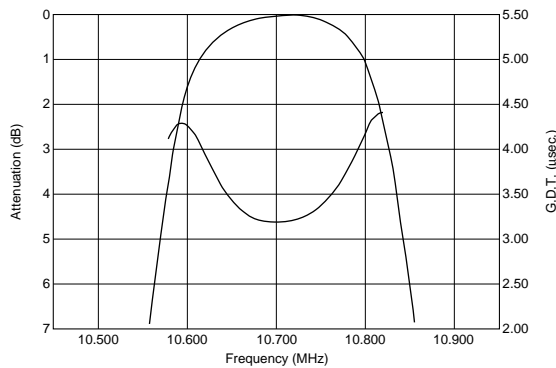

SFECV10M7FA00-R0

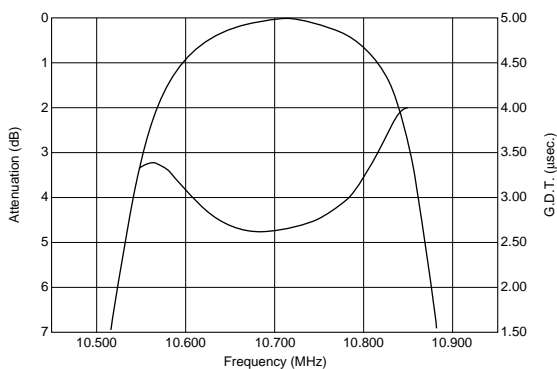

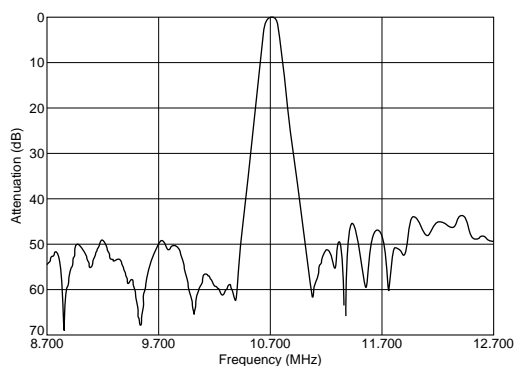

## Frequency Characteristics (Spurious)

SFECV10M7KA00-R0

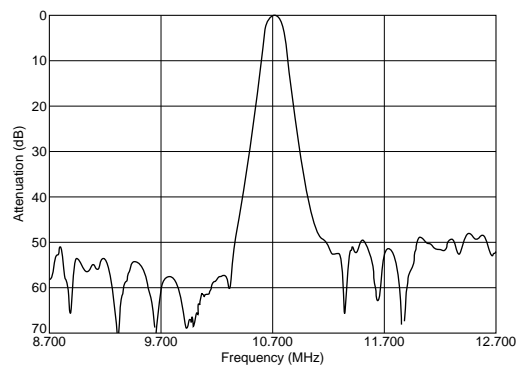

SFECV10M7JA00-R0



Continued on the following page. 

Continued from the preceding page.

## Frequency Characteristics (Spurious)

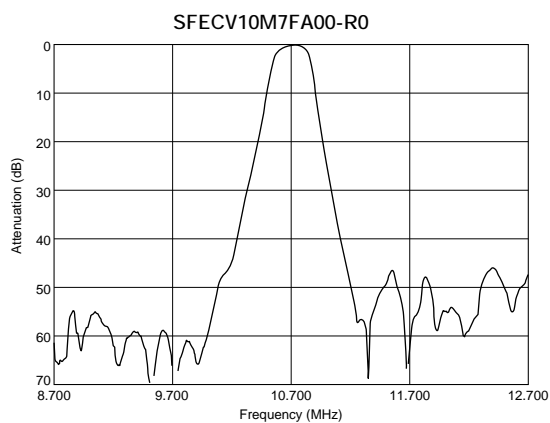
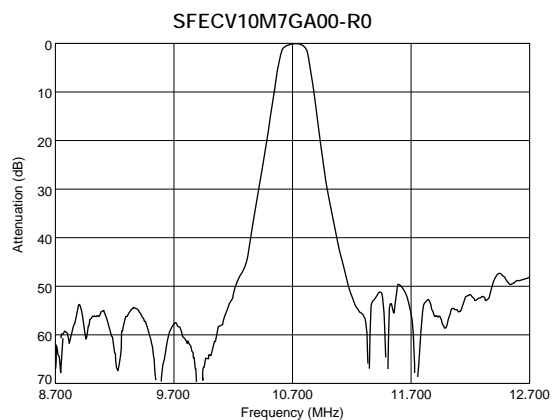
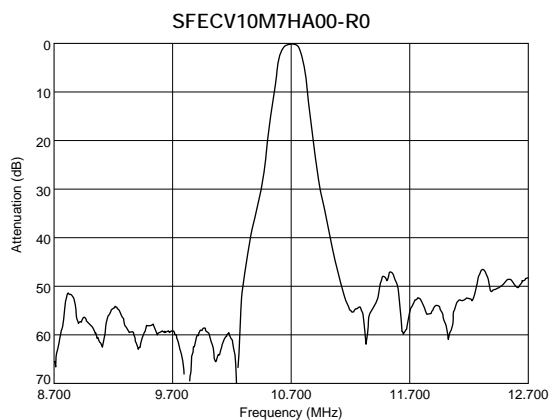

## Standard Land Pattern Dimensions

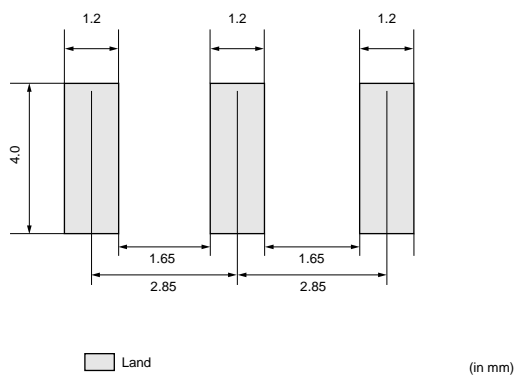

## Test Circuit

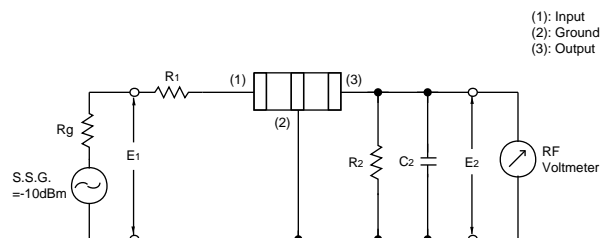

$R_g = 50\Omega$     $R_1 = 280\Omega \pm 5\%$     $R_2 = 330\Omega \pm 5\%$   
 $C_2 = 10 \pm 2 \text{ pF}$  (Including stray capacitance and Input capacitance of RF Volt Meter)  
 $E_1$ : S.S.G.   S.S.G. Output Voltage

# 1 Chip CERAFIL® SFECV Series Notice

## ■ Notice (Soldering and Mounting)

### 1. Standard Reflow Soldering Condition

#### (1) Reflow

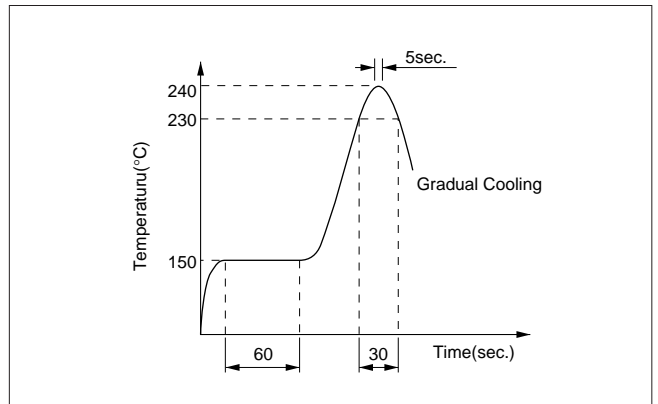

#### (2) Soldering Iron

Lead terminal is directly contacted with the tip of soldering iron of  $280 \pm 5^\circ\text{C}$  for  $3.0 \pm 0.5$  seconds.

### 2. Wash

The component cannot be withstand washing.

## ■ Notice (Handling)

1. The component will be damaged when an excessive stress is applied.
2. The component may be damaged if excess mechanical stress is applied to it mounted on the printed circuit board.
3. Design layout of components on the PC board to minimize the stress imposed on the warp or flexure of the board.
4. After installing chips, if solder is excessively applied to the circuit board, mechanical stress will cause destruction resistance characteristics to lower. To prevent this, be extremely careful in determining shape and dimension before designing the circuit board diagram.
5. When the positioning claws and pick up nozzle are worn, the load is applied to the chip while positioning is concentrated to one positioning accuracy, etc. Careful checking and maintenance are necessary to prevent unexpected trouble.
6. When correcting chips with a soldering iron, the tip of the soldering iron should not directly touch the chip component. Depending on the soldering conditions, the effective area of terminations may be reduced. the use of solder containing Ag should be done to prevent the electrode erosion.
7. Do not clean or wash the component as it is not hermetically sealed.
8. In case of covering filter with over coat, conditions such as material of resin, cure temperature, and so on should be evaluated well.
9. Do not use strong acidity flux, more than 0.2wt% chlorine content, in re-flow soldering.
10. Accurate test circuit values are required to measure electrical characteristics. It may be a cause of mis-correlation if there is any deviation, especially stray capacitance, from the test circuit in the specification.

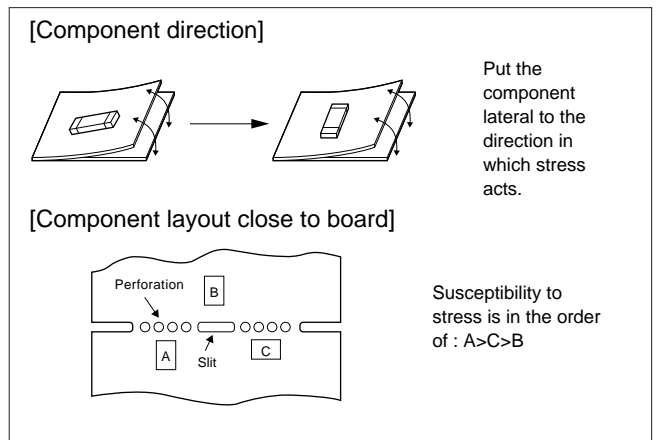

# Ceramic Filters (CERAFIL<sup>®</sup>) for FM Receivers



## CERAFIL<sup>®</sup> Small Chip Type SF ECS Series

SF ECS10M7 series for FM-receivers are small, high performance and super thin (1.4mm) filters.

Piezoelectric element is connected in the sandwich shape by ceramics substrate.

They have 1.4mm thickness and small mounting area. (3.5x3.1mm)

New SF ECS series and PFWCC(kHz filter for AM receiver) enable customers to make AM/FM set so thin and small sized.

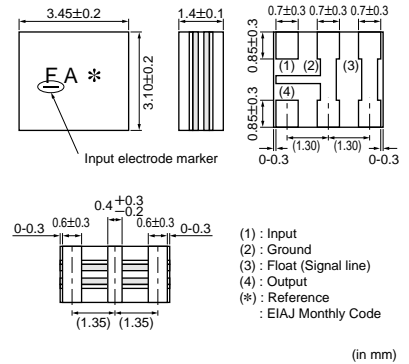
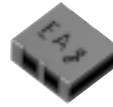

### ■ Features

1. The filters are mountable by automatic placers.
2. They are slim, at only 1.4mm thickness, and have a small mounting area (3.5x3.1mm) enabling flexible PCB design.
3. Various bandwidths are available. Select a suitable type in accordance with the desires selectivity.
4. Operating temperature range :  
-20 to +80 (degree C)  
Storage temperature range :  
-40 to +85 (degree C)

### ■ Applications

1. Small, thin radios
2. Headphone stereos

Part Number	Center Frequency (fo) (MHz)	3dB Bandwidth (kHz)	Attenuation (kHz)	Insertion Loss (dB)	Spurious Attenuation (dB)
<b>SF ECS10M7HA00-R0</b>	10.700 ±30kHz	within180 ±40kHz	470 max.	within4.5 ±2.0 dB	30 min.
<b>SF ECS10M7GA00-R0</b>	10.700 ±30kHz	within230 ±50kHz	510 max.	within3.5 ±2.0 dB	30 min.
<b>SF ECS10M7FA00-R0</b>	10.700 ±30kHz	within280 ±50kHz	590 max.	within3.0 ±2.0 dB	30 min.

Area of Attenuation : [within 20dB] Area of Spurious Attenuation : [within 9MHz to 12MHz]  
Center frequency(fo) defined by the center of 3dB bandwidth.

### ■ Center Frequency Rank Code

CODE	30kHz Step	25kHz Step
<b>D</b>	10.64MHz±30kHz	10.650MHz±25kHz
<b>B</b>	10.67MHz±30kHz	10.675MHz±25kHz
<b>A</b>	10.70MHz±30kHz	10.700MHz±25kHz
<b>C</b>	10.73MHz±30kHz	10.725MHz±25kHz
<b>E</b>	10.76MHz±30kHz	10.750MHz±25kHz
<b>Z</b>	Combination A,B,C,D,E	
<b>M</b>	Combination A,B,C	



## Frequency Characteristics

2

SF ECS10M7HA00-R0

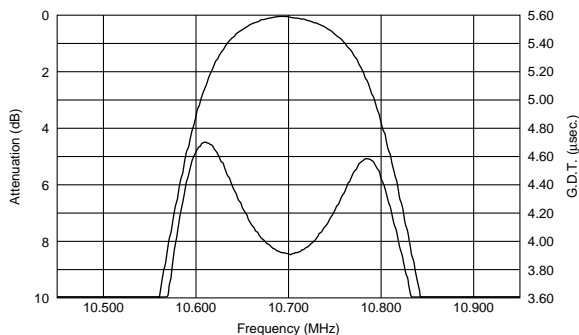

SF ECS10M7GA00-R0

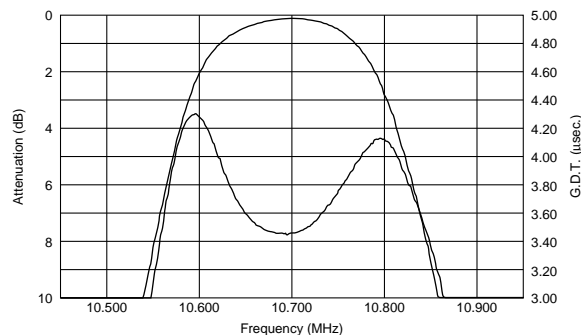

SF ECS10M7FA00-R0

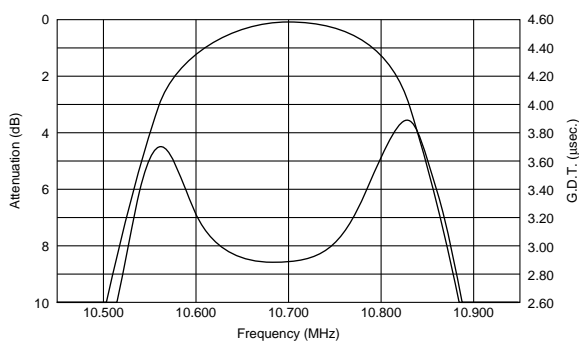

## Frequency Characteristics (Spurious)

SF ECS10M7HA00-R0

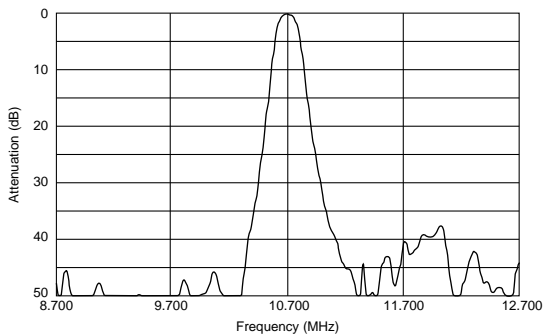

SF ECS10M7GA00-R0

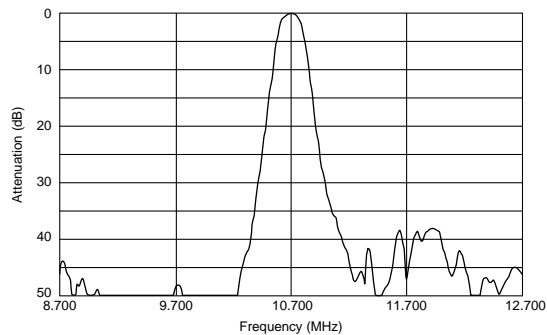

SF ECS10M7FA00-R0

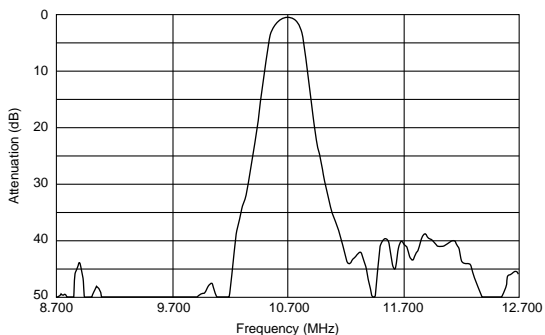

### Standard Land Pattern Dimensions

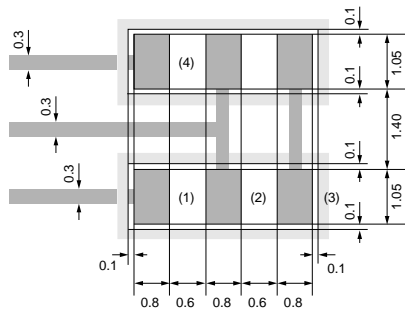

(1) : Input (2) : Ground (3) : Float Signal Line (4) : Out put  
 It shows solder resist land pattern.

(in mm)

### Test Circuit

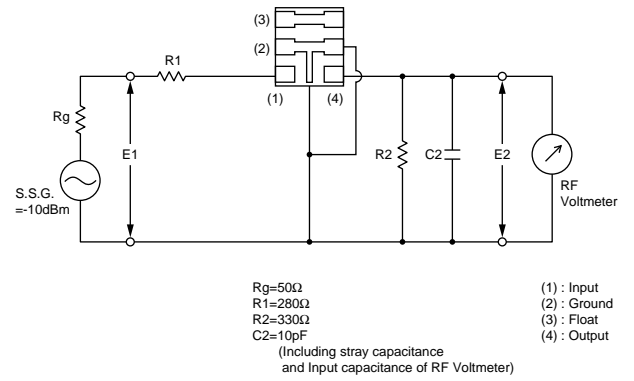

$R_g=50\Omega$   
 $R_1=280\Omega$   
 $R_2=330\Omega$   
 $C_2=10pF$   
 (Including stray capacitance and Input capacitance of RF Voltmeter)

(1) : Input  
 (2) : Ground  
 (3) : Float  
 (4) : Output

## Chip CERAFIL® SFECS Series Notice

2

### ■ Notice (Soldering and Mounting)

#### 1. Standard Reflow Soldering Condition

##### (1) Reflow

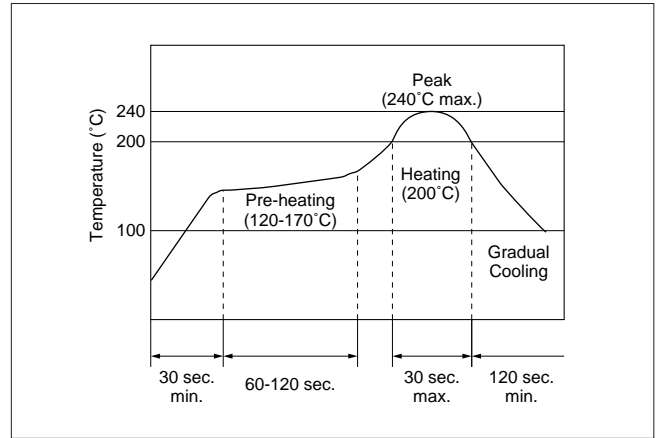

##### (2) Soldering Iron

Filter shall be soldered at  $280 \pm 5^\circ\text{C}$  for  $3.0 \pm 0.5$  seconds.

The soldering iron shall not touch the filter white soldering.

#### 2. Wash

The component cannot be withstand washing.

### ■ Notice (Handling)

1. The component will be damaged when an excessive stress is applied.
2. The component may be damaged if excess mechanical stress is applied to it mounted on the printed circuit board.
3. Design layout of components on the PC board to minimize the stress imposed on the warp or flexure of the board.
4. After installing chips, if solder is excessively applied to the circuit board, mechanical stress will cause destruction resistance characteristics to lower. To prevent this, be extremely careful in determining shape and dimension before designing the circuit board diagram.
5. When the positioning claws and pick up nozzle are worn, the load is applied to the chip while positioning is concentrated to one positioning accuracy, etc. Careful checking and maintenance are necessary to prevent unexpected trouble.
6. When correcting chips with a soldering iron, the tip of the soldering iron should not directly touch the chip component. Depending on the soldering conditions, the effective area of terminations may be reduced. The use of solder containing Ag should be done to prevent the electrode erosion.
7. Do not clean or wash the component as it is not hermetically sealed.
8. In case of covering filter with over coat, conditions such as material of resin, cure temperature, and so on should be evaluated well.
9. Do not use strong acidity flux, more than 0.2wt% chlorine content, in re-flow soldering.
10. Accurate test circuit values are required to measure electrical characteristics.  
It may be a cause of mis-correlation if there is any deviation, especially stray capacitance, from the test circuit in the specification.

#### [Component layout close to board]

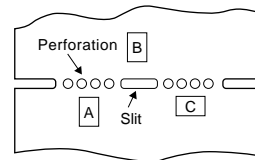

Susceptibility to stress is in the order of : A>C>B

# Ceramic Filters (CERAFIL<sup>®</sup>) for FM Receivers



## CERAFIL<sup>®</sup> Standard Lead Type

SFELA10M7 series for FM-receivers are monolithic type ceramic filters which use the energy trapped thickness vibration-mode of the piezoelectric ceramic.

### ■ Features

1. These miniature filters have high mechanical strength.
2. Low loss, favorable waveform symmetry, and high selectivity.
3. Various band widths are available for applications in wide to narrow bands.
4. Small dispersion and stable characteristics.
5. Change in center frequency is typically within  $\pm 30\text{ppm}/(\text{degree C})$  at  $-20$  to  $+80$  (degree C).
6. High reliability.



SFELA10M7HA00-B0

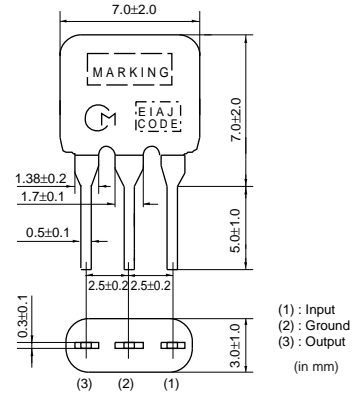

SFELA10M7GA00-B0

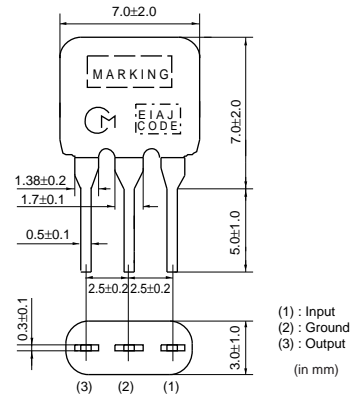

SFELA10M7FA00-B0

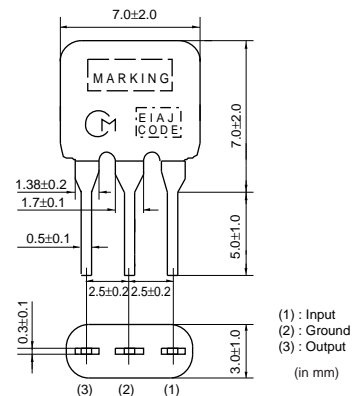

Part Number	Center Frequency (fo) (MHz)	3dB Bandwidth (kHz)	Attenuation (kHz)	Insertion Loss (dB)	Spurious Attenuation (dB)
SFELA10M7HA00-B0	10.700 ±30kHz	within 180 ±40kHz	520 max.	7.0 max.	40 min.
SFELA10M7GA00-B0	10.700 ±30kHz	within 230 ±50kHz	570 max.	within 4.0 ±2.0dB	40 min.
SFELA10M7FA00-B0	10.700 ±30kHz	within 280 ±50kHz	650 max.	within 4.0 ±2.0dB	30 min.

Area of Attenuation : [within 20dB] Area of Spurious Attenuation : [within 9MHz to 12MHz]  
Center frequency(fo) defined by the center of 3dB bandwidth.

**Center Frequency Rank Code**

CODE	30kHz Step	25kHz Step
<b>D</b>	10.64MHz±30kHz	10.650MHz±25kHz
<b>B</b>	10.67MHz±30kHz	10.675MHz±25kHz
<b>A</b>	10.70MHz±30kHz	10.700MHz±25kHz
<b>C</b>	10.73MHz±30kHz	10.725MHz±25kHz
<b>E</b>	10.76MHz±30kHz	10.750MHz±25kHz
<b>Z</b>	Combination A,B,C,D,E	
<b>M</b>	Combination A,B,C	

**Frequency Characteristics**

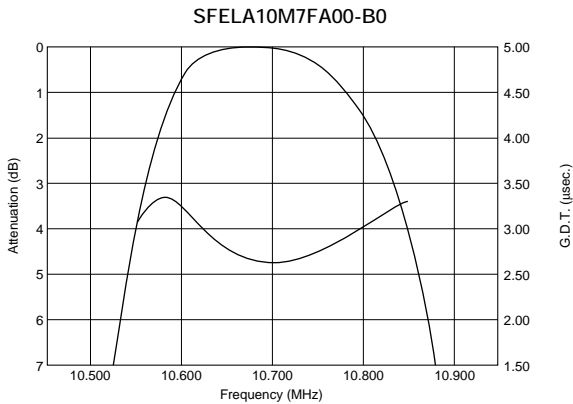
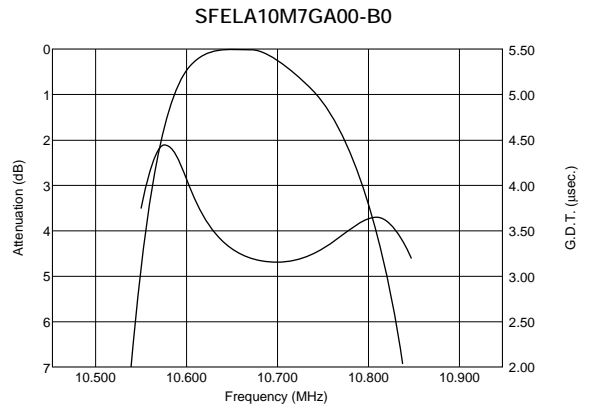
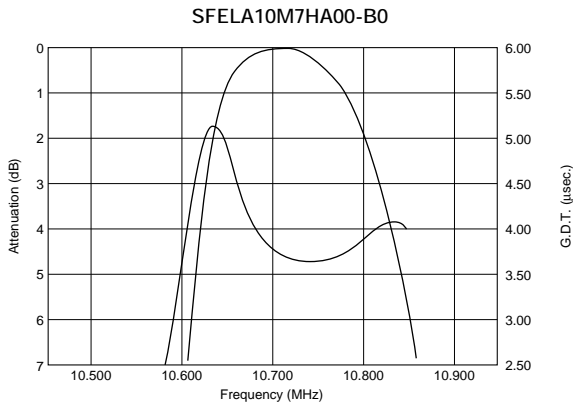

**Frequency Characteristics (Spurious)**

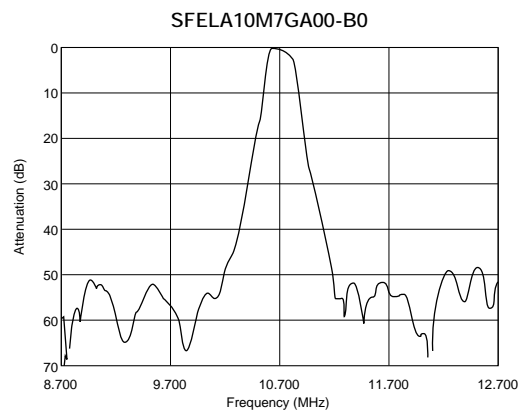
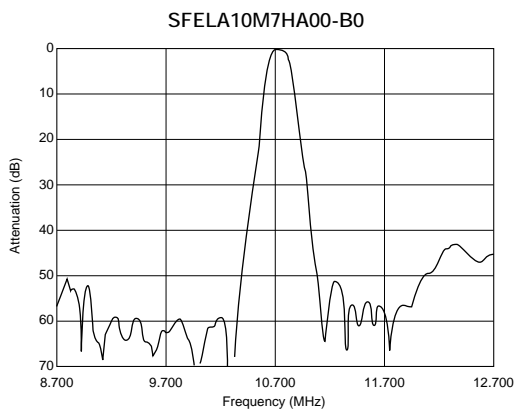

Continued on the following page.

Continued from the preceding page.

### Frequency Characteristics (Spurious)

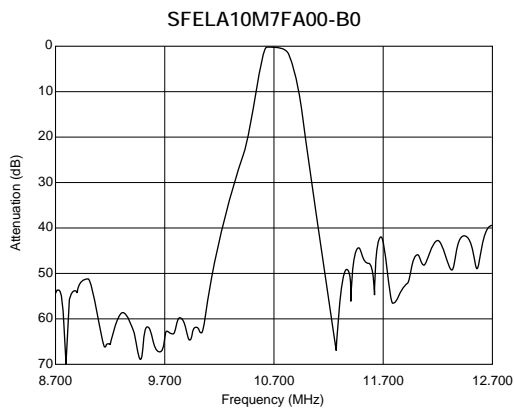

### Spurious Response

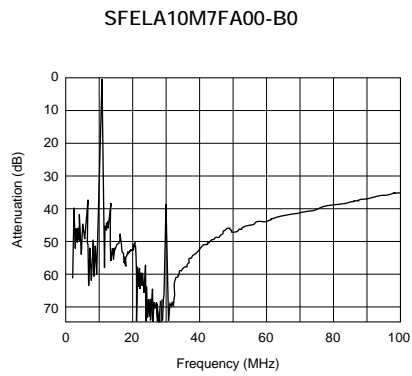

# Ceramic Filters (CERAFIL<sup>®</sup>) for FM Receivers



## CERAFIL<sup>®</sup> Low-loss Type

SFELA10M7 series for FM-receivers are monolithic type ceramic filters which use the energy trapped thickness vibration-mode of the piezoelectric ceramic.

4

### ■ Features

1. Insertion loss is 1 to 1.5dB lower than conventional products. This types are useful for elevating the sensitivity of sets.
2. Small dispersion and stable characteristics.
3. Excellent shape factor of frequency response.
4. Good waveform symmetry.



SFELA\_JAA0-B0

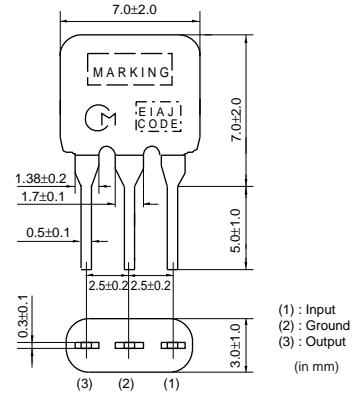

SFELA\_HAA0-B0

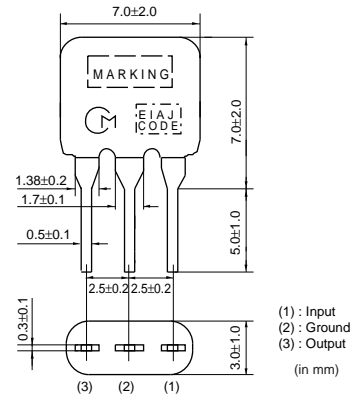

SFELA\_GAA0-B0

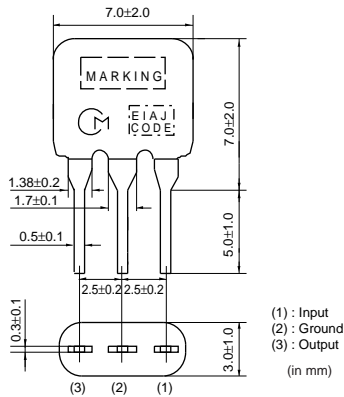

SFELA\_FAA0-B0

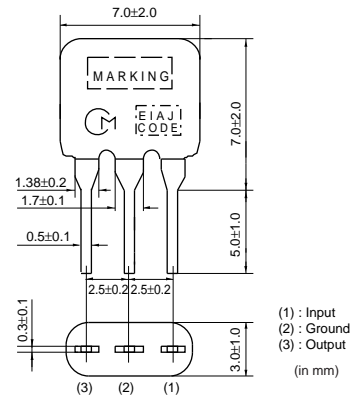

Part Number	Center Frequency (fo) (MHz)	3dB Bandwidth (kHz)	Attenuation (kHz)	Insertion Loss (dB)	Spurious Attenuation (dB)
SFELA10M7JAA0-B0	10.700 ±30kHz	within150 ±40kHz	360 max.	within4.5 ±2.0dB	35 min.
SFELA10M7HAA0-B0	10.700 ±30kHz	within180 ±40kHz	470 max.	within3.5 ±1.5dB	35 min.
SFELA10M7GAA0-B0	10.700 ±30kHz	within230 ±50kHz	520 max.	within3.0 ±2.0dB	35 min.
SFELA10M7FAA0-B0	10.700 ±30kHz	within280 ±50kHz	590 max.	within2.5 ±2.0dB	30 min.

Area of Attenuation : [within 20dB] Area of Spurious Attenuation : [within 9MHz to 12MHz]  
Center frequency(fo) defined by the center of 3dB bandwidth.

### Center Frequency Rank Code

CODE	30kHz Step	25kHz Step
D	10.64MHz±30kHz	10.650MHz±25kHz
B	10.67MHz±30kHz	10.675MHz±25kHz
A	10.70MHz±30kHz	10.700MHz±25kHz
C	10.73MHz±30kHz	10.725MHz±25kHz
E	10.76MHz±30kHz	10.750MHz±25kHz
Z	Combination A,B,C,D,E	
M	Combination A,B,C	

### Frequency Characteristics

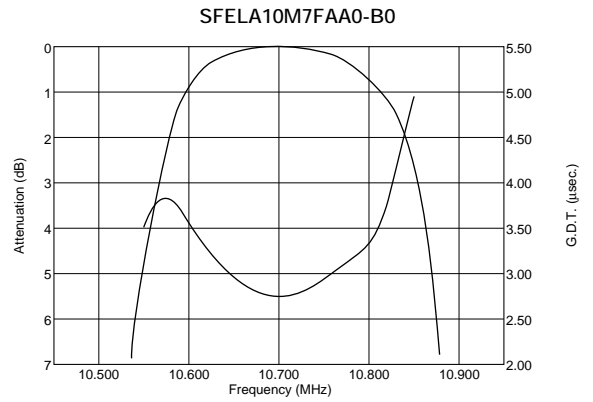
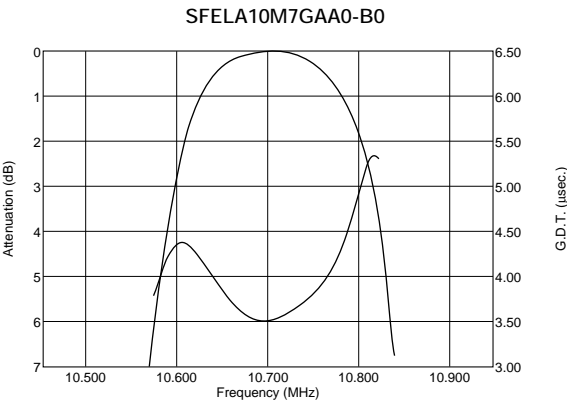
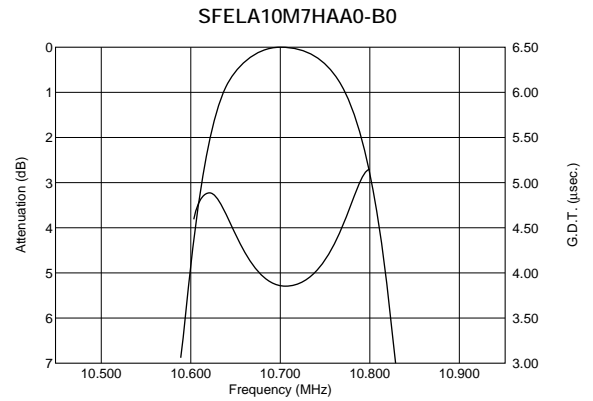
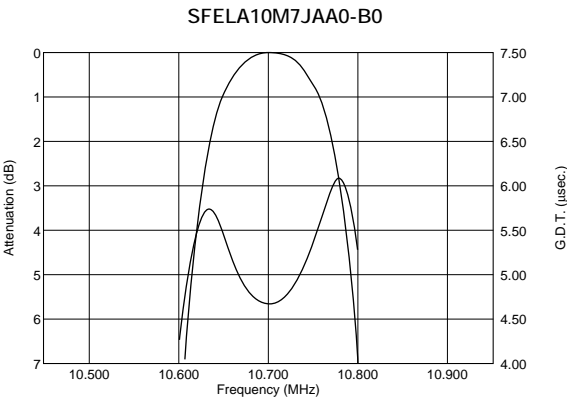

### Frequency Characteristics (Spurious)

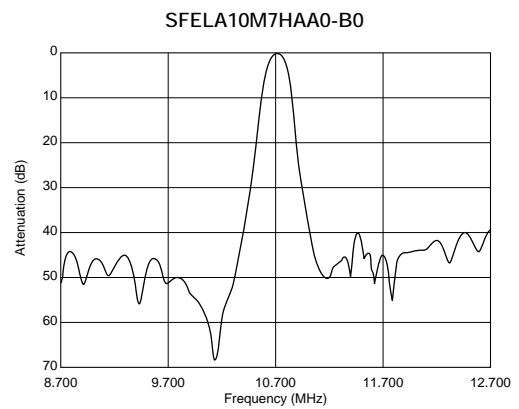
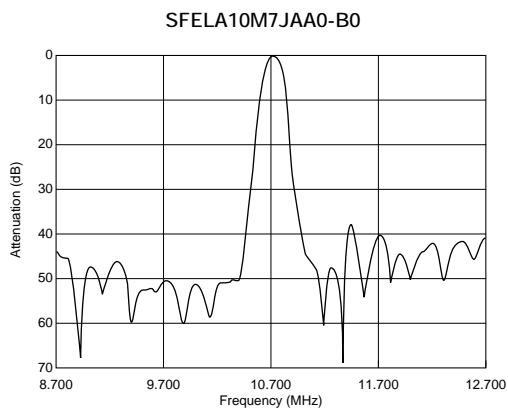

Continued on the following page.



Continued from the preceding page.

### Frequency Characteristics (Spurious)

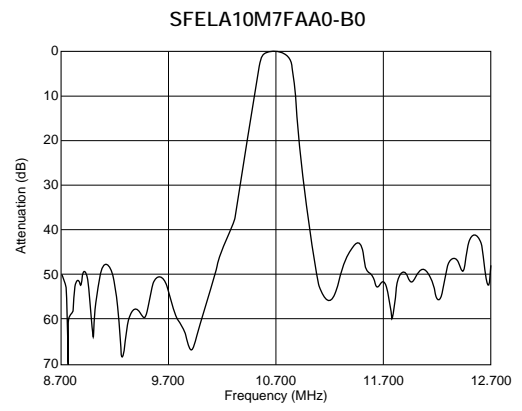
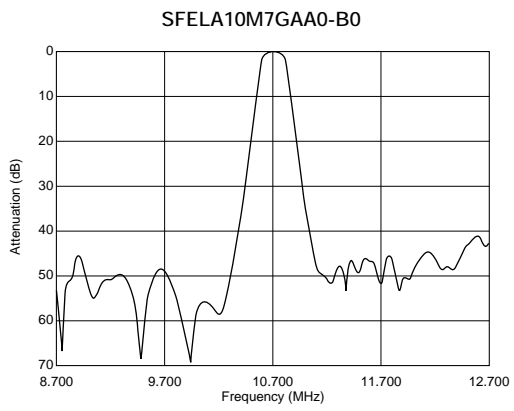

# Ceramic Filters (CERAFIL<sup>®</sup>) for FM Receivers



## CERAFIL<sup>®</sup> Low-profile Type

SFELB10M7 series for FM-receivers are monolithic type ceramic filters which use the energy trapped thickness vibration-mode of the piezoelectric ceramic.

### ■ Features

1. Installed height is 5 mm, making it well suited for compact, thin sets.
2. Environmental reliability is the same as those of the ceramic filter SFELA10M7 series.



SFELB10M7KA00-B0

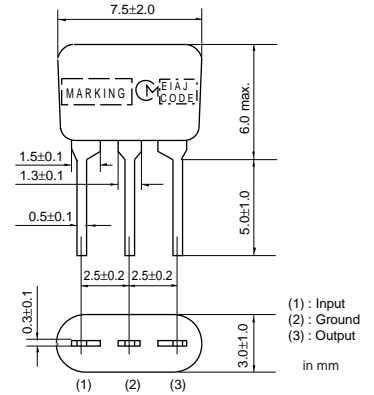

SFELB10M7JA00-B0

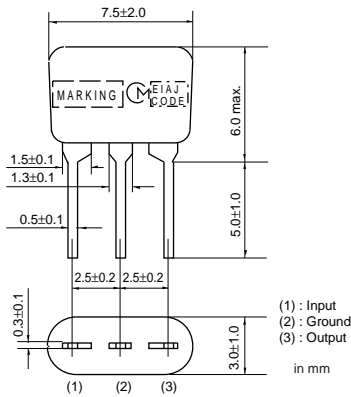

SFELB10M7HA00-B0

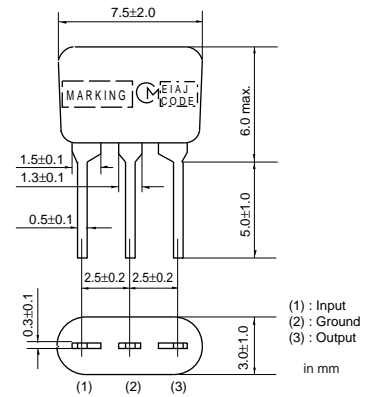

SFELB10M7GA00-B0

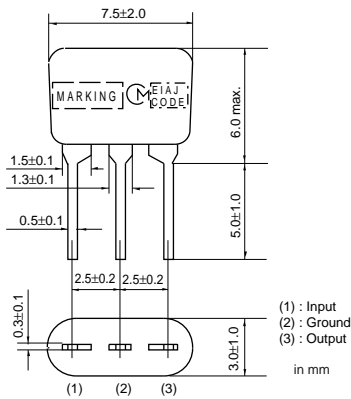

SFELB10M7FA00-B0

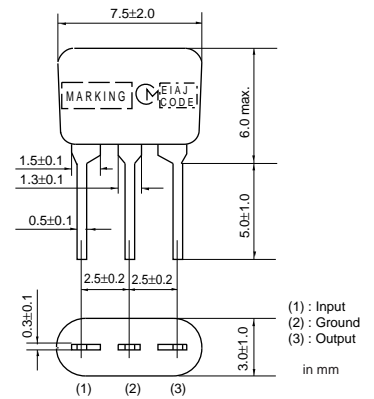

Part Number	Center Frequency (fo) (MHz)	3dB Bandwidth (kHz)	Attenuation (kHz)	Insertion Loss (dB)	Spurious Attenuation (dB)
SFELB10M7KA00-B0	10.700 ±30kHz	within110 ±30kHz	350 max.	within7.0 ±2.0dB	30 min.
SFELB10M7JA00-B0	10.700 ±30kHz	within150 ±40kHz	360 max.	within4.5 ±2.0dB	35 min.
SFELB10M7HA00-B0	10.700 ±30kHz	within180 ±40kHz	470 max.	within3.5 ±2.0dB	35 min.
SFELB10M7GA00-B0	10.700 ±30kHz	within230 ±50kHz	570 max.	within3.0 ±2.0dB	40 min.
SFELB10M7FA00-B0	10.700 ±30kHz	within280 ±50kHz	650 max.	within3.0 ±2.0dB	30 min.

Area of Attenuation : [within 20dB] Area of Spurious Attenuation : [within 9MHz to 12MHz]  
Center frequency(fo) defined by the center of 3dB bandwidth.

### Center Frequency Rank Code

CODE	30kHz Step	25kHz Step
<b>D</b>	10.64MHz±30kHz	10.650MHz±25kHz
<b>B</b>	10.67MHz±30kHz	10.675MHz±25kHz
<b>A</b>	10.70MHz±30kHz	10.700MHz±25kHz
<b>C</b>	10.73MHz±30kHz	10.725MHz±25kHz
<b>E</b>	10.76MHz±30kHz	10.750MHz±25kHz
<b>Z</b>	Combination A,B,C,D,E	
<b>M</b>	Combination A,B,C	

### Frequency Characteristics

5

SFELB10M7KA00-B0

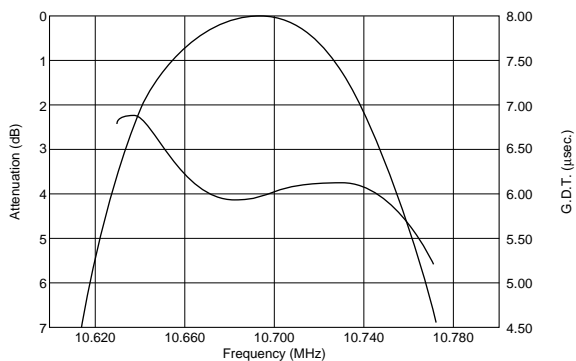

SFELB10M7JA00-B0

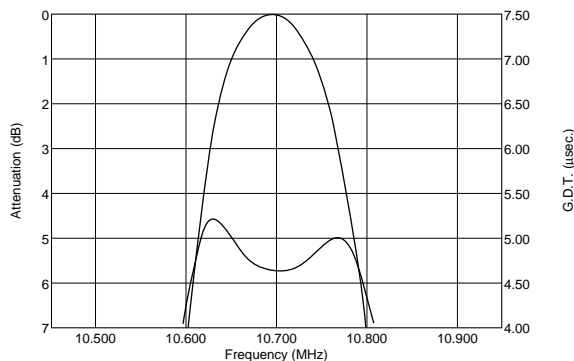

SFELB10M7HA00-B0

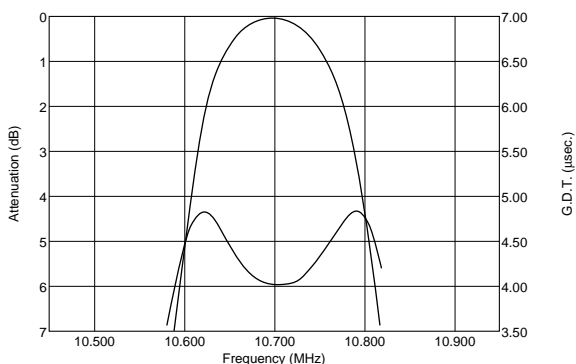

SFELB10M7GA00-B0

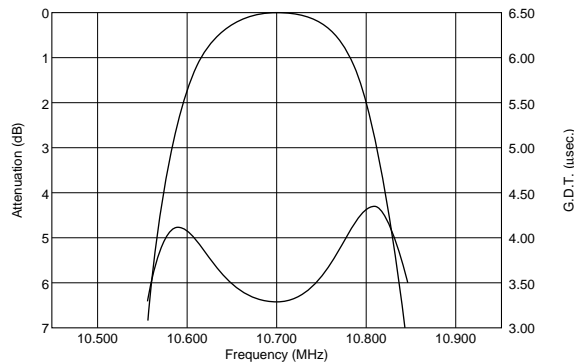

SFELB10M7FA00-B0

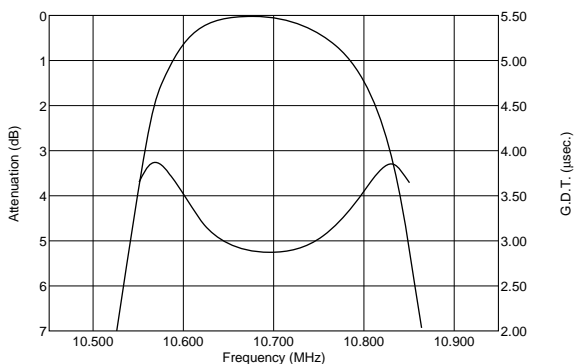

## ■ Frequency Characteristics (Spurious)

SFELB10M7KA00-B0

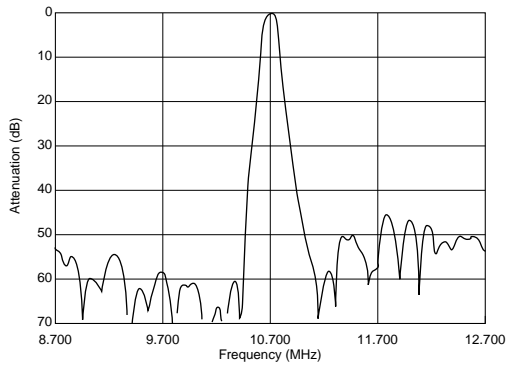

SFELB10M7JA00-B0

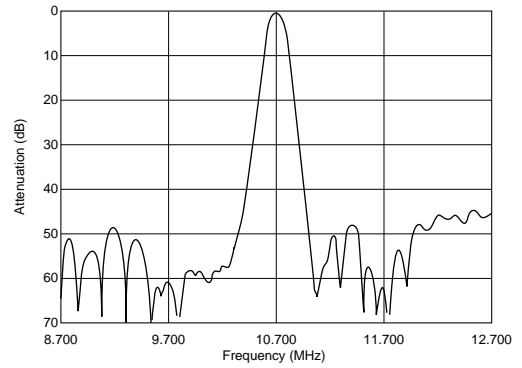

SFELB10M7HA00-B0

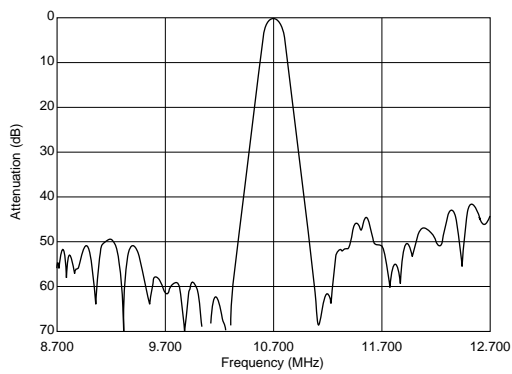

SFELB10M7GA00-B0

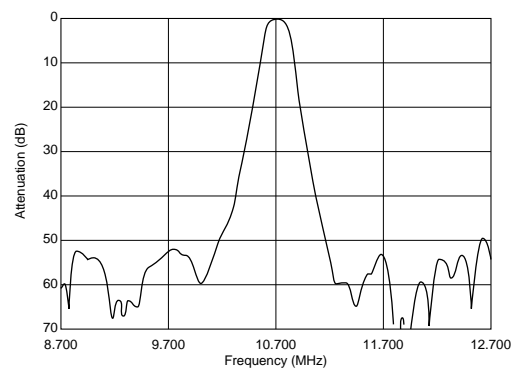

SFELB10M7FA00-B0

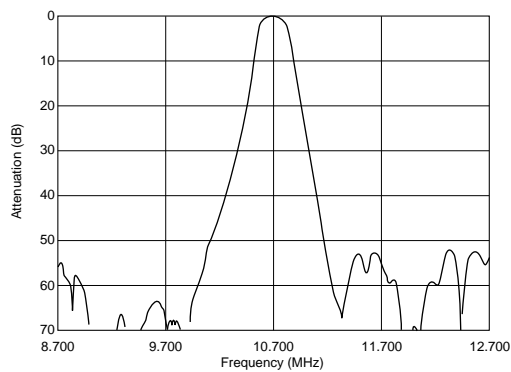

# Ceramic Filters (CERAFIL<sup>®</sup>) for FM Receivers



## CERAFIL<sup>®</sup> Lower Spurious Response Type

SFELA10M7 series for FM-receivers are monolithic type ceramic filters which use the energy trapped thickness vibration-mode of the piezoelectric ceramic.

**■ Features**

1. This type has lower spurious response compared to the standard filters.
2. This types are suitable for higher spurious suppression ratio.



SFELA10M7KAB0-B0

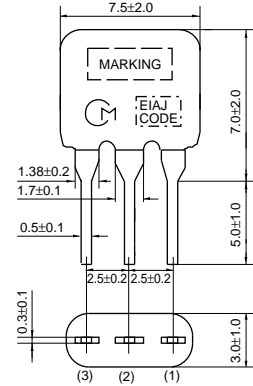

SFELA10M7JAB0-B0

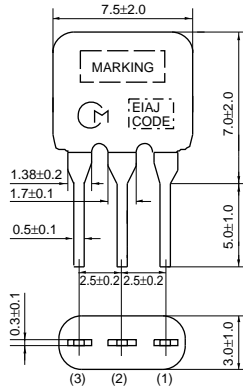

SFELA10M7HAB0-B0

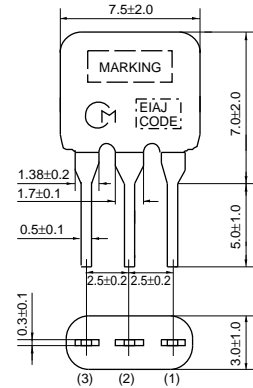

SFELA10M7GAB0-B0

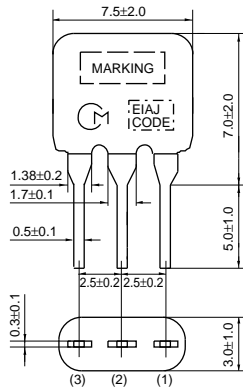

SFELA10M7FAB0-B0

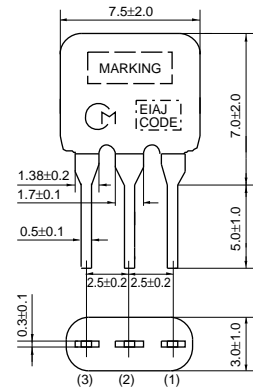

Part Number	Center Frequency (fo) (MHz)	3dB Bandwidth (kHz)	Attenuation (kHz)	Insertion Loss (dB)	Spurious Attenuation (dB)
SFELA10M7KAB0-B0	10.700 ±30kHz	within110 ±30kHz	350 max.	7.0 ±2.0dB	45 min.
SFELA10M7JAB0-B0	10.700 ±30kHz	within150 ±40kHz	380 max.	5.5 ±2.0dB	45 min.
SFELA10M7HAB0-B0	10.700 ±30kHz	within180 ±40kHz	520 max.	5.0 ±2.0dB	45 min.
SFELA10M7GAB0-B0	10.700 ±30kHz	within230 ±50kHz	570 max.	3.0 ±2.0dB	45 min.
SFELA10M7FAB0-B0	10.700 ±30kHz	within280 ±50kHz	650 max.	3.0 ±2.0dB	45 min.

Area of Attenuation : [within 20dB] Area of Spurious Attenuation : [within 9MHz to 12MHz]  
Center frequency(fo) defined by the center of 3dB bandwidth.

### Center Frequency Rank Code

CODE	30kHz Step	25kHz Step
D	10.64MHz±30kHz	10.650MHz±25kHz
B	10.67MHz±30kHz	10.675MHz±25kHz
A	10.70MHz±30kHz	10.700MHz±25kHz
C	10.73MHz±30kHz	10.725MHz±25kHz
E	10.76MHz±30kHz	10.750MHz±25kHz
Z	Combination A,B,C,D,E	
M	Combination A,B,C	

### Frequency Characteristics

SFELA10M7KAB0-B0

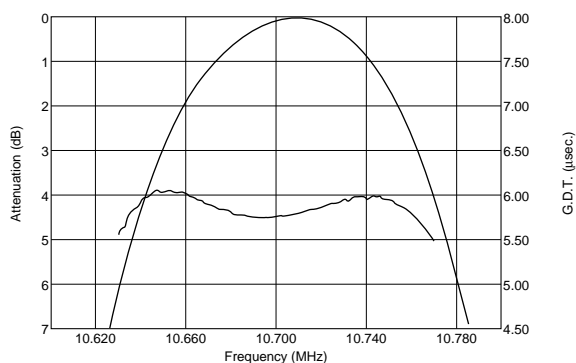

SFELA10M7JAB0-B0

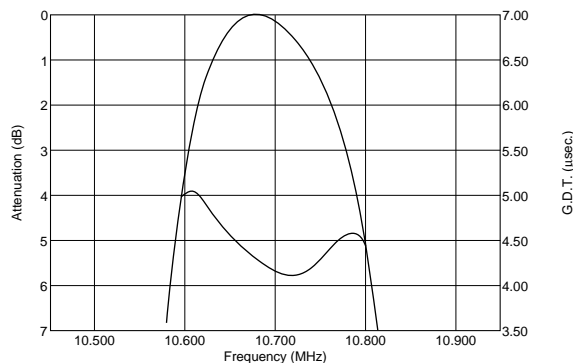

SFELA10M7HAB0-B0

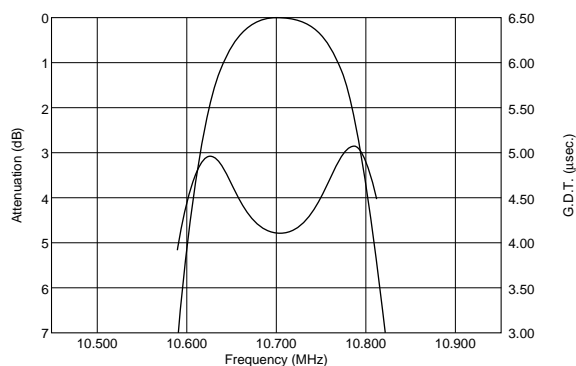

SFELA10M7GAB0-B0

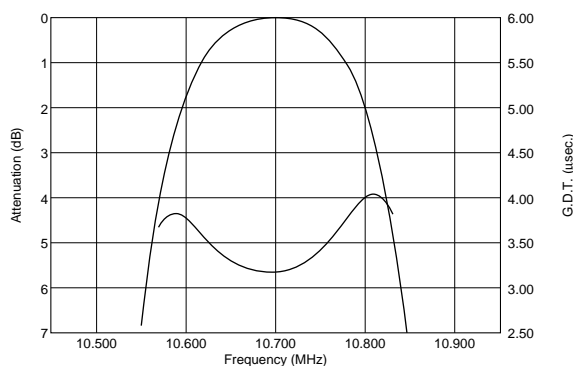

SFELA10M7FAB0-B0

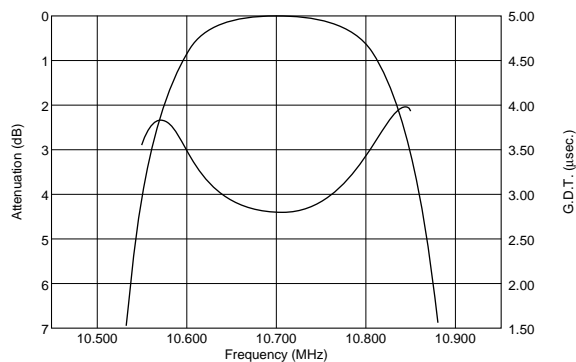

6

## Frequency Characteristics (Spurious)

SFELA10M7KAB0-B0

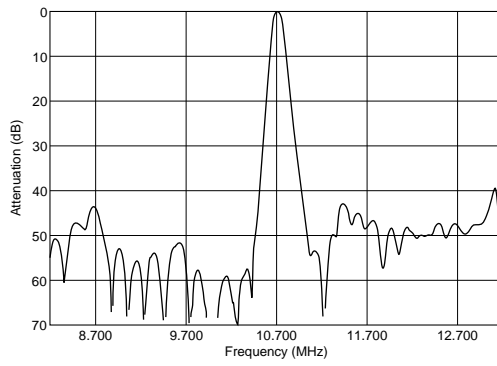

SFELA10M7JAB0-B0

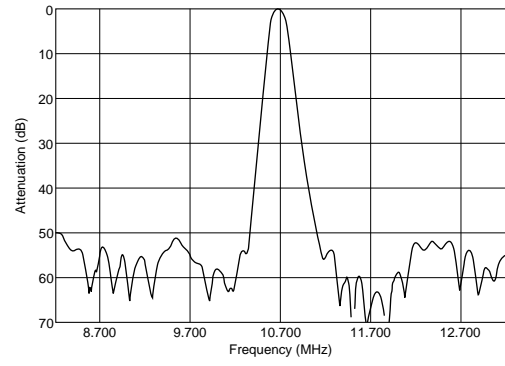

SFELA10M7HAB0-B0

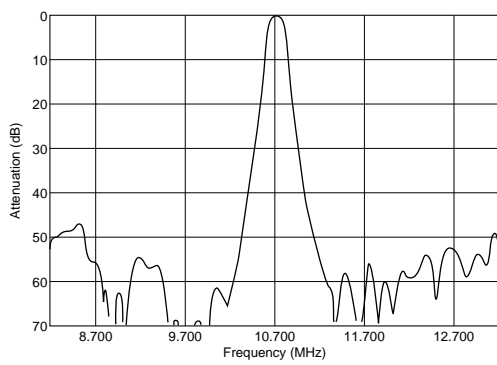

SFELA10M7GAB0-B0

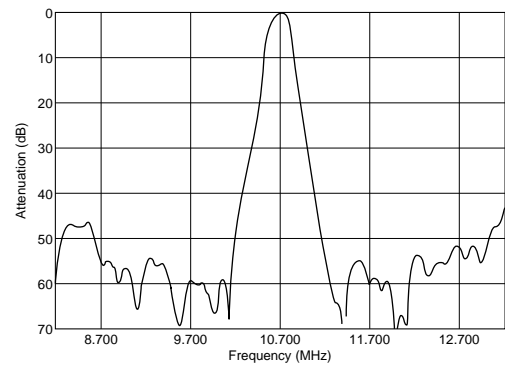

SFELA10M7FAB0-B0

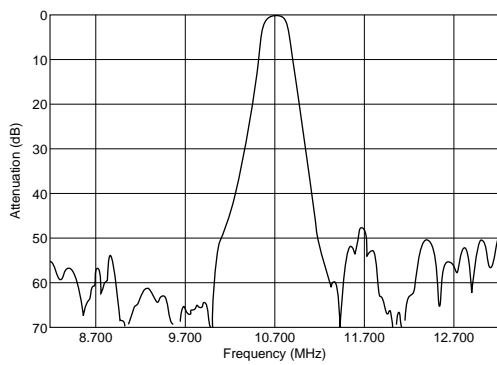

6

# Ceramic Filters (CERAFIL<sup>®</sup>) for FM Receivers



## CERAFIL<sup>®</sup> Wider Band-width Type

SFELA10M7 Series for FM-receivers are monolithic type ceramic filters which use the energy trapped thickness vibration-mode of the piezoelectric ceramic.

### ■ Features

1. Realizes wider or narrower band characteristics not obtained by conventional ceramic filters.
2. Temperature characteristics are the best available, the same as those of Murata's conventional ceramic filters. Thus, even in the case of narrow band filters, the center frequency is stable even if temperature changes.



SFELA10M7EA00-B0

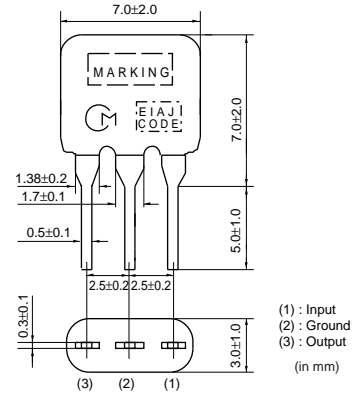

SFELA10M7DF00-B0

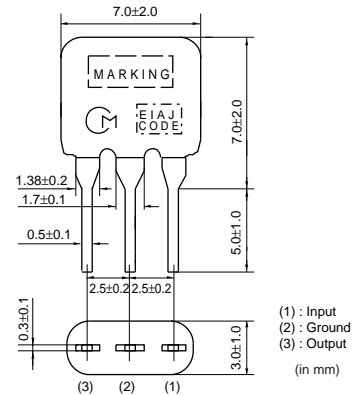

Part Number	Center Frequency (fo) (MHz)	Nominal Center Frequency(fn) (MHz)	3dB Bandwidth (kHz)	Attenuation (kHz)	Insertion Loss (dB)	Spurious Attenuation (dB)
SFELA10M7EA00-B0	10.700 ±30kHz	-	within330 ±50kHz	680 max.	within4.0 ±2.0dB	30 min.
SFELA10M7DF00-B0	-	10.700	fn±175 min.	950 max.	within3.0 ±2.0dB	20 min.

Area of Attenuation : [within 20dB] Area of Spurious Attenuation : [within 9MHz to 12MHz]  
 Center frequency(fo) defined by the center of 3dB bandwidth.  
 (fn) means nominal center frequency.

### ■ Center Frequency Rank Code

CODE	30kHz Step	25kHz Step
D	10.64MHz±30kHz	10.650MHz±25kHz
B	10.67MHz±30kHz	10.675MHz±25kHz
A	10.70MHz±30kHz	10.700MHz±25kHz
C	10.73MHz±30kHz	10.725MHz±25kHz
E	10.76MHz±30kHz	10.750MHz±25kHz
Z	Combination A,B,C,D,E	
M	Combination A,B,C	



## Frequency Characteristics

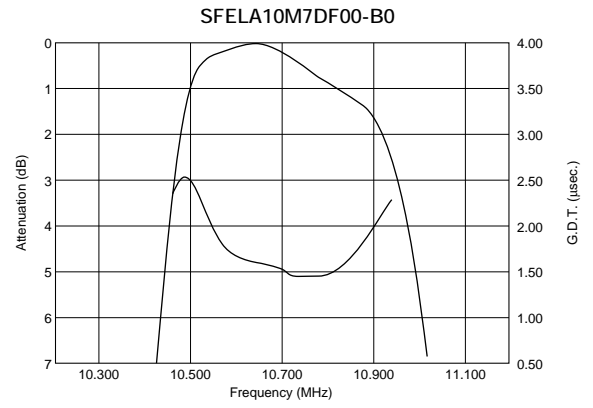
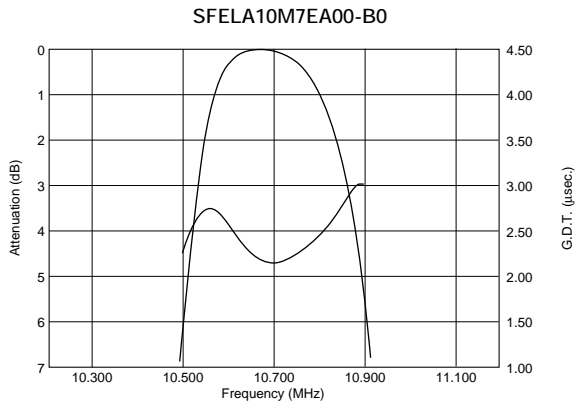

## Frequency Characteristics (Spurious)

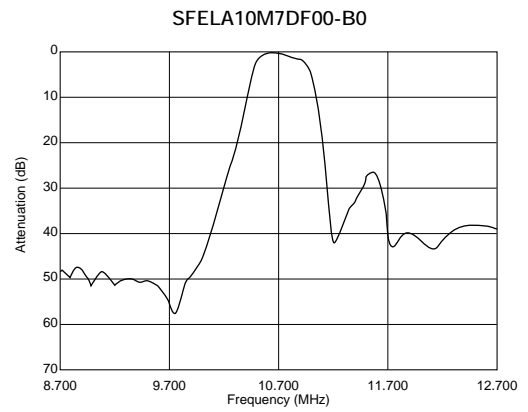
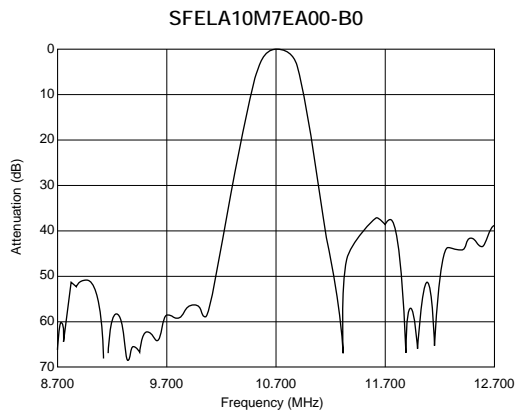

# Ceramic Filters (CERAFIL<sup>®</sup>) for FM Receivers



## CERAFIL<sup>®</sup> Narrow Band Type

SFELA10M7LFTA/KAH0, SFVLA/SFKLA series realizes narrower band characteristics not obtained by conventional ceramic filters. Besides, low spurious and temperature characteristics is stable. This series suits for European car-audio or AM up conversion use that needs narrow band characteristics.



SFKLA10M7NF00-B0

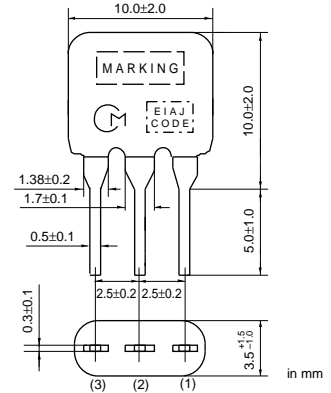

SFVLA10M7MF00-B0

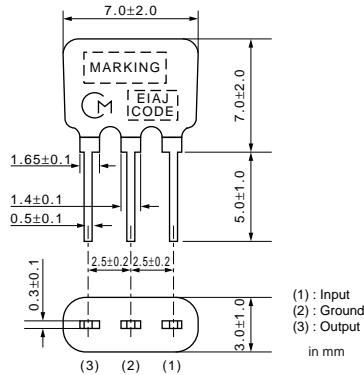

SFVLA10M7LF00-B0

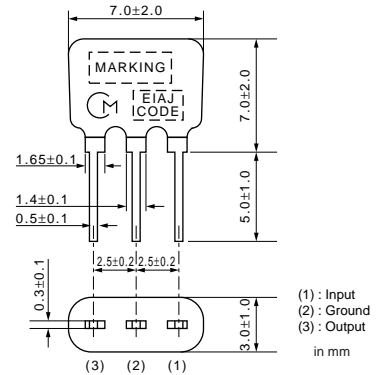

SFELA10M7LFTA01-B0

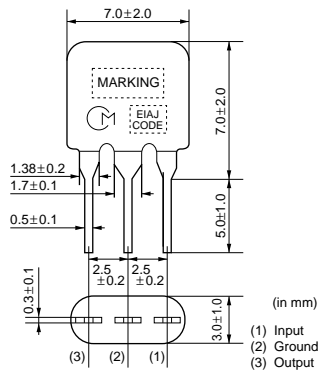

SFELA10M7KAH0-B0

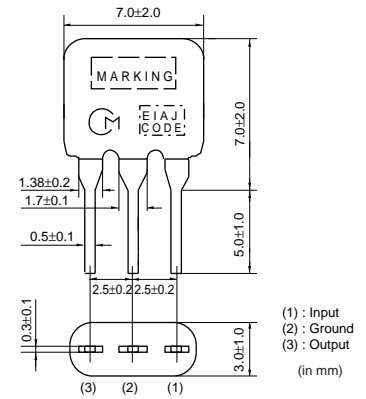

Part Number	Center Frequency (fo) (MHz)	Nominal Center Frequency(fn) (MHz)	3dB Bandwidth (kHz)	Attenuation (kHz)	Insertion Loss (dB)	Spurious Attenuation (dB)
SFKLA10M7NF00-B0	10.700 ±15kHz	-	20 min.	95 max.	6.0 max.	24 min.
SFVLA10M7MF00-B0	-	10.700	f±13 min.	135 max.	within 5.5 ±2.5dB	30 min.
SFVLA10M7LF00-B0	-	10.700	f±25 min.	200 max.	within 5.5 ±2.5dB	30 min.
SFELA10M7LFTA-B0	-	10.700	f±25 min.	280 max.	within 7.0 ±2.0dB	30 min.
SFELA10M7KAH0-B0	10.700 ±30kHz	-	within 110 ±30kHz	350 max.	within 7.0 ±2.0dB	30 min.

Area of Attenuation : [within 20dB] Area of Spurious Attenuation : [within 9MHz to 12MHz]

### Center Frequency Rank Code

CODE	30kHz Step	25kHz Step
<b>D</b>	10.64MHz±30kHz	10.650MHz±25kHz
<b>B</b>	10.67MHz±30kHz	10.675MHz±25kHz
<b>A</b>	10.70MHz±30kHz	10.700MHz±25kHz
<b>C</b>	10.73MHz±30kHz	10.725MHz±25kHz
<b>E</b>	10.76MHz±30kHz	10.750MHz±25kHz
<b>Z</b>	Combination A,B,C,D,E	
<b>M</b>	Combination A,B,C	

### Frequency Characteristics

SFKLA10M7NF00-B0

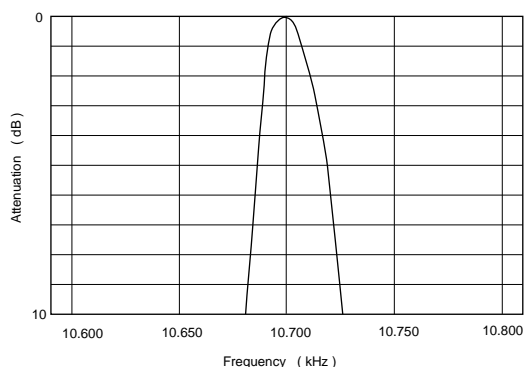

SFVLA10M7MF00-B0

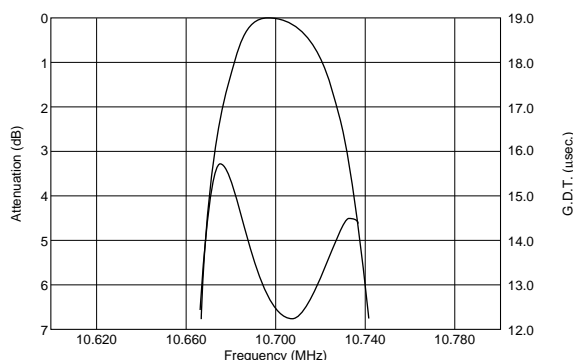

SFVLA10M7LF00-B0

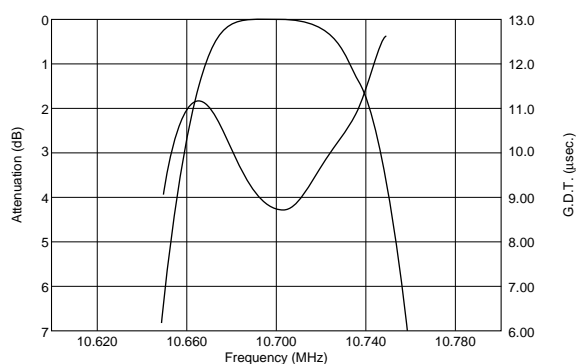

SFELA10M7LFTA01-B0

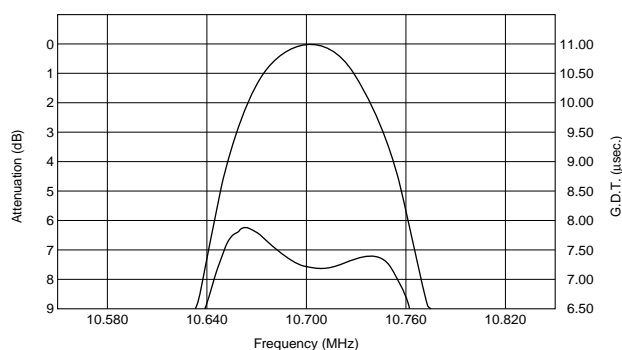

SFELA10M7KAH0-B0

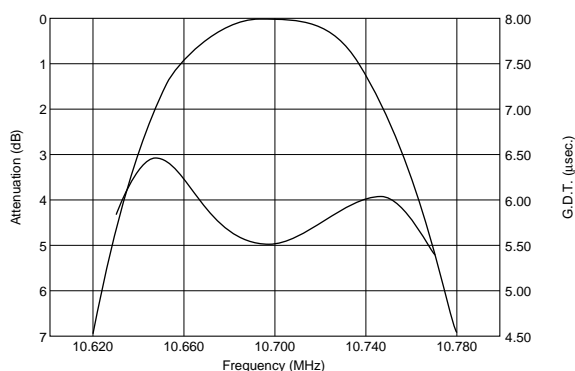

## ■ Frequency Characteristics (Spurious)

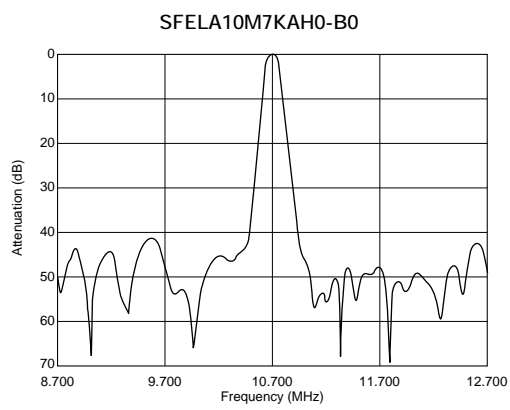
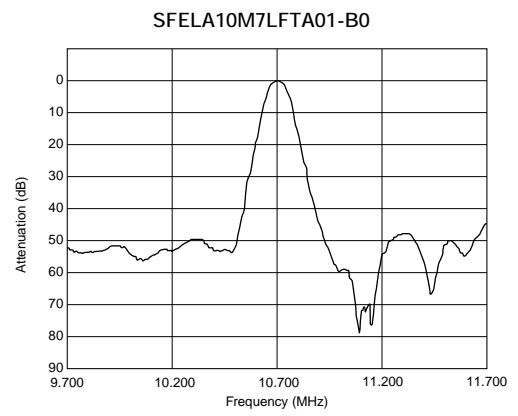
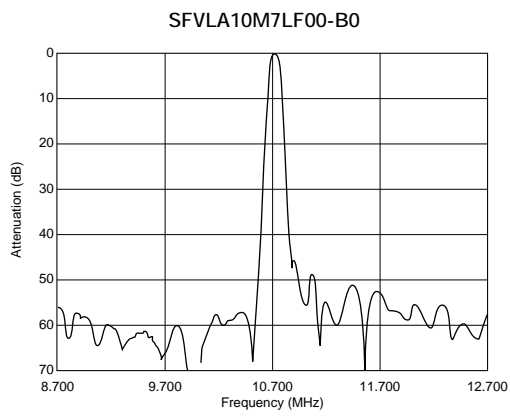
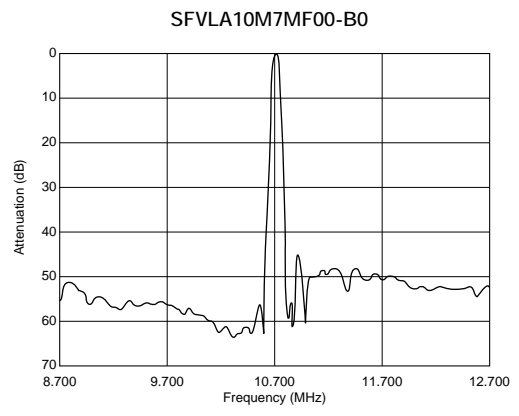
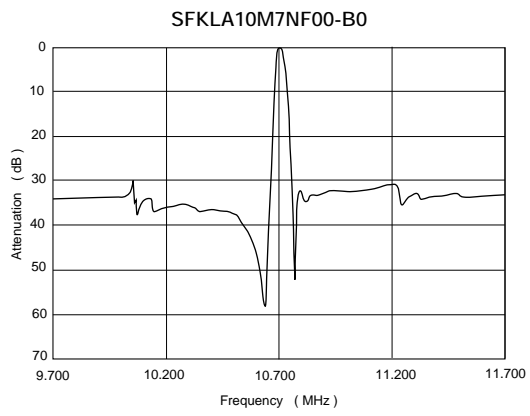

# Ceramic Filters (CERAFIL<sup>®</sup>) for FM Receivers



## CERAFIL<sup>®</sup> For FM -IF Tuners

SFELA10M7 series for FM-receivers are monolithic type ceramic filters which use the energy trapped thickness vibration-mode of the piezoelectric ceramic.

### ■ Features

1. Little dispersion of amplitude characteristics and phase characteristics (G. D. T. characteristics).
2. The SFELA10M7G\_X series has G. D. T characteristics and is useful for obtaining low distortion. SFELA10M7F\_L series, in these ceramic filters, being in harmony with flatness of G. D. T. , roundness of the amplitude and selectivity characteristics, therefore, these ceramic filters are suitable to high-grade stereo tuners. Even if mismatching condition, they can keep little distortion because of low Qm of ceramic material. The SFELA10M7FA0G series is based on SFELA10M7FA00/GA00/HA00, and it obtains high selectivity with low loss. There is little dispersion of amplitude and G. D. T. characteristics, and low distortion rate can be obtained.
3. All products are inspected for symmetry and roundness of amplitude characteristics, and the flatness of G. D. T. characteristics.



SFELA10M7JAXE-B0

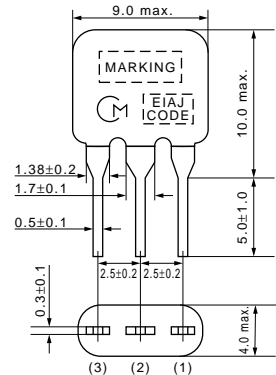

SFELA10M7HA0G-B0

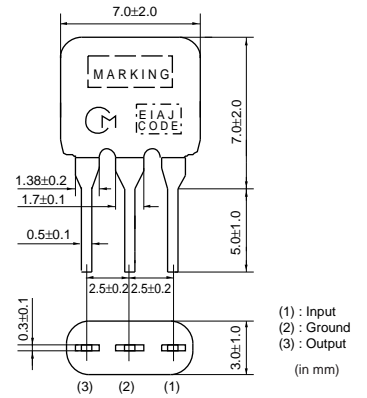

SFELA10M7HAXD-B0

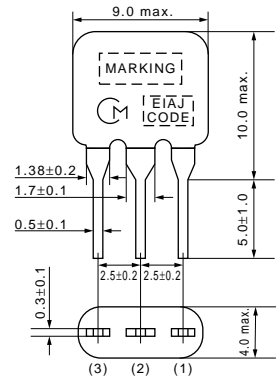

SFELA10M7GA0G-B0

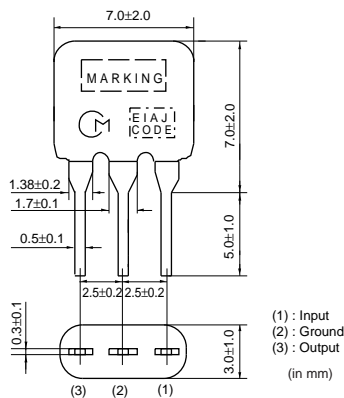

SFELA10M7GALM-B0

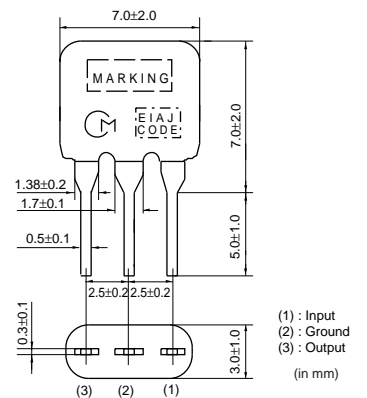

Continued on the following page. ↗

Continued from the preceding page.

SFELA10M7GAXA-B0

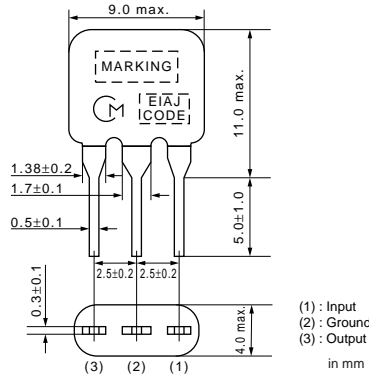

SFELA10M7FA0G-B0

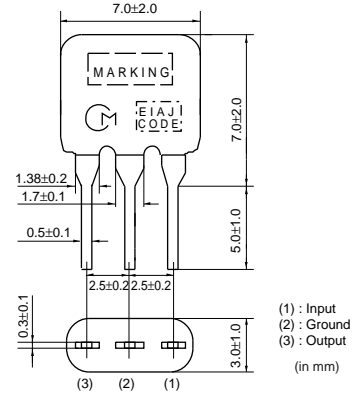

SFELA10M7GALP03-B0

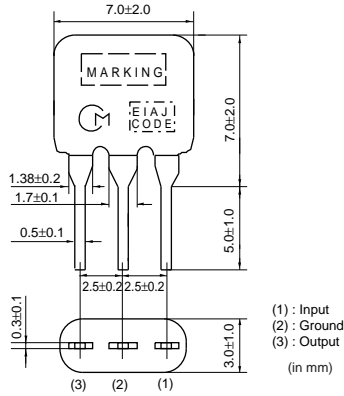

SFELA10M7GAXX-B0

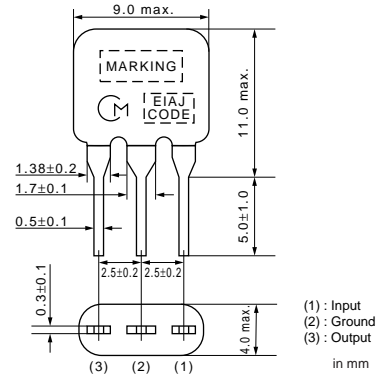

SFELA10M7FALL-B0

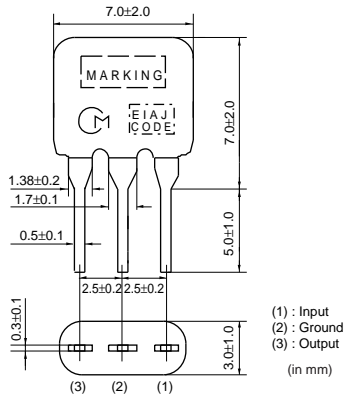

Part Number	Center Frequency (fo) (MHz)	3dB Bandwidth (kHz)	Attenuation (kHz)	Insertion Loss (dB)	Spurious Attenuation (dB)	GDT Bandwidth (kHz)
SFELA10M7JAXE-B0	10.700 ±30kHz	within150 ±30kHz	500 max.	14.0 max.	35 min.	fo±50 min.[within 0.15µsec.]
SFELA10M7HA0G-B0	10.700 ±30kHz	within180 ±40kHz	520 max.	7.0 max.	40 min.	fo±45 min.[within 0.5µsec.]
SFELA10M7HAXD-B0	10.700 ±30kHz	within180 ±30kHz	530 max.	14.0 max.	33 min.	fo±60 min.[within 0.15µsec.]
SFELA10M7GA0G-B0	10.700 ±30kHz	within230 ±50kHz	600 max.	7.0 max.	40 min.	fo±60 min.[within 0.5µsec.]
SFELA10M7GALM-B0	10.700 ±30kHz	within230 ±50kHz	600 max.	within9.0 ±2.0dB	30 min.	fo±60 min.[within 0.25µsec.]
SFELA10M7GAXA-B0	10.700 ±30kHz	within220 ±40kHz	610 max.	12.5 max.	30 min.	fo±80 min.[within 0.15µsec.]
SFELA10M7FA0G-B0	10.700 ±30kHz	within280 ±50kHz	650 max.	within4.0 ±2.0dB	30 min.	fo±85 min.[within 0.5µsec.]
SFELA10M7GALP03-B0	10.700 ±30kHz	within250 ±50kHz	650 max.	10.0 max.	30 min.	fo±65 min.[within 0.25µsec.]
SFELA10M7GAXX-B0	10.700 ±30kHz	within250 ±40kHz	670 max.	12.0 max.	25 min.	fo±110 min.[within 0.2µsec.]
SFELA10M7FALL-B0	10.700 ±30kHz	within280 ±50kHz	700 max.	within7.0 ±2.0dB	25 min.	fo±70 min.[within 0.25µsec.]

Area of Attenuation : [within 20dB] Area of Spurious Attenuation : [within 9MHz to 12MHz]  
Center frequency(fo) defined by the center of 3dB bandwidth.

### Center Frequency Rank Code

CODE	30kHz Step	25kHz Step
D	10.64MHz±30kHz	10.650MHz±25kHz
B	10.67MHz±30kHz	10.675MHz±25kHz
A	10.70MHz±30kHz	10.700MHz±25kHz
C	10.73MHz±30kHz	10.725MHz±25kHz
E	10.76MHz±30kHz	10.750MHz±25kHz
Z	Combination A,B,C,D,E	
M	Combination A,B,C	

### Freq. Characteristics

SFELA10M7JAXE-B0

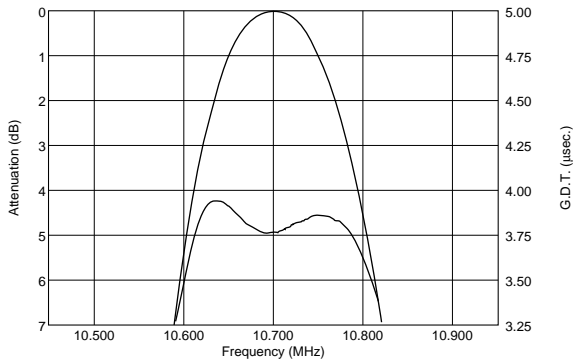

SFELA10M7HA0G-B0

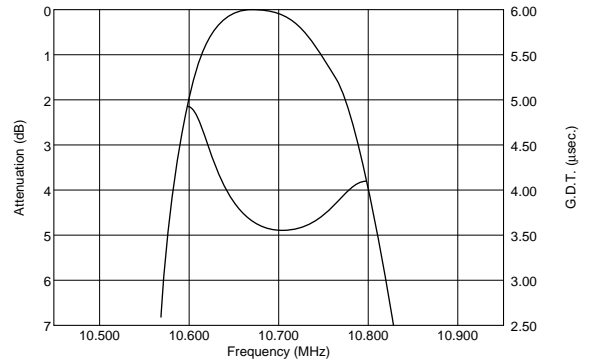

SFELA10M7HAXD-B0

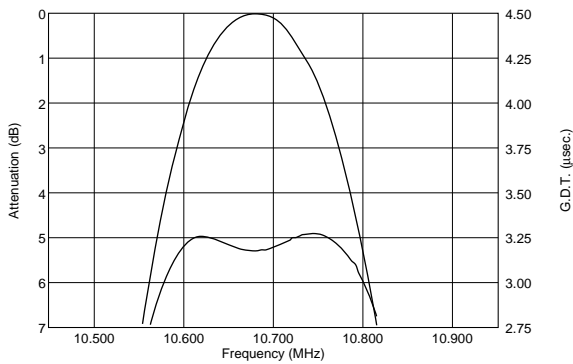

SFELA10M7GA0G-B0

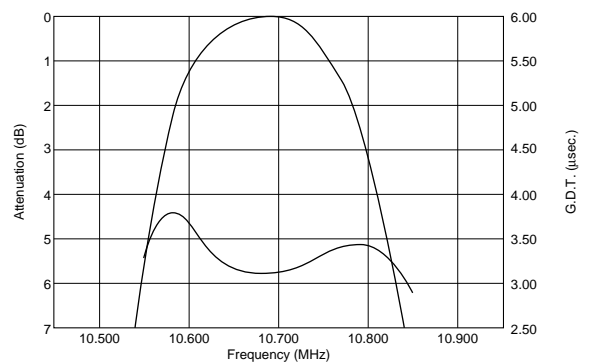

SFELA10M7GALM-B0

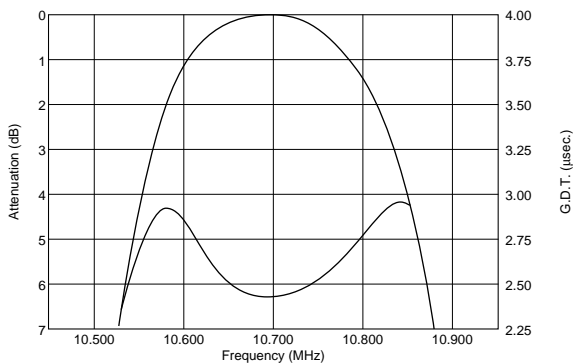

SFELA10M7GAXA-B0

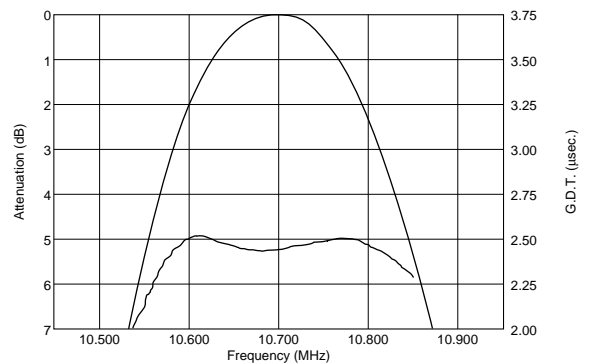

Continued on the following page. ↗

9

 Continued from the preceding page.

**■ Freq. Characteristics**

SFELA10M7FA0G-B0

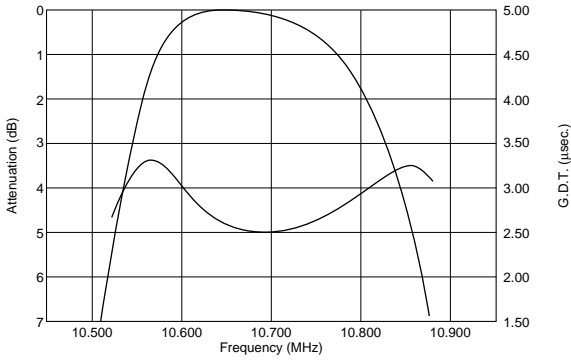

SFELA10M7GALP03-B0

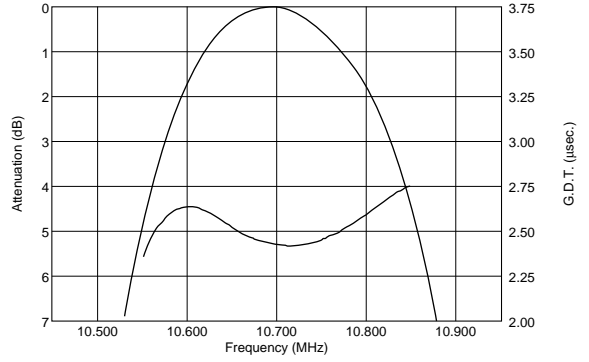

SFELA10M7GAXX-B0

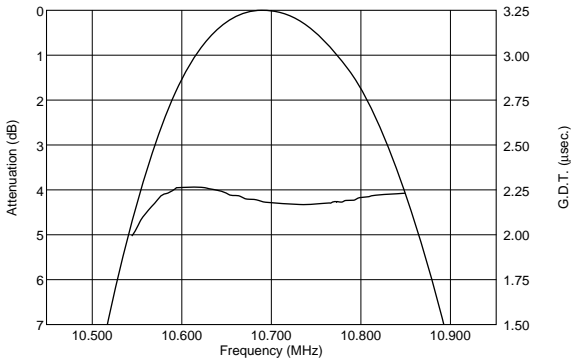

SFELA10M7FALL-B0

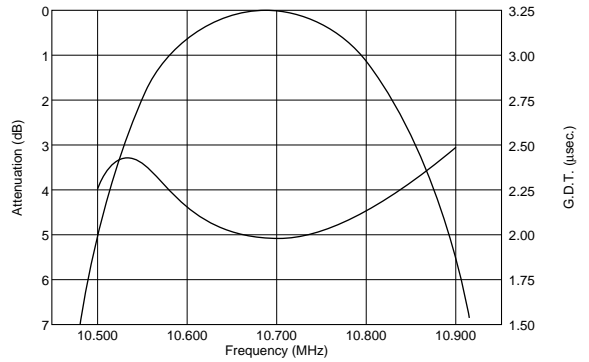

**■ Spurious Frequency**

SFELA10M7JAXE-B0

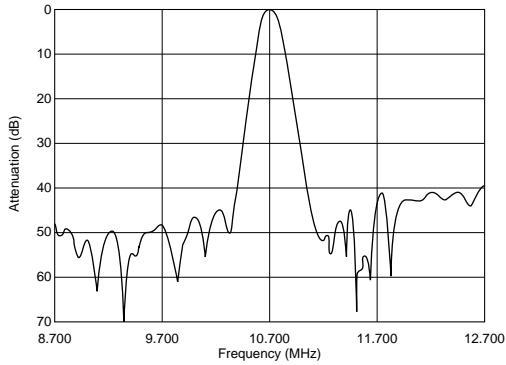

SFELA10M7HA0G-B0

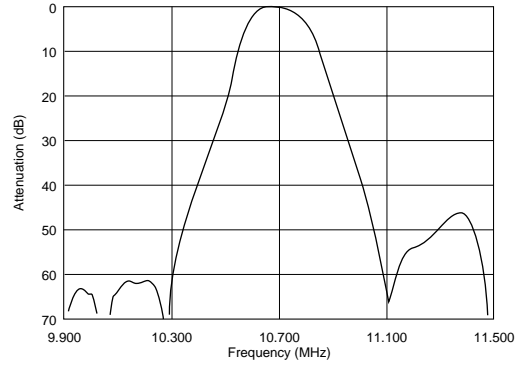

SFELA10M7HAXD-B0

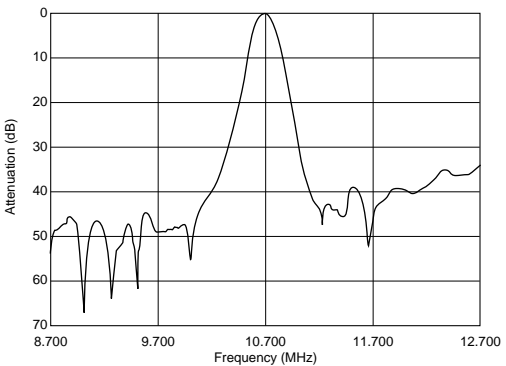

SFELA10M7GA0G-B0

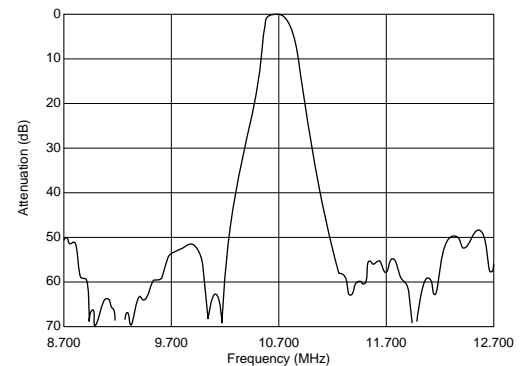

Continued on the following page. 



Continued from the preceding page.

### Spurious Frequency

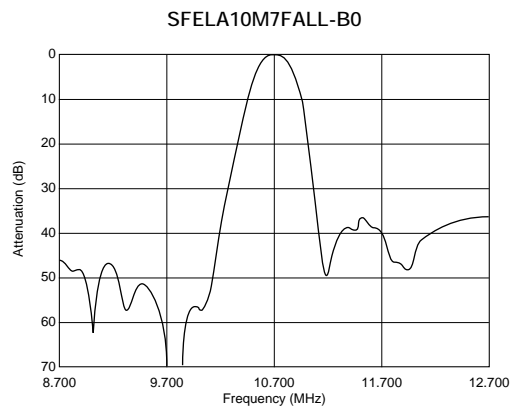
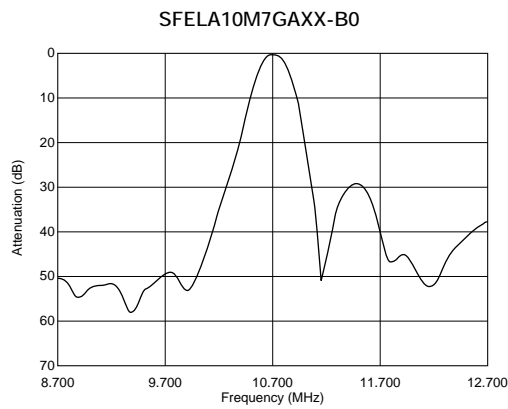
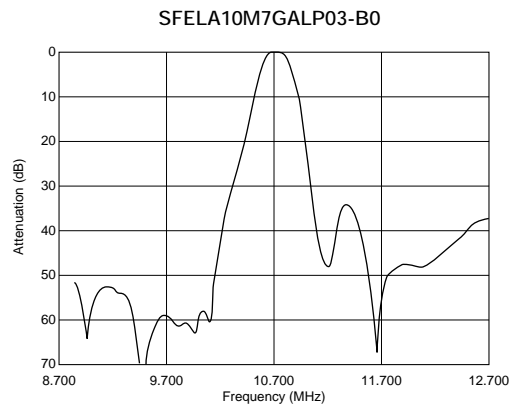
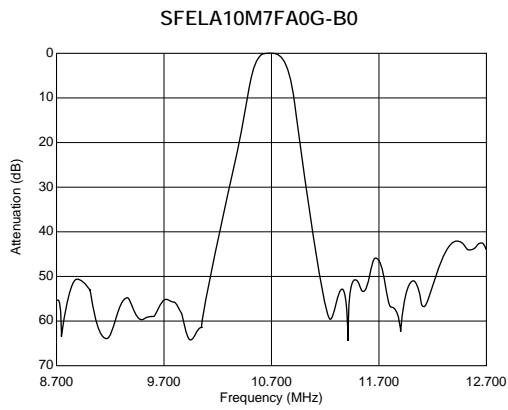
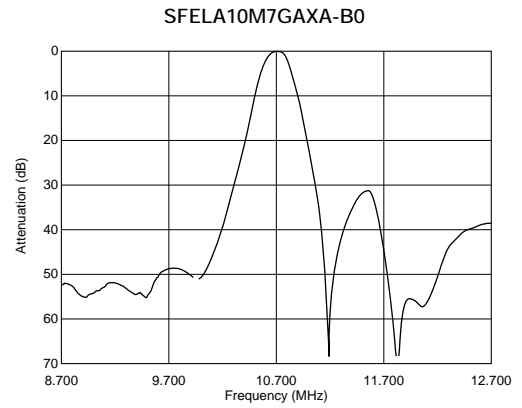
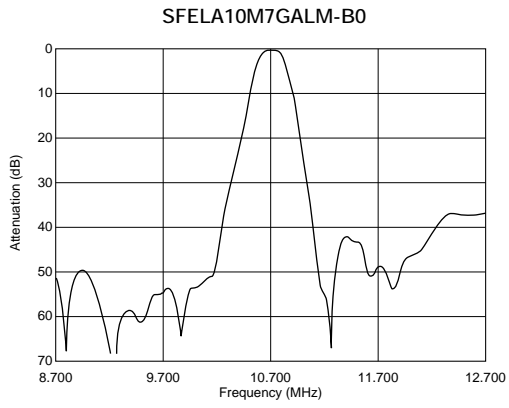

# Ceramic Filters (CERAFIL<sup>®</sup>) for FM Receivers



## CERAFIL<sup>®</sup> Three-Elements Type SFTLA Series

SFTLA10M7 series for FM-receivers are monolithic type ceramic filters which use the energy trapped thickness vibration-mode of the piezoelectric ceramic.

### ■ Features

1. It has an excellent shape factor, and it is possible to obtain 1.5 times more excellent selectivity than SFELA10M7 series (by detuning  $\pm 300$  or  $400\text{kHz}$ ).
2. Good performance of spurious suppression.
3. Having the same terminal pitch as the SFELA10M7 series, it easily replaces that series.
4. By replacing two SFELA10M7 series filters with one SFTLA10M7 filter, more compact sets can be made.
5. Well-suited for 1-chip ICs.



SFTLA10M7HA00-B0

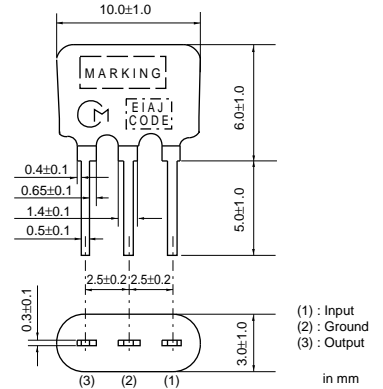

SFTLA10M7GA00-B0

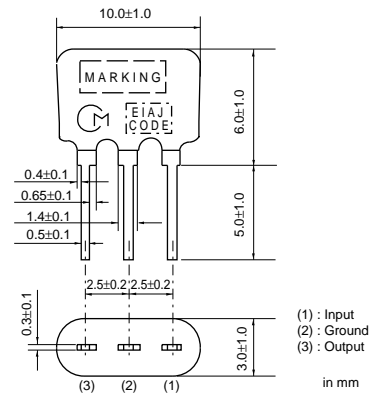

SFTLA10M7FA00-B0

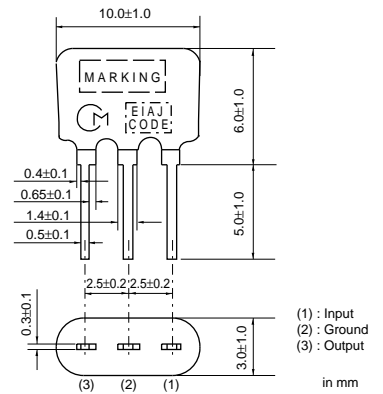

10

Part Number	Center Frequency (fo) (MHz)	3dB Bandwidth (kHz)	Attenuation (kHz)	Insertion Loss (dB)	Spurious Attenuation (dB)
SFTLA10M7HA00-B0	10.700 ±30kHz	within 180 ±40kHz	550 max.	within 5.5 ±2.5dB	50 min.
SFTLA10M7GA00-B0	10.700 ±30kHz	within 230 ±40kHz	650 max.	within 6.0 ±2.0dB	50 min.
SFTLA10M7FA00-B0	10.700 ±30kHz	within 280 ±50kHz	700 max.	within 6.0 ±2.0dB	50 min.

Area of Attenuation : [within 40dB] Area of Spurious Attenuation : [within 9MHz to 12MHz]  
Center frequency(fo) defined by the center of 3dB bandwidth.

### Center Frequency Rank Code

CODE	30kHz Step	25kHz Step
D	10.64MHz±30kHz	10.650MHz±25kHz
B	10.67MHz±30kHz	10.675MHz±25kHz
A	10.70MHz±30kHz	10.700MHz±25kHz
C	10.73MHz±30kHz	10.725MHz±25kHz
E	10.76MHz±30kHz	10.750MHz±25kHz
Z	Combination A,B,C,D,E	
M	Combination A,B,C	

### Frequency Characteristics

SFTLA10M7HA00-B0

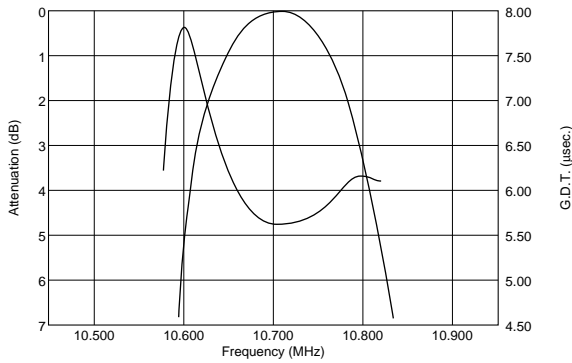

SFTLA10M7GA00-B0

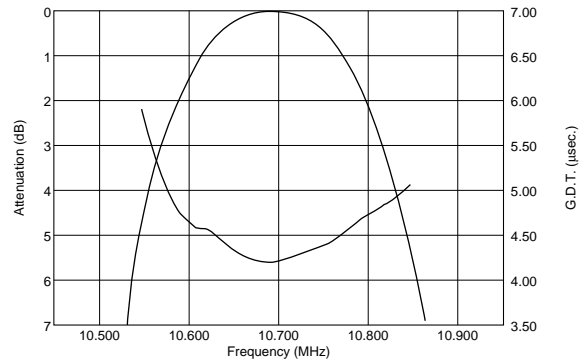

SFTLA10M7FA00-B0

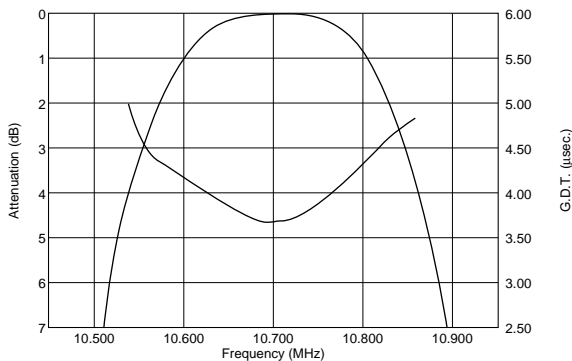

### Frequency Characteristics (Spurious)

SFTLA10M7HA00-B0

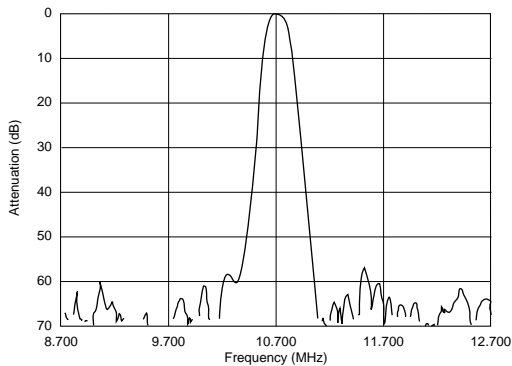

SFTLA10M7GA00-B0

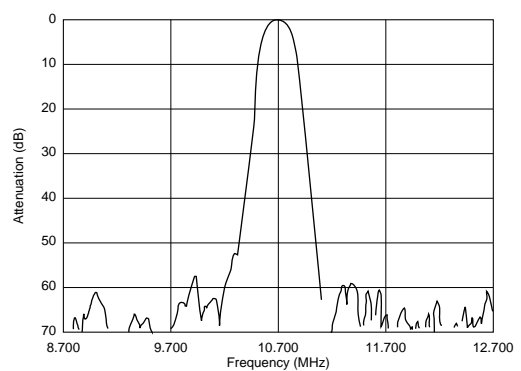

Continued on the following page.

Continued from the preceding page.

### Frequency Characteristics (Spurious)

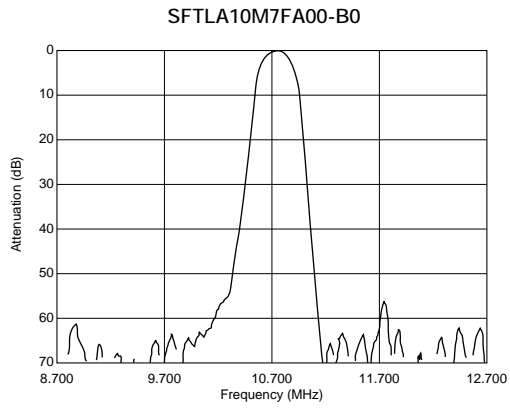

# Lead Type CERAFIL<sup>®</sup> Test Circuit and Characteristics Data

## ■ Test Circuit

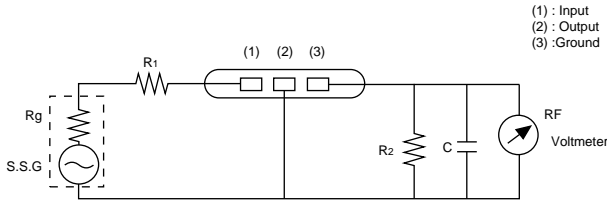

$R_g + R_1 = R_2 = 330\Omega$   
 $C = 10\text{pF}$  (Including stray capacitance and input capacitance of RF voltmeter.)

## ■ Temperature Characteristics

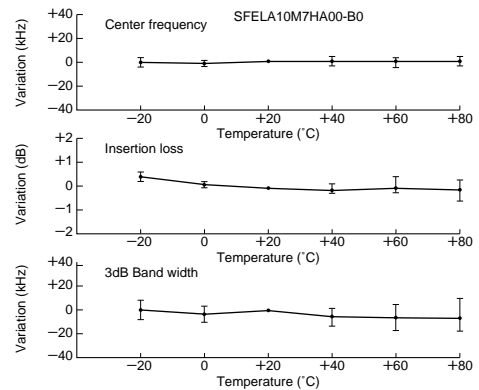
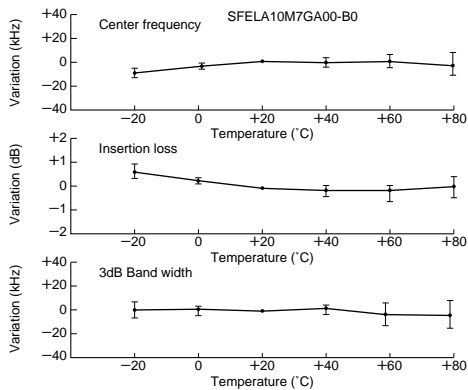

## ■ Matching Conditions

- When using ceramic filters, it is most important to match the input/output load to impedance 330 ohm (only SFELA10M7DF00-B0 is 470 ohm matching). Waveform symmetry is damaged when reactance is added to the input/output load.
- Two ceramic filters directly connected can be used for high selectivity. For reducing waveform variation, it is recommended to input a buffer AMP between ceramic filters.

- The SFELA10M7 and SFTLA10M7 series are of input/output symmetric structure so that in theory there is no input/output directionality. Actual circuits may use different input/output loading conditions (for example, mismatched impedance) or capacitance load. In such cases, the waveform will be a little changed by the direction of the input/output of the ceramic filters.

## Lead Type CERAFIL<sup>®</sup> Characteristics Data and Notice

### ■ Loaded Resistance and Waveform ( $R_g+R_1=330\text{ohm}$ )

SFELA10M7GA00-B0

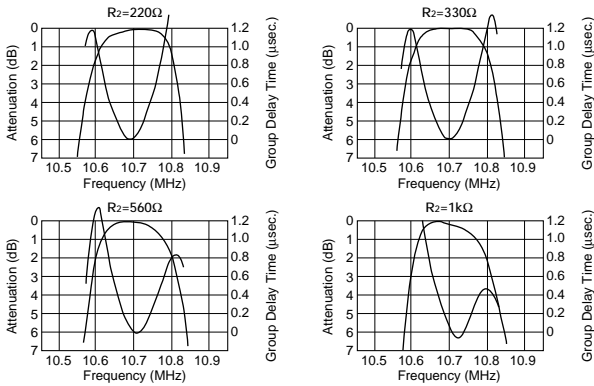

### ■ Loaded Capacitance and Waveform ( $R_g+R_1=R_2=330\text{ohm}$ )

SFELA10M7GA00-B0

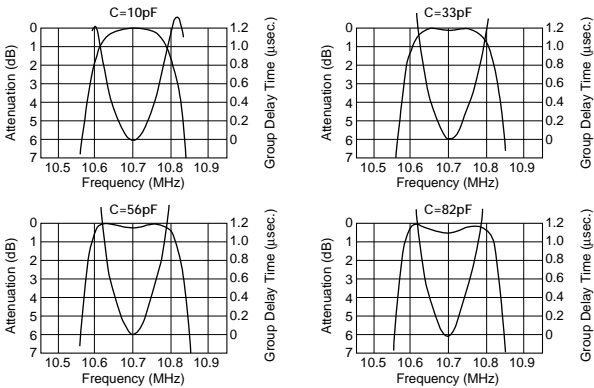

### ■ Notice (Soldering and Mounting)

The component cannot be withstand washing.

### ■ Notice (Handling)

1. Do not use this product with bend. The component may be damaged if excess mechanical stress is applied to it mounted on the printed circuit board.
2. The component may be damaged when an excess stress will be applied.
3. All kinds of re-flow soldering must not be applied on the component.
4. Do not clean or wash the component as it is not hermetically sealed.
5. Do not use strong acidity flux, more than 0.2wt% chlorine content, in flow soldering.
6. In case of covering discriminator with over coat, conditions such as material of resin, cure temperature, and so on should be evaluated well.
7. Accurate test circuit values are required to measure electrical characteristics. It may be a cause of mis-correlation if there is any deviation, especially stray capacitance, from the test circuit in the specification.

# Ceramic Filters (CERAFIL<sup>®</sup>) for FM Receivers



## Discriminators Chip Type CDACV Series

CDACV10M7 series forms a resonator on a piezoelectric ceramic substrate. In combination with ICs, this type obtains stable demodulation characteristics in wide bandwidths.

### ■ Features

1. Compact and excellent mechanical strength.
2. Can be combined with various ICs. The IC is determined by the last number in the part number.
3. Stable demodulation characteristics can be obtained without adjustment.
4. The MG type for wide bandwidths and the MC type for narrow bandwidths are available.
5. Stable temperature characteristics.
6. We recommend kits : ceramic discriminator CDACV10M7 series and "CERAFIL" SFECV10M7 of the same frequency rank.

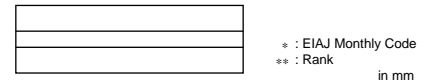
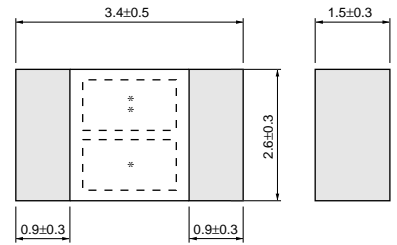

Part Number	Center Frequency (fo) (MHz)	Recovered Audio 3dB BW (kHz)	Recovered Audio Output (mV)	Distortion (%)	IC	Detection Method
CDACV10M7GA001-R0	10.700 ±30kHz	fo±150 min.	55 min.	1.0 max.	CX20029	Quadrature
CDACV10M7GA016-R0	10.700 ±30kHz	300 min.	within 60 to 90mV	0.9 max.	TA8122F	Quadrature
CDACV10M7GA046-R0	10.700 ±30kHz	330 min.	280 min.	1.5 max.	LA1832	Quadrature
CDACV10M7GA069-R0	10.700 ±30kHz	330 min.	80 min.	1.0 max.	CXA1538N	Quadrature
CDACV10M7CA001-R0	10.700 ±30kHz	fo±150 min.	55 min.	1.0 max.	CX20091	Quadrature

### ■ Center Frequency Rank Code

CODE	30kHz Step	25kHz Step
D	10.64MHz±30kHz	10.650MHz±25kHz
B	10.67MHz±30kHz	10.675MHz±25kHz
A	10.70MHz±30kHz	10.700MHz±25kHz
C	10.73MHz±30kHz	10.725MHz±25kHz
E	10.76MHz±30kHz	10.750MHz±25kHz
Z	Combination A,B,C,D,E	
M	Combination A,B,C	

### ■ Standard Land Pattern Dimensions

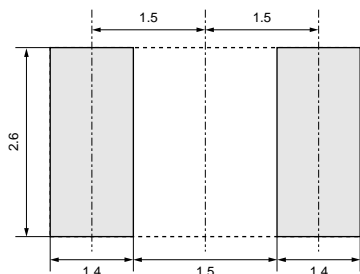

11

■ CDACV10M7GA001-R0

Test Circuit

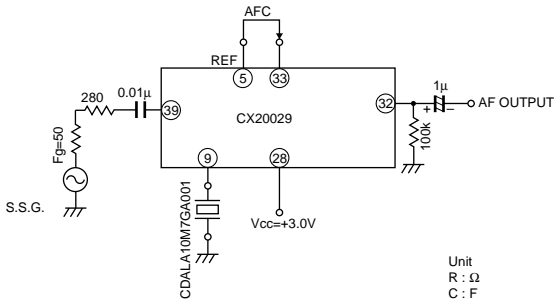

Unit  
R : Ω  
C : F

Frequency Characteristics

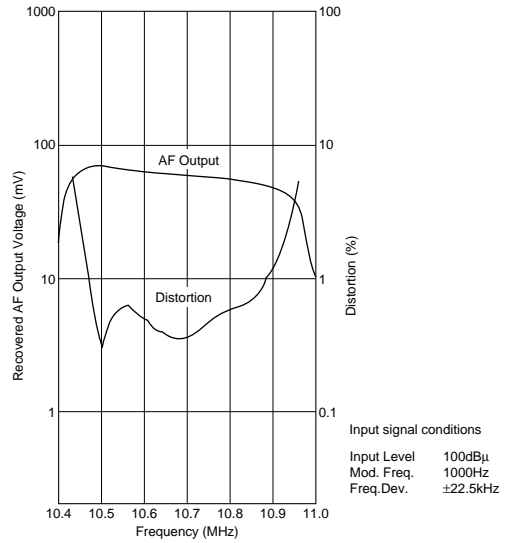

■ CDACV10M7GA016-R0

Test Circuit

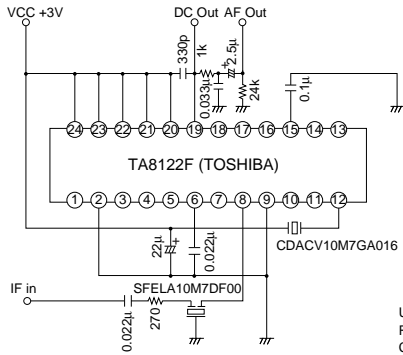

Unit  
R : Ω  
C : F

Frequency Characteristics

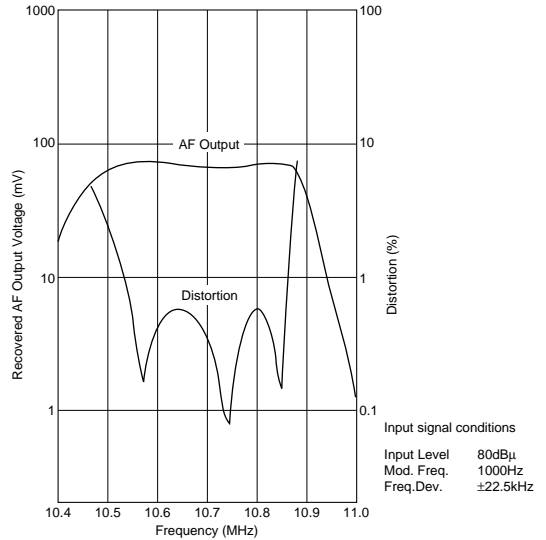

■ CDACV10M7GA046-R0

Test Circuit

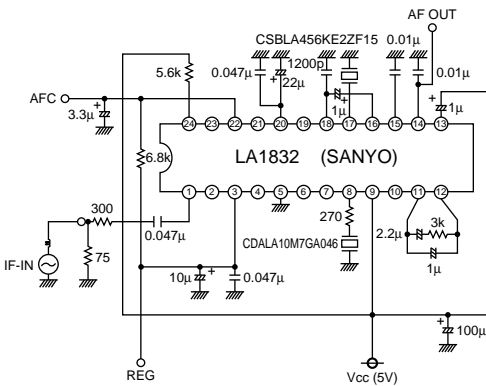

Unit  
R : Ω  
C : F

Frequency Characteristics

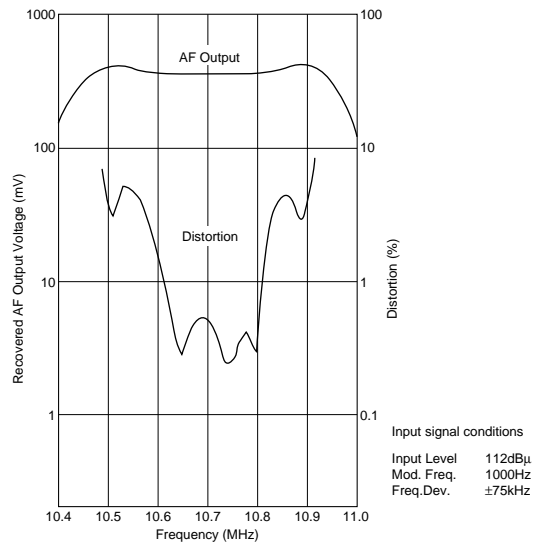



Continued from the preceding page.

■ CDACV10M7GA069-R0

Test Circuit

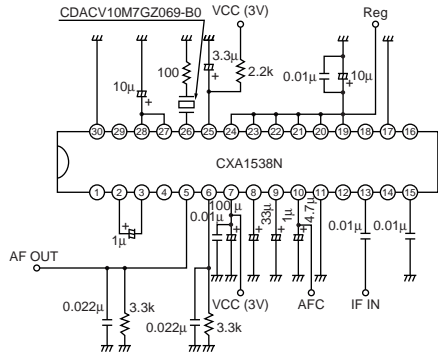

Unit  
R : Ω  
C : F

Frequency Characteristics

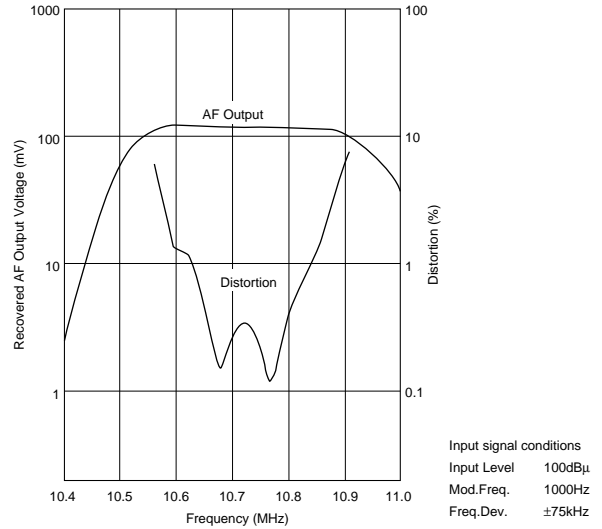

■ CDACV10M7CA001-R0

Test Circuit

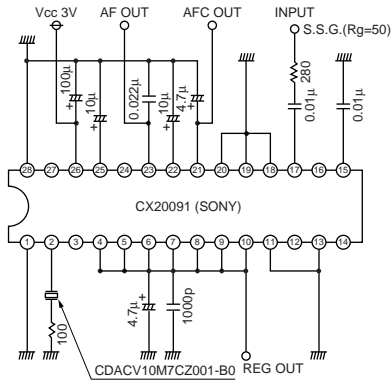

Unit  
R : Ω  
C : F

Frequency Characteristics

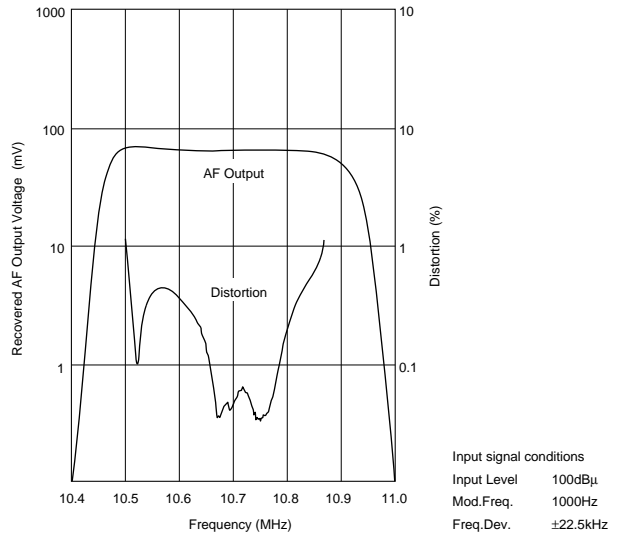

## Chip Type Discriminators CDACV Series Notice

### ■ Notice (soldering and mounting)

#### 1. Standard Reflow Soldering Condition

##### (1) Reflow

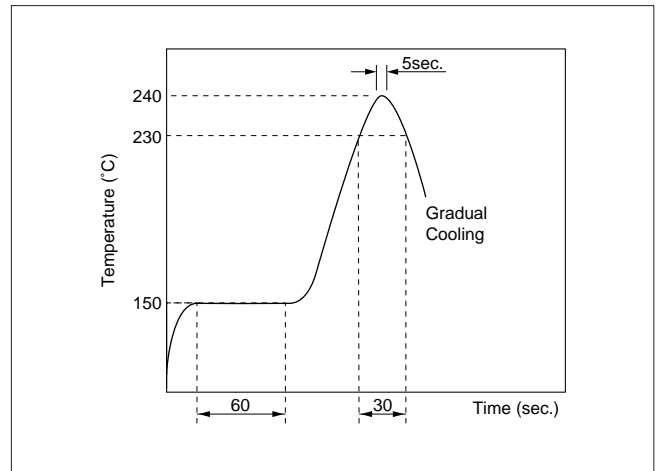

##### (2) Soldering Iron

Lead terminal is directly contacted with the tip of soldering iron of  $280 \pm 5^\circ\text{C}$  for  $3.0 \pm 0.5$  seconds.

#### 2. Wash

The component cannot be withstand washing.

### ■ Notice (handling)

1. The component may be damaged if excess mechanical stress is applied to it mounted on the printed circuit board.
2. Design layout of components on the PC board to minimize the stress imposed on the warp or flexure of the board.
3. After installing chips, if solder is excessively applied to the circuit board, mechanical stress will cause destruction resistance characteristics to lower. To prevent this, be extremely careful in determining shape and dimension before designing the circuit board diagram.
4. When the positioning claws and pick up nozzle are worn, the load is applied to the chip while positioning is concentrated to one positioning accuracy, etc. Careful checking and maintenance are necessary to prevent unexpected trouble.
5. When correcting chips with a soldering iron, the tip of the soldering iron should not directly touch the chip component. Depending on the soldering conditions, the effective area of terminations may be reduced. the use of solder containing Ag should be done to prevent the electrode erosion.
6. Do not clean or wash the component as it is not hermetically sealed.
7. In case of covering discriminator with over coat, conditions such as material of resin, cure temperature, and so on should be evaluated well.
8. Accurate test circuit values are required to measure electrical characteristics.  
It may be a cause of mis-correlation if there is any deviation, especially stray capacitance, from the test circuit in the specification.

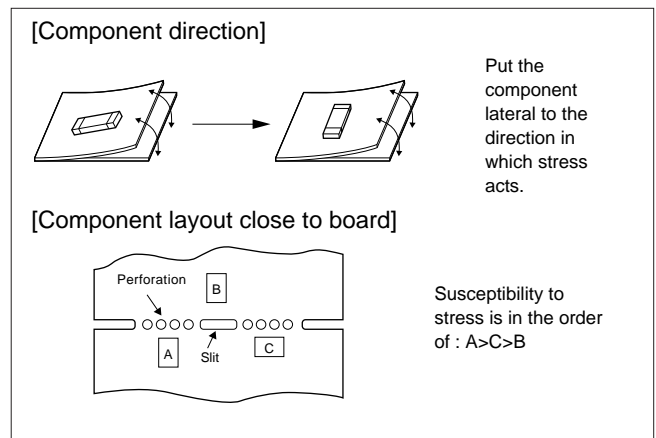

# Ceramic Filters (CERAFIL<sup>®</sup>) for FM Receivers



## Discriminators Chip Low-profile Type CDSCA Series

CDSCA10M7 series forms a resonator on a piezo electric ceramic substrate. In combination with ICs, this type obtains stable demoduration characteristics in wide bandwidth.

### ■ Features

1. Compact and high reliability and recommended for automotive applications.
2. Can be combined with various ICs. The IC is determined by the last number in the part number.
3. Stable demoduration characteristics can be obtained without adjustment.
4. Stable temperature characteristics.
5. Recommended for Pb free soldering.

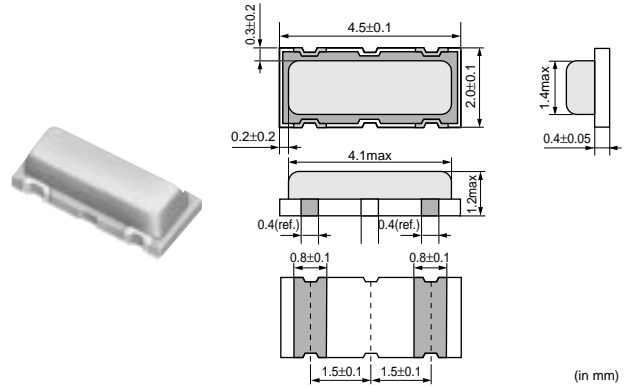

Part Number	Center Frequency (fo) (MHz)	Recovered Audio 3dB BW (kHz)	Recovered Audio Output (mV)	Distortion (%)	IC	Detection Method
<b>CDSCA10M7GF107-R0</b>	10.700 (fn)	fn±80 min.	52 min.	3.0 max.	TA31272F	Quadrature

(fn) means nominal center frequency.

### ■ Standard Land Pattern Dimensions

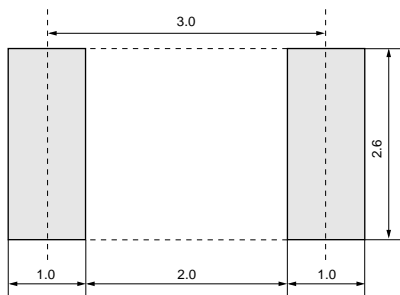

(in mm)

## ■ Test Circuit

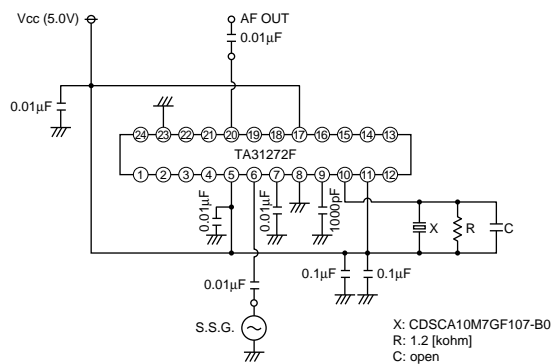

## ■ Frequency Characteristics

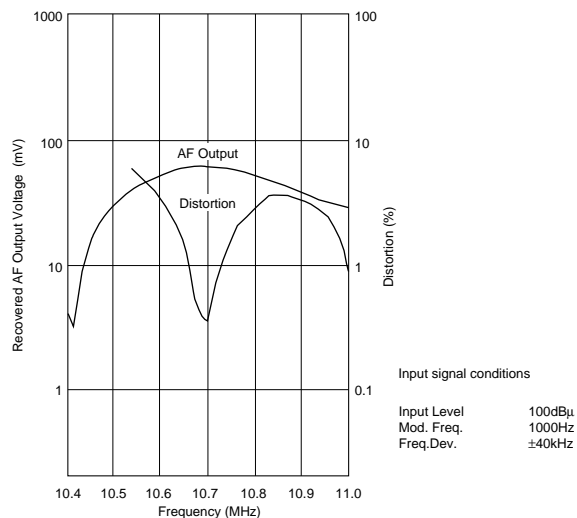

# Chip Type Discriminators CDSCA Series Notice

## ■ Notice (Soldering and Mounting)

### 1. Standard Reflow Soldering Condition

#### (1) Reflow

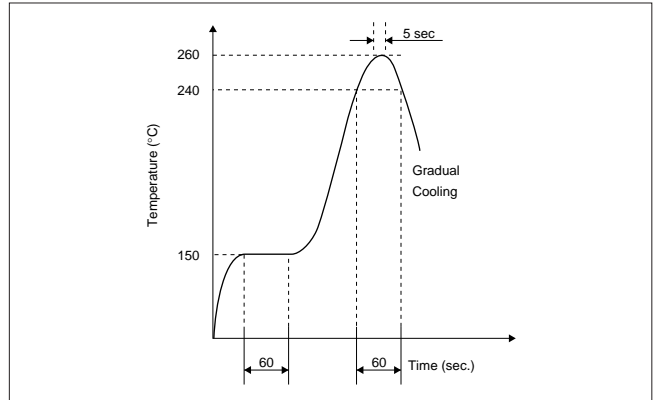

#### (2) Soldering Iron

Lead terminal is directly contacted with the tip of soldering iron of  $+280\pm 5^{\circ}\text{C}$  for  $3.0\text{ seconds}\pm 0.5\text{ seconds}$ .

### 2. Wash

The component cannot be withstand washing.

## ■ Notice (Handling)

- The component mounted on the PCB may be damaged if excess mechanical stress is applied.
- Layout the components on the PCB to minimize the stress imposed by the warp or flexure of the board.
- After installing components, if solder is excessively applied to the circuit board, mechanical stress will cause destruction resistance characteristics to be lower. To prevent this, be extremely careful in determining shape and dimension before designing the circuit board diagram.
- When the positioning claw or pick up nozzle are worn, the excess load is applied to the components while positioning or placing are performed. Careful checking and maintenance are necessary to prevent unexpected trouble.
- When correcting component's position with a soldering iron, the tip of the soldering iron should not directly touch the chip component. Depending on the soldering conditions, the effective area of terminations may be reduced. The use of solder containing Ag should be considered to prevent the electrode erosion.
- Do not clean or wash the component as it is not hermetically sealed.
- In case of overcoating the part, coating conditions such as material, curing temperature, and so on must be evaluated deeply.
- Accurate test circuit values are required to measure electrical characteristics.  
It may be a cause of mis-correlation if there is any deviation, especially stray capacitance, from the test circuit in the specification.

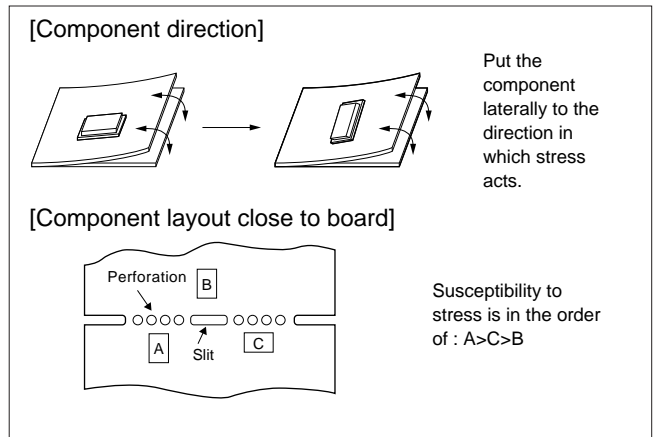

# Ceramic Filters (CERAFIL®) for FM Receivers



## Discriminators CDALA Series

CDALA10M7 series forms a resonator on a piezoelectric ceramic substrate. In combination with ICs, this type obtains stable demodulation characteristics in wide bandwidths.

### ■ Features

1. Compact and excellent mechanical strength.
2. Can be combined with various ICs. The IC is determined by the last number in the part number.
3. Stable demodulation characteristics can be obtained without adjustment.
4. The MG type for wide bandwidths and the MC type for narrow bandwidths are available.
5. Stable temperature characteristics.
6. We recommend combination : ceramic discriminator CDALA10M7 series and "CERAFIL" SFELA10M7 of the same frequency rank.



CDALA10M7G\_Series

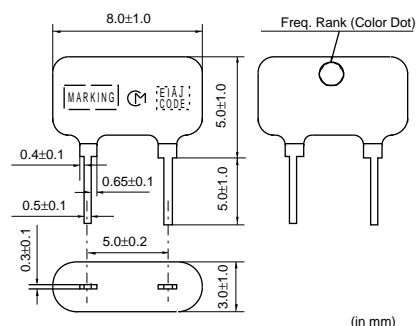

CDALA10M7C\_Series

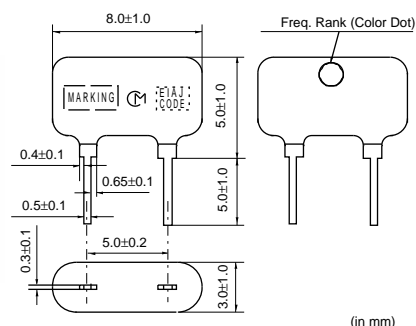

Part Number	Center Frequency (fo) (MHz)	Recovered Audio 3dB BW (kHz)	Recovered Audio Output (mV)	Distortion (%)	IC	Detection Method
CDALA10M7GA001-B0	10.700 ±30kHz	345 min.	25 min.	0.6 max.	CX20029	Quadrature
CDALA10M7GA016-B0	10.700 ±30kHz	300 min.	within 60 to 90mV	0.9 max.	TA8122F	Quadrature
CDALA10M7GA018-B0	10.700 ±30kHz	300 min.	60 min.	0.9 max.	TA8132N	Quadrature
CDALA10M7GA046-B0	10.700 ±30kHz	330 min.	280 min.	1.0 max.	LA1832	Quadrature
CDALA10M7GA048-B0	10.700 ±30kHz	400 min.	700 min.	1.0 max.	LA1835	Quadrature
CDALA10M7GA092-B0	10.700 ±30kHz	300 min.	60 min.	1.0 max.	TA2132P	Quadrature
CDALA10M7CA001-B0	10.700 ±30kHz	242 min.	35 min.	-	CX20091	Quadrature
CDALA10M7CA005A-B0	10.700 ±30kHz	100 min.	600 min.	6.0 max.	LA7770	Quadrature
CDALA10M7CA040-B0	10.700 ±30kHz	130 min.	40 min.	0.7 max.	TEA5710	Quadrature

### ■ Center Frequency Rank Code

CODE	30kHz Step	25kHz Step
D	10.64MHz±30kHz	10.650MHz±25kHz
B	10.67MHz±30kHz	10.675MHz±25kHz
A	10.70MHz±30kHz	10.700MHz±25kHz
C	10.73MHz±30kHz	10.725MHz±25kHz
E	10.76MHz±30kHz	10.750MHz±25kHz
Z	Combination A,B,C,D,E	
M	Combination A,B,C	

■ CDALA10M7GA001-B0

Test Circuit

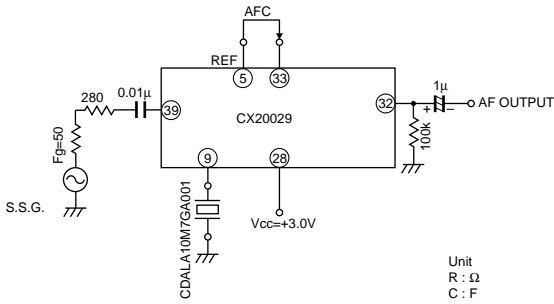

Unit  
R : Ω  
C : F

Frequency Characteristics

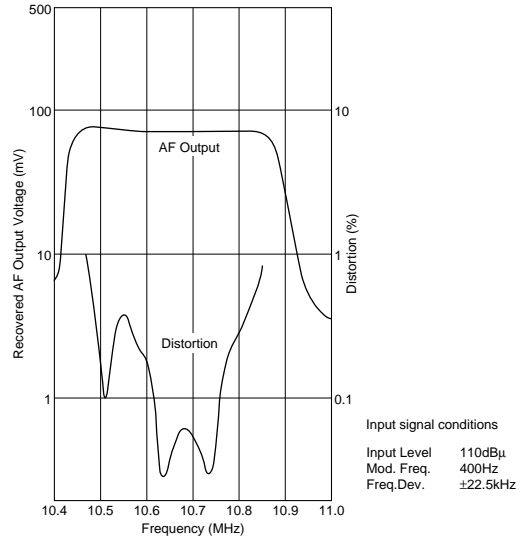

■ CDALA10M7GA016-B0

Test Circuit

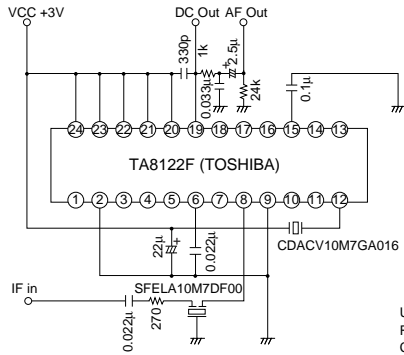

Unit  
R : Ω  
C : F

Frequency Characteristics

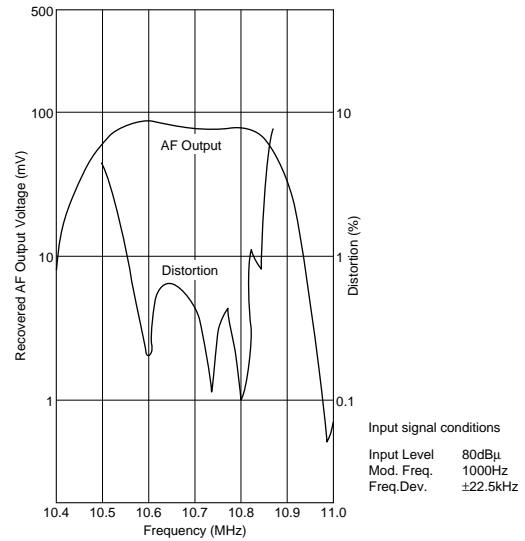

■ CDALA10M7GA018-B0

Test Circuit

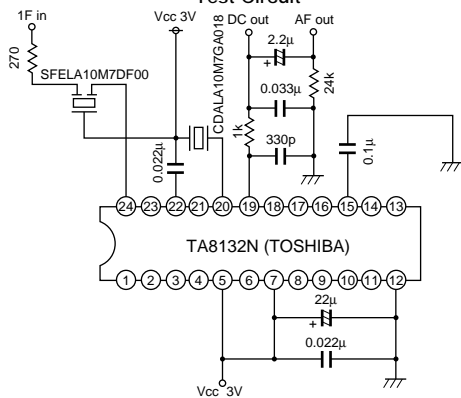

Unit  
R : Ω  
C : F

Frequency Characteristics

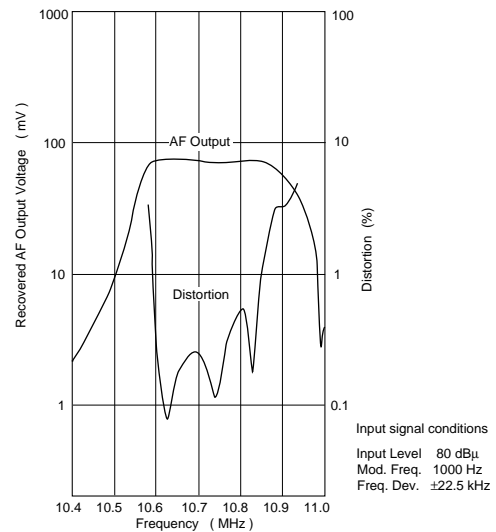

13

Continued from the preceding page.

### CDALA10M7GA046-B0

Test Circuit

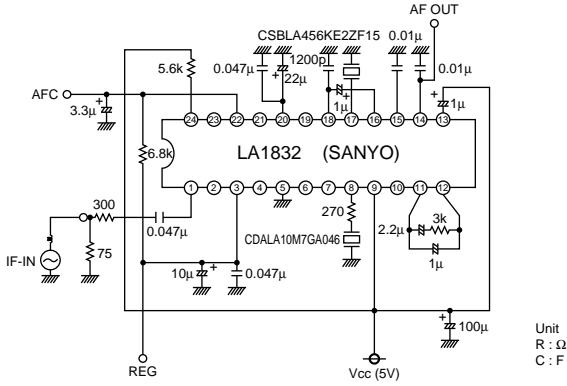

Unit  
R : Ω  
C : F

Frequency Characteristics

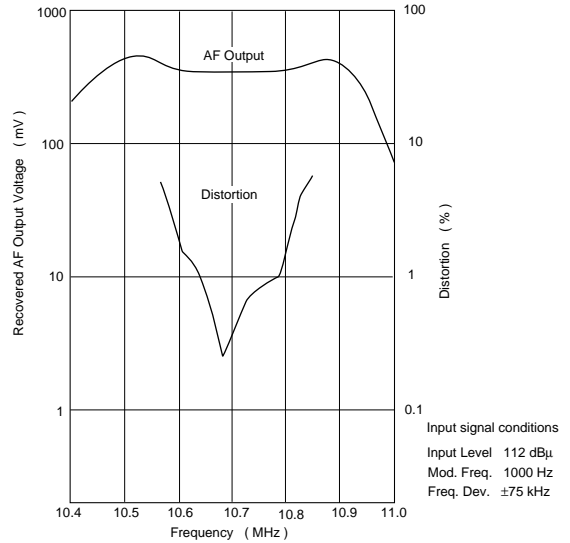

### CDALA10M7GA048-B0

Test Circuit

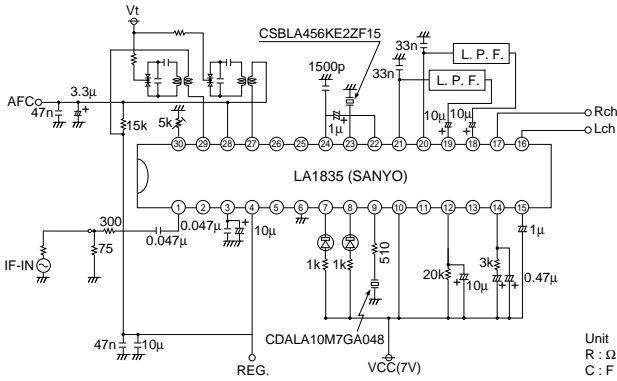

Unit  
R : Ω  
C : F

Frequency Characteristics

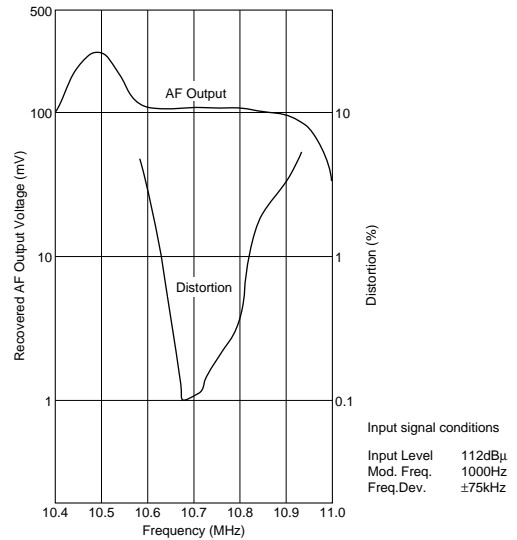

### CDALA10M7GA092-B0

Test Circuit

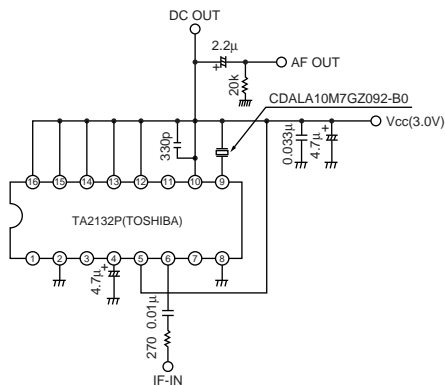

Unit  
R : Ω  
C : F

Frequency Characteristics

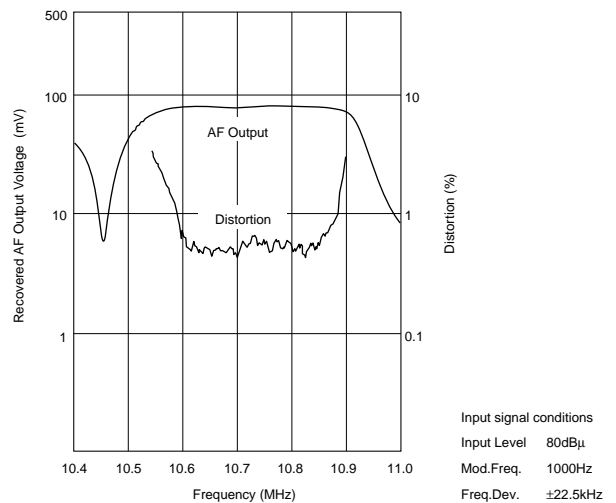



Continued from the preceding page.

**CDALA10M7CA001-B0**

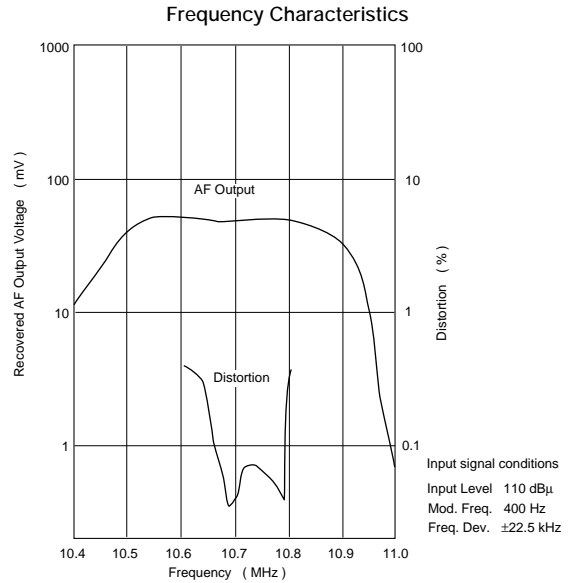
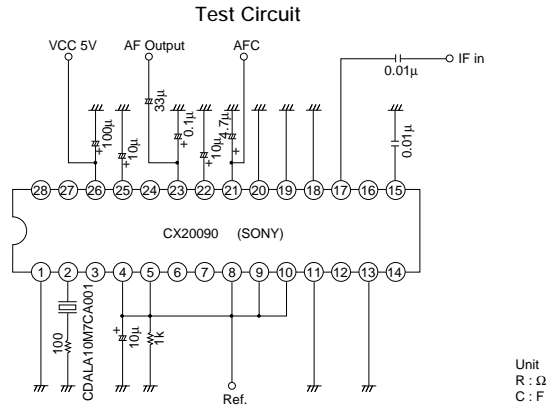

**CDALA10M7CA005A-B0**

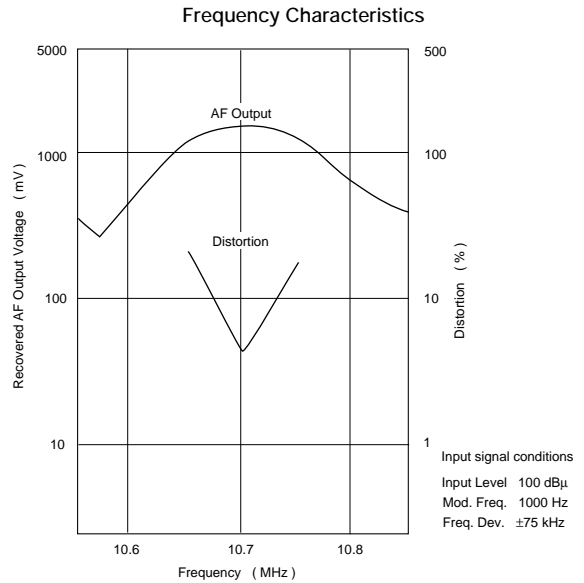
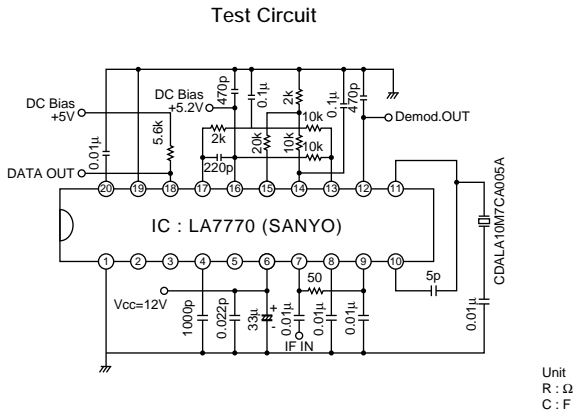

**CDALA10M7CA040-B0**

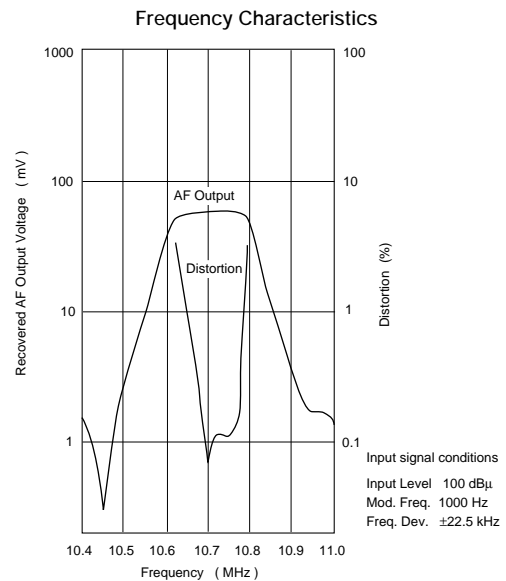
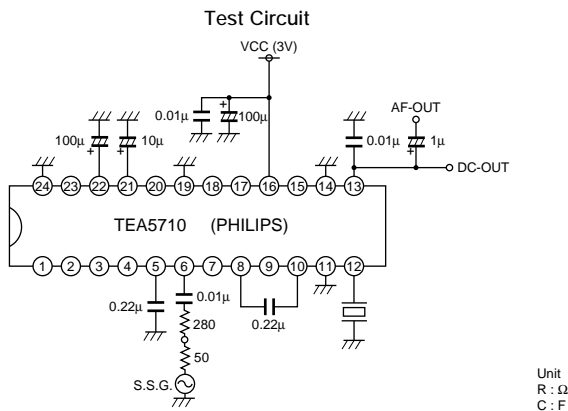

13

## Lead Type Discriminators Notice

### ■ Notice (Soldering and Mounting)

The component cannot be withstand washing.

### ■ Notice (Handling)

1. Do not use this product with bend. The component may be damaged if excess mechanical stress is applied to it mounted on the printed circuit board.
2. The component may be damaged when an excess stress will be applied.
3. All kinds of re-flow soldering must not be applied on the component.
4. Do not clean or wash the component as it is not hermetically sealed.
5. Do not use strong acidity flux, more than 0.2wt% chlorine content, in flow soldering.
6. In case of covering discriminator with over coat, conditions such as material of resin, cure temperature, and so on should be evaluated well.
7. Accurate test circuit values are required to measure electrical characteristics. It may be a cause of mis-correlation if there is any deviation, especially stray capacitance, from the test circuit in the specification.

# Packaging

## Minimum Quantity

Part Number	Taping $\phi 180\text{mm}$	Ammo Pack	Bulk
SFECV	2,000		
SFECS	2,000		
SFELA		1,500	500
SFELB		1,500	500
SFVLA		1,000	500
SFKLA		1,500	500
SFTLA			500
CDACV / CDSCA	2,000		
CDALA		1,500	500

## Chip Type CERAFIL®

SFECV Series

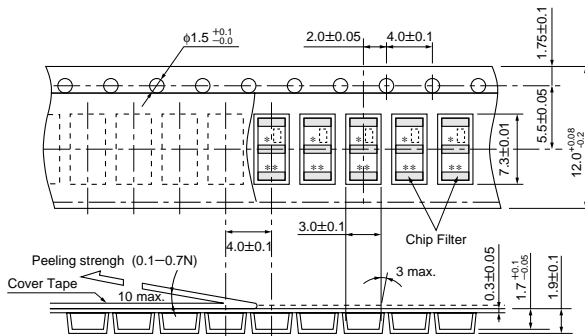

Part number marked side is always facing upside.  
The feeding holes side of cavity tape is always input terminal.

## Small Chip Type CERAFIL®

SFECS Series

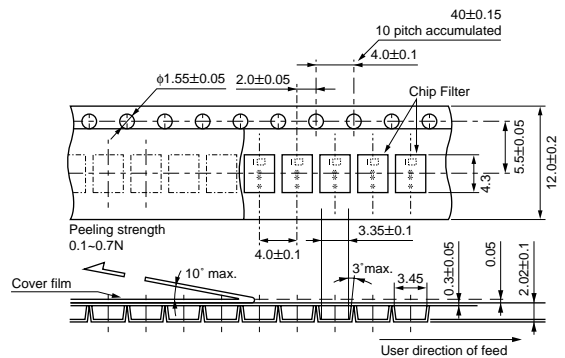

Part number marked side is always facing upside.  
The feeding holes side of cavity tape is always input terminal.

(in mm)

## Chip Type Discriminator

CDACV Series

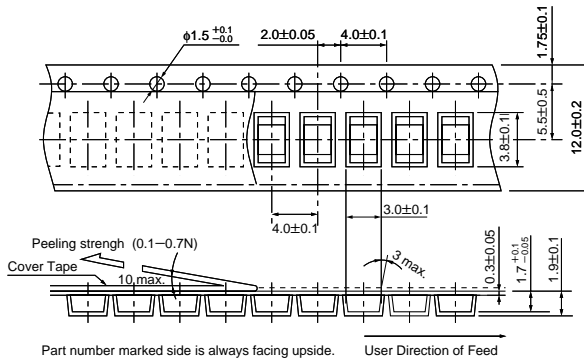

Part number marked side is always facing upside. User Direction of Feed

## Chip Type Low-Profile Type Discriminator

CDSCA Series

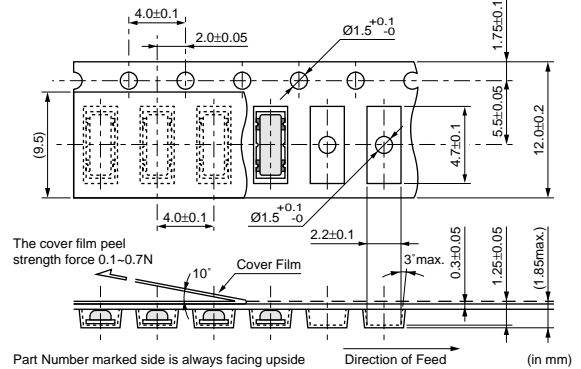

Part Number marked side is always facing upside

Continued on the following page.

## Packaging

Continued from the preceding page.

### Lead Type CERAFIL® SF\_LA Series

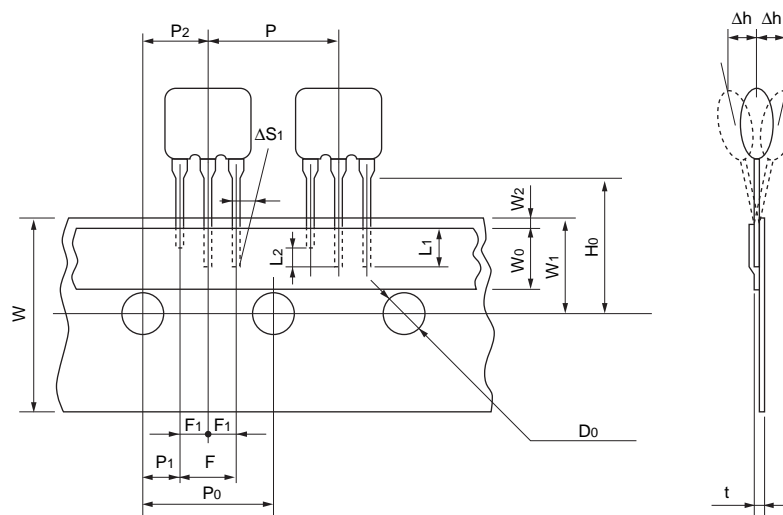

Item	Code	Dimensions	Tolerance	Remarks
Lead Length under the Hold Down Tape	L1	3.0 min.		
Length of Cat off	L2	2.0 max.		To distinguish the direction
Pitch of Components	P	12.7	±0.5	
Pitch of Sprocket Hole (1)	P0	12.7	±0.2	
Length from Hole Center to Lead	P1	3.85	±0.5	
Length from Hole Center to Component Center	P2	6.35	±0.5	
Pitch of the Terminal (1)	F	5.0	+0.5 -0.2	
Pitch of the Terminal (2)	F1	2.5	±0.2	
Slant to the Forward or Backward	Δh	0	±1.0	
Slant to the Left or Right	ΔS1	0	±1.0	
Width of Carrier Tape	W	18.0	±0.5	
Width of Hold Down Tape	W0	6.0 min.		Must not protrude to the carrier tape
Position of Sprocket Hole	W1	9.0	±0.5	
Gap of Hold Down Tape and Carrier Tape	W2	0	+0.5 -0	
Distance Between the Center of Sprocket Hole and Lead Stepper	H0	18.0	±0.5	
Diameter of Sprocket Hole	D0	ø4.0	±0.2	
Total Tape Thickness	t	0.6	±0.2	
Pitch of Sprocket Hole (2)	P020	254.0	±1.5	The pitch of 20 sprocket holes

(in mm)

Continued on the following page.

## Packaging

Continued from the preceding page.

### Lead Type Discriminator CDALA Series

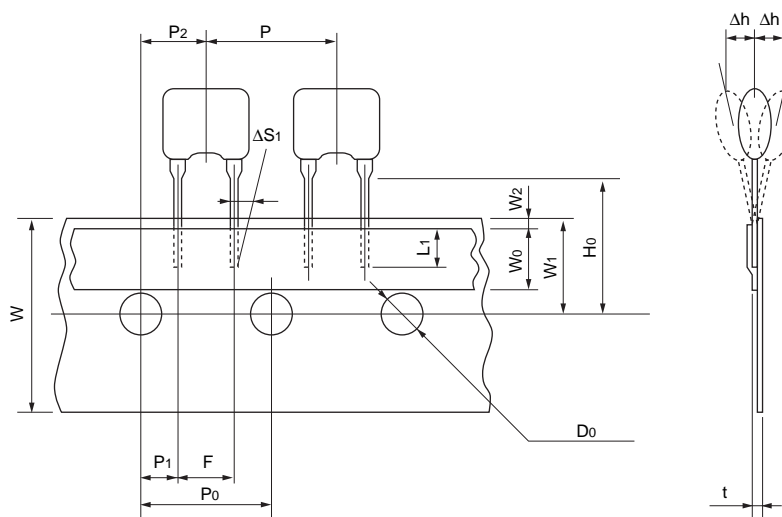

Item	Code	Dimensions	Tolerance	Remarks
Lead length under the hole down tape	L1	3.0 min.	—	
Pitch of component	P	12.7	±0.5	
Pitch of sprocket hole (1)	P0	12.7	±0.2	
Length from hole center to lead	P1	3.85	±0.5	
Length from hole center to component center	P2	6.35	±0.5	
Lead spacing	F	5.0	+0.5 -0.2	
Slant to the forward or backward	Δh	0	±1.0	
Slant to the left or right	ΔS1	0	±1.0	
Width of carrier tape	W	18.0	±0.5	
Width of hold down tape	W0	6.0 min.	—	
Position of sprocket hole	W1	9.0	±0.5	
Gap of hold down tape and Carrier tape	W2	0	+0.5 -0.0	Hold down tape doesn't exceed the carrier tape
Distance between the center of sprocket hole and lead stopper	Ho	18.0	±0.5	
Diameter of sprocket hole	Do	ø4.0	±0.2	
Total tape thickness	t	0.6	±0.2	
Pitch of sprocket hole (2)	Po20	254.0	±1.5	The pitch of 20 sprocket holes

(in mm)

## Test Circuit of Ceramic Discriminator

Part Number	IC Manufacturer	IC
CDALA10M7GA001	Sony	CX20029
CDALA10M7GA002	Sony	CX20076
CDALA10M7GA004	Rohm	BA4234L
CDALA10M7GA005	Rohm	BA4230AF
CDALA10M7GA006	Toshiba	TA7640AP
CDALA10M7GA007	Sanyo	LA1260
CDALA10M7GA008	Toshiba	TA7303P
CDALA10M7GA009	Toshiba	TA7130P
CDALA10M7GA011	Panasonic	AN7004
CDALA10M7GA012	Sony	CXA1030P
CDALA10M7GA013	Panasonic	AN7007SU
CDALA10M7GA014A	Panasonic	AN7006S
CDALA10M7GA015	Sanyo	LA1816
CDALA10M7GA016	Toshiba	TA8122AN/F
CDALA10M7GA017	Philips	TEA5591
CDALA10M7GA018	Toshiba	TA8132AN/AF
CDALA10M7GA019	Rohm	BA1440
CDALA10M7GA020	Philips	NE604
CDALA10M7GF021A	Philips	TBA229-2
CDALA10M7GA022	Sanyo	LA1810
CDALA10M7GA023	Sanyo	LA7770
CDALA10M7GF024	Philips	TDA2557
CDALA10M7GA025	Telefunken	U829B
CDALA10M7GA026	Sanyo	LA1805
CDALA10M7GA027	Sony	CXA1238
CDALA10M7GA027N	Sony	CXA1238N
CDALA10M7GA028	Telefunken	U2501B
CDALA10M7GA029	Philips	TBA120U
CDALA10M7GA030	Philips	TEA5592
CDALA10M7GA031	Toshiba	TA2003
CDALA10M7GA032	Sony	CXA1343M
CDALA10M7GA033	Toshiba	TA2007N
CDALA10M7GA034V	Telefunken	U4490B
CDALA10M7GA035	Philips	TEA5594
CDALA10M7GA036	Toshiba	TA2029
CDALA10M7GA037	Sanyo	LA1830
CDALA10M7GA038	Siemens	TDA6160X
CDALA10M7GA039	Toshiba	TA8186
CDALA10M7GA040	Philips	TEA5710
CDALA10M7GA041	Rohm	BA4220
CDALA10M7GA042	Philips	SA605
CDALA10M7GA043	Sanyo	LA1831
CDALA10M7GA044	Siemens	TDA6160-2X
CDALA10M7GA045	Toshiba	TA2008A/AN
CDALA10M7GA046	Sanyo	LA1832/M
CDALA10M7GA047	Philips	SA626
CDALA10M7GA048	Sanyo	LA1835/M
CDALA10M7GA049	Motorola	MC13156
CDALA10M7GA050	Toshiba	TA2022
CDALA10M7GA051	Siemens	TDA1576T
CDALA10M7GA052	Motorola	MC13173
CDALA10M7GA053	Panasonic	AN7232
CDALA10M7GA054	Sony	CXA1376AM
CDALA10M7GA055	Philips	TEA5712T
CDALA10M7GA056	NEC	μPC1391M
CDALA10M7GA057	Toshiba	TA2057
CDALA10M7GA058	Toshiba	TA2046
CDALA10M7GA059	Samsung	KA2244
CDALA10M7GA060	Rohm	BA1448
CDALA10M7GA061	Philips	TEA5762/5757

Part Number	IC Manufacturer	IC
CDALA10M7GF062	Toko	TK14581
CDALA10M7GA063	Samsung	KA2292
CDALA10M7GA064	Samsung	KA2295
CDALA10M7GA065	Samsung	KA2298
CDALA10M7GA066	Rohm	BA4110
CDALA10M7GA067	Rohm	BA4240L
CDALA10M7GA068	Sony	CXA1991N
CDALA10M7GA069	Sony	CXA1538M/N/S
CDALA10M7GA070	Sanyo	LA1150
CDALA10M7GA071	Toshiba	TA7765
CDALA10M7GF072	Toshiba	TA31161
CDALA10M7GA073	Motorola	MC13158
CDALA10M7GA075	Sony	CXA1611
CDALA10M7GA076	Sony	CXA3067M
CDALA10M7GA077	Toshiba	TA2111
CDALA10M7GA078	Sony	CX1691M
CDALA10M7GA079	Sanyo	LA1838/M
CDALA10M7GA080	Toshiba	TA2104AFN
CDALA10M7GA080A	Toshiba	TA2104F
CDALA10M7GA081	Telefunken	U4313B
CDALA10M7GA082	Toshiba	TA2099N
CDALA10M7GA083	Sanyo	LA1827
CDALA10M7GA084	Rohm	BH4126FV
CDALA10M7GA085	Philips	SA639
CDALA10M7GA086	Sanyo	LA1833
CDALA10M7GA087	Motorola	MC3363
CDALA10M7GA088	Toshiba	TA8721ASN
CDALA10M7GA089	Samsung	KA22425
CDALA10M7GA090	Samsung	KA22901
CDALA10M7GA091	Samsung	KA2297
CDALA10M7GA092	Toshiba	TA2132
CDALA10M7GA092D	Toshiba	TA2132BP
CDALA10M7GA093	Sony	CXA1111
CDALA10M7GA094	Sanyo	LA1822
CDALA10M7GA095	Temec	U2765B
CDALA10M7GA096	Philips	SA636DK
CDALA10M7GA097	Matsushita	AN6138SH
CDALA10M7GA098	Philips	CAA3220TS
CDALA10M7GA100	Toshiba	TA2149N
CDALA10M7GA100A	Toshiba	TA2149AN
CDALA10M7GA101	Sanyo	LA1823
CDALA10M7GA102	Toshiba	TA2142FN
CDALA10M7GA103	Samsung	KB22902
CDALA10M7GA104	Rfmd	RF2925
CDALA10M7GA105A	Philips	TEA5757HL
CDALA10M7GA106	Fujitsu	MB15G611
CDALA10M7GF107	Toshiba	TA31272FN
CDALA10M7GF108A	Sanyo	LA1225M
CDALA10M7GF109	Toko	TK14588
CDALA10M7GA110	Dspg	DS9RF21

Part Number	IC Manufacturer	IC
CDALA10M7CA001	Sony	CX20091
CDALA10M7CA002	Toshiba	TA7687P/F
CDALA10M7CA004A	Motorola	MC3356P
CDALA10M7CA005A	Sanyo	LA7770
CDALA10M7CA006	Philips	TEA5591
CDALA10M7CA009	Toshiba	TA7640AP
CDALA10M7CA040	Philips	TEA5710

## Example of Applied Circuit

### LA1140(Automotive Radio)

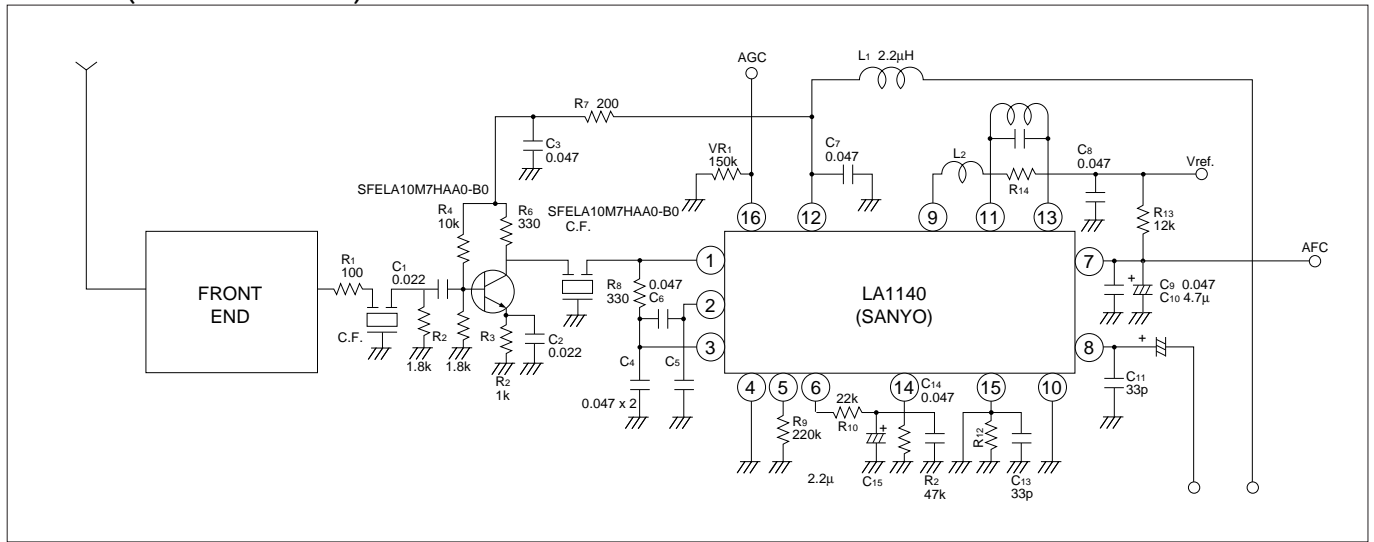

### CXA1019M(Radio)

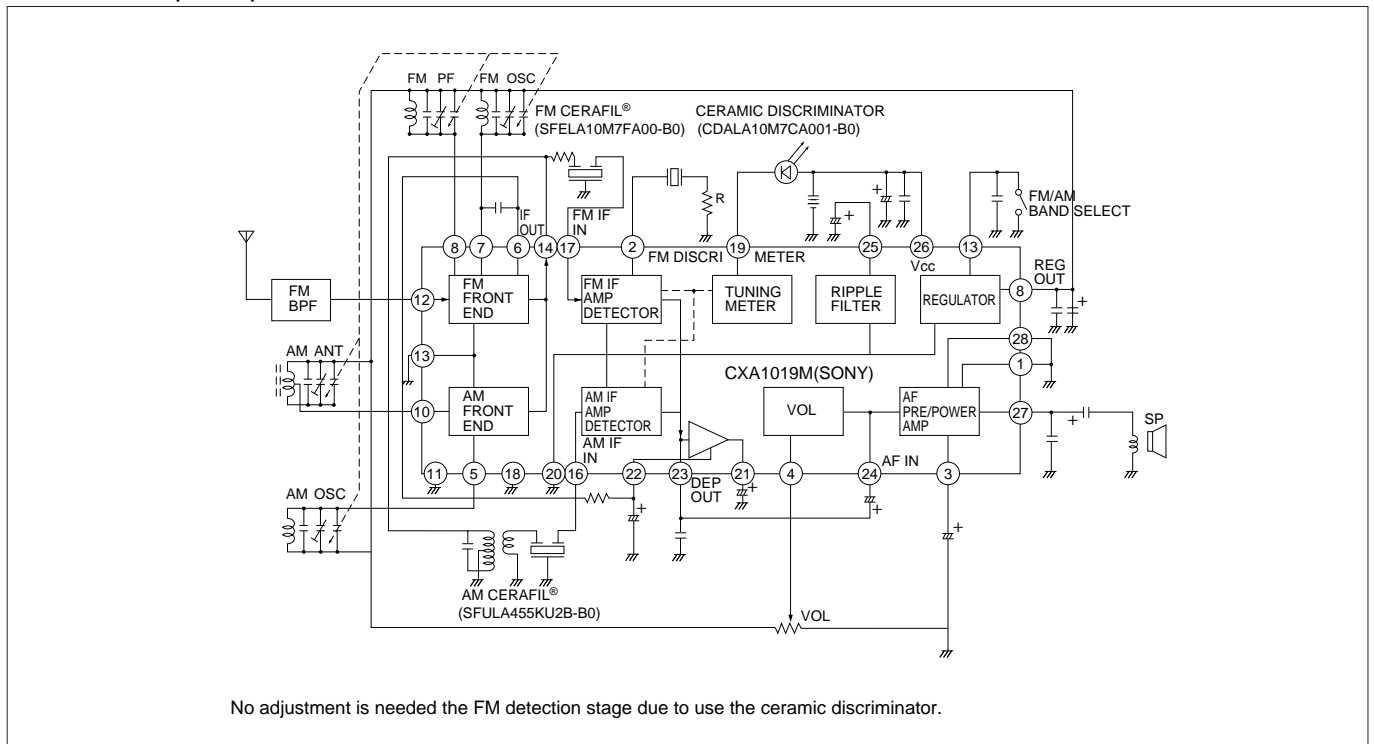

Continued on the following page.

## Example of Applied Circuit

Continued from the preceding page.

### TA8122F(Radio)

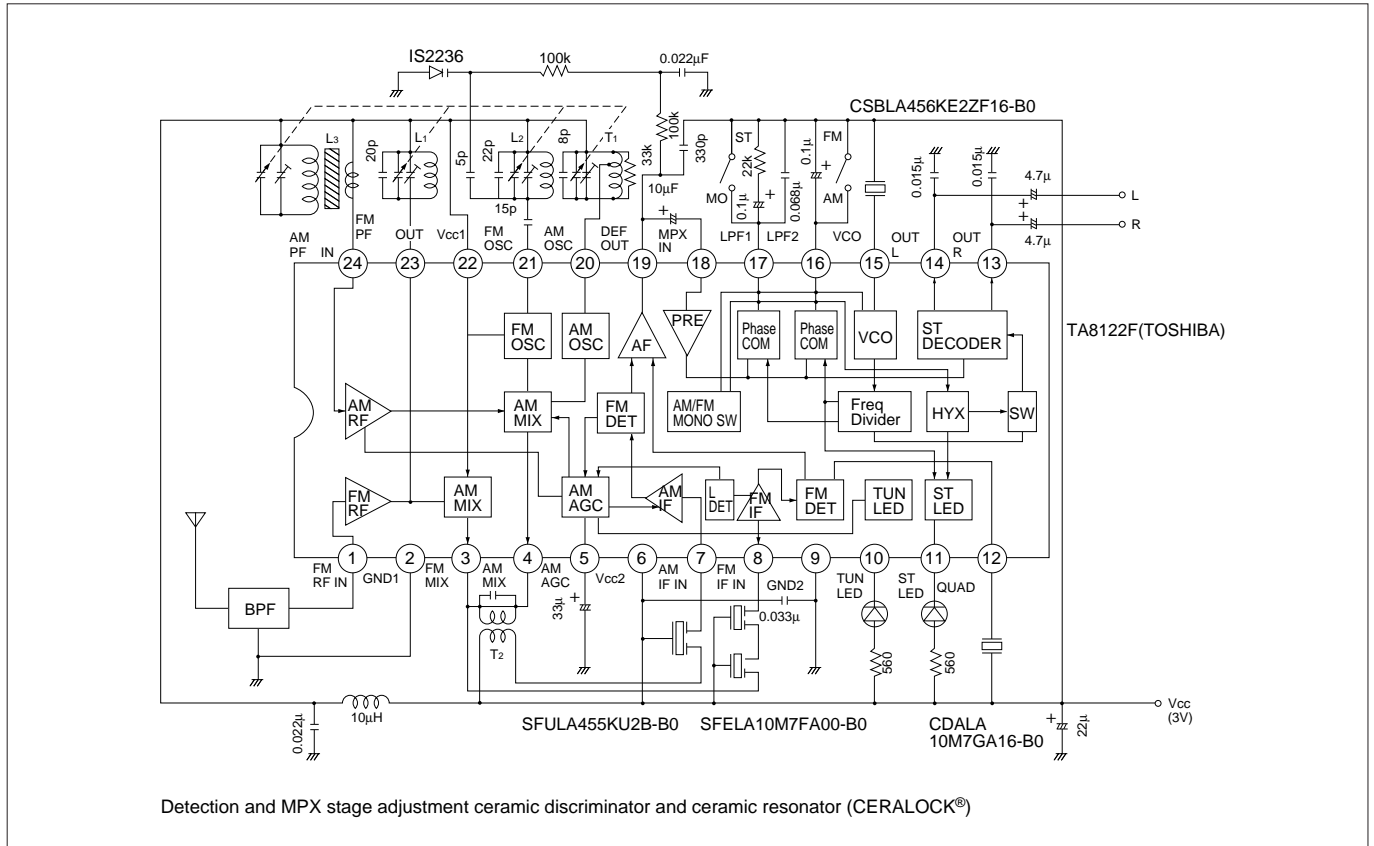



**⚠ Note:**

1. Export Control

⟨For customers outside Japan⟩

Murata products should not be used or sold for use in the development, production, stockpiling or utilization of any conventional weapons or mass-destructive weapons (nuclear weapons, chemical or biological weapons, or missiles), or any other weapons.

⟨For customers in Japan⟩

For products which are controlled items subject to the "Foreign Exchange and Foreign Trade Law" of Japan, the export license specified by the law is required for export.

2. Please contact our sales representatives or product engineers before using our products listed in this catalog for the applications listed below which require especially high reliability for the prevention of defects which might directly cause damage to the third party's life, body or property, or when intending to use one of our products for other applications than specified in this catalog.

- ① Aircraft equipment
- ② Aerospace equipment
- ③ Undersea equipment
- ④ Power plant equipment
- ⑤ Medical equipment
- ⑥ Transportation equipment (vehicles, trains, ships, etc.)
- ⑦ Traffic signal equipment
- ⑧ Disaster prevention / crime prevention equipment
- ⑨ Data-processing equipment
- ⑩ Application of similar complexity and/or reliability requirements to the applications listed in the above

3. Product specifications in this catalog are as of May 2001. They are subject to change or our products in it may be discontinued without advance notice. Please check with our sales representatives or product engineers before your ordering. If there are any questions, please contact our sales representatives or product engineers.

4. Please read CAUTION and Notice in this catalog for safety. This catalog has only typical specifications. Therefore you are requested to approve our product specification or to transact the approval sheet for product specification, before your ordering.

5. Please note that unless otherwise specified, we shall assume no responsibility whatsoever for any conflict or dispute that may occur in connection with the effect of our and/or third party's intellectual property rights and other related rights in consideration of your using our products and/or information described or contained in our catalogs. In this connection, no representation shall be made to the effect that any third parties are authorized to use the rights mentioned above under licenses without our consent.

6. None of ozone depleting substances (ODS) under the Montreal Protocol is used in manufacturing process of us.