



CEP658N/CEB658N CEF658N

N-Channel Enhancement Mode Field Effect Transistor

PRELIMINARY

FEATURES

Type	V _{DSS}	R _{DS(ON)}	I _D	@V _{GS}
CEP658N	180V	0.22Ω	16A	10V
CEB658N	180V	0.22Ω	16A	10V
CEF685N	180V	0.22Ω	16A ^d	10V

- Super high dense cell design for extremely low R_{DS(ON)}.
- High power and current handing capability.
- Lead free product is acquired.

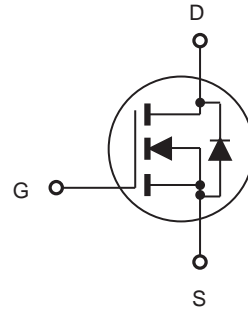
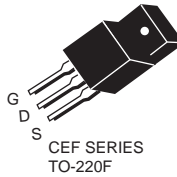

ABSOLUTE MAXIMUM RATINGS $T_C = 25^\circ\text{C}$ unless otherwise noted

Parameter	Symbol	Limit		Units
		TO-220/263	TO-220F	
Drain-Source Voltage	V _{DS}	180		V
Gate-Source Voltage	V _{GS}	±20		V
Drain Current-Continuous	I _D	16	16 ^d	A
Drain Current-Pulsed ^a	I _{DM} ^e	64	64 ^d	A
Maximum Power Dissipation @ T _C = 25°C - Derate above 25°C	P _D	125	40	W
		1.0	0.32	W/°C
Operating and Store Temperature Range	T _J , T _{stg}	-55 to 150		°C

Thermal Characteristics

Parameter	Symbol	Limit		Units
Thermal Resistance, Junction-to-Case	R _{θJC}	1.0	3.1	°C/W
Thermal Resistance, Junction-to-Ambient	R _{θJA}	62.5	65	°C/W

This is preliminary information on a new product in development now .
Details are subject to change without notice .

Rev 2. 2006.Oct
<http://www.cetsemi.com>



CEP658N/CEB658N CEF658N

Electrical Characteristics $T_C = 25^\circ\text{C}$ unless otherwise noted

4

Parameter	Symbol	Test Condition	Min	Typ	Max	Units
Off Characteristics						
Drain-Source Breakdown Voltage	BV_{DSS}	$V_{GS} = 0V, I_D = 250\mu A$	180			V
Zero Gate Voltage Drain Current	I_{DSS}	$V_{DS} = 160V, V_{GS} = 0V$			25	μA
Gate Body Leakage Current, Forward	I_{GSSF}	$V_{GS} = 20V, V_{DS} = 0V$			100	nA
Gate Body Leakage Current, Reverse	I_{GSSR}	$V_{GS} = -20V, V_{DS} = 0V$			-100	nA
On Characteristics^b						
Gate Threshold Voltage	$V_{GS(th)}$	$V_{GS} = V_{DS}, I_D = 250\mu A$	2		4	V
Static Drain-Source On-Resistance	$R_{DS(on)}$	$V_{GS} = 10V, I_D = 16A$		0.2	0.22	Ω
Dynamic Characteristics^c						
Forward Transconductance	g_{FS}	$V_{DS} = 10V, I_D = 9A$		10.8		S
Input Capacitance	C_{iss}	$V_{DS} = 25V, V_{GS} = 0V, f = 1.0\text{ MHz}$		760		pF
Output Capacitance	C_{oss}			155		pF
Reverse Transfer Capacitance	C_{rss}			60		pF
Switching Characteristics^c						
Turn-On Delay Time	$t_{d(on)}$	$V_{DD} = 100V, I_D = 11A, V_{GS} = 10V, R_{GEN} = 9.1\Omega$		17	35	ns
Turn-On Rise Time	t_r			32	60	ns
Turn-Off Delay Time	$t_{d(off)}$			90	170	ns
Turn-Off Fall Time	t_f			38	75	ns
Total Gate Charge	Q_g	$V_{DS} = 160V, I_D = 16A, V_{GS} = 10V$		25	32	nC
Gate-Source Charge	Q_{gs}			5.4		nC
Gate-Drain Charge	Q_{gd}			12		nC
Drain-Source Diode Characteristics and Maximum Ratings						
Drain-Source Diode Forward Current	I_S^f				16	A
Drain-Source Diode Forward Voltage ^b	V_{SD}	$V_{GS} = 0V, I_S = 16A^g$			1.5	V
Notes : a.Repetitive Rating : Pulse width limited by maximum junction temperature . b.Pulse Test : Pulse Width $\leq 300\mu s$, Duty Cycle $\leq 2\%$. c.Guaranteed by design, not subject to production testing. d.Limited only by maximum temperature allowed . e .Pulse width limited by safe operating area . f .Full package $I_{S(max)} = 9.8A$.						



CEP658N/CEB658N CEF658N

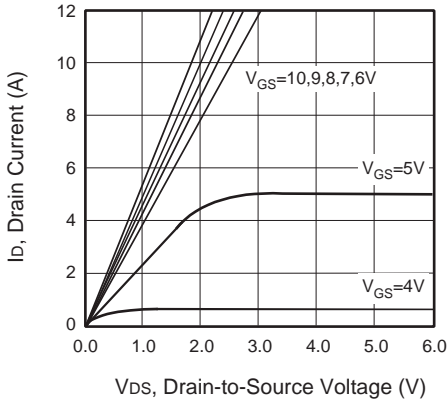

Figure 1. Output Characteristics

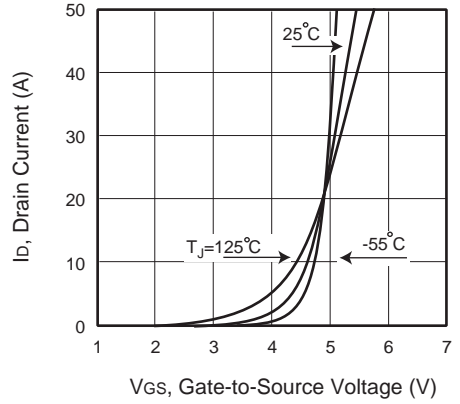

Figure 2. Transfer Characteristics

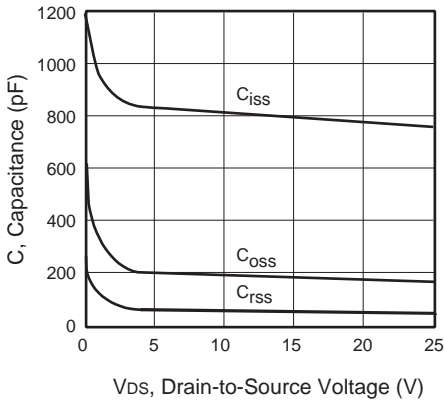

Figure 3. Capacitance

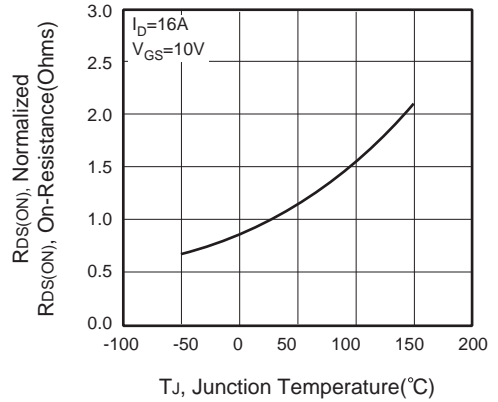

Figure 4. On-Resistance Variation with Temperature

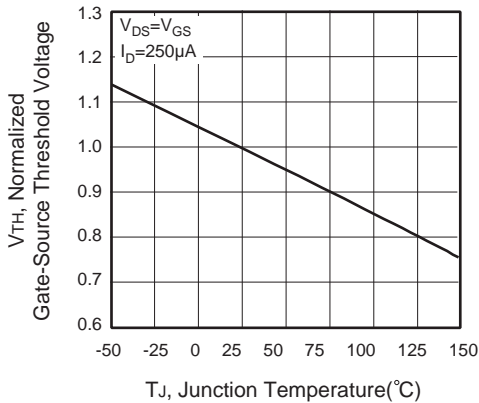

Figure 5. Gate Threshold Variation with Temperature

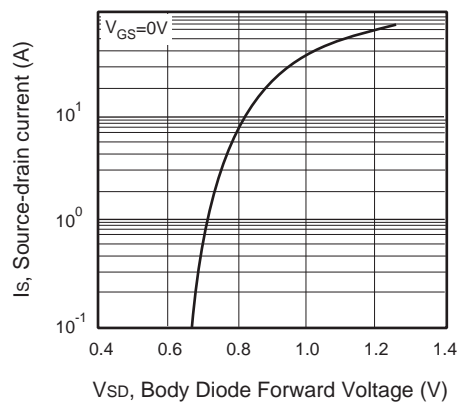

Figure 6. Body Diode Forward Voltage Variation with Source Current



CEP658N/CEB658N CEF658N

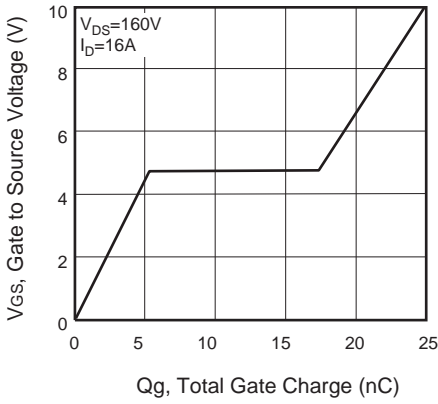

Figure 7. Gate Charge

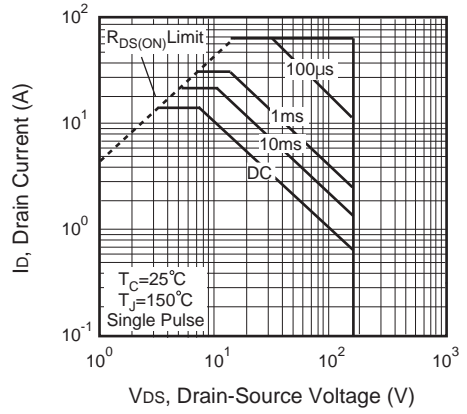

Figure 8. Maximum Safe Operating Area

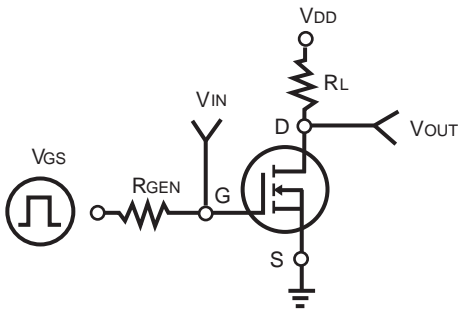

Figure 9. Switching Test Circuit

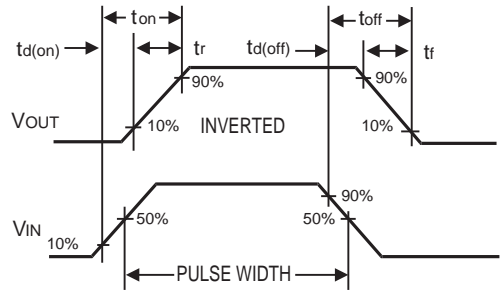

Figure 10. Switching Waveforms

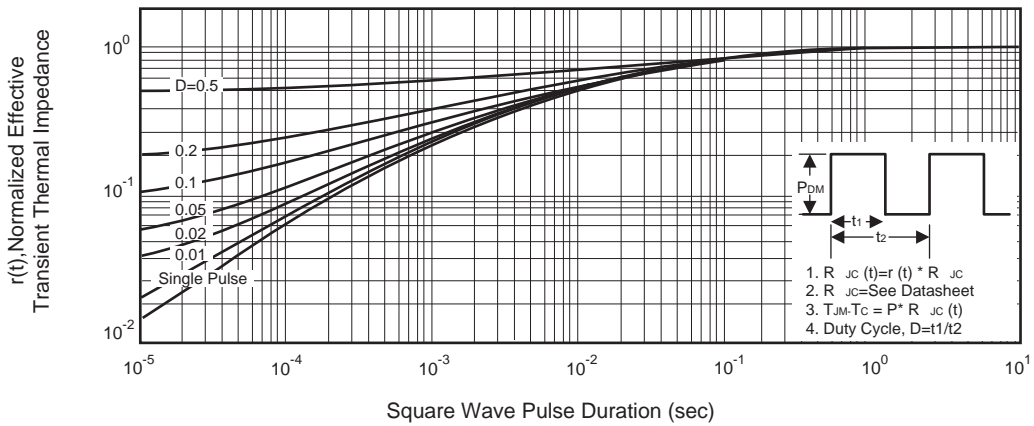

Figure 11. Normalized Thermal Transient Impedance Curve