

CFRC301 Thru CFRC307

Reverse Voltage: 50 - 1000 Volts
Forward Current: 3.0 Amp



Features

- Ideal for surface mount applications
- Easy pick and place
- Plastic package has Underwriters Lab. flammability classification 94V-0
- Fast recovery time: 150 - 500 nS
- Low leakage current

Mechanical data

- Case: JEDEC DO-214AB molded plastic
- Terminals: solderable per MIL-STD-750, method 2026
- Polarity: Color band denotes cathode end
- Mounting position: Any
- Approx. Weight: 0.21 gram

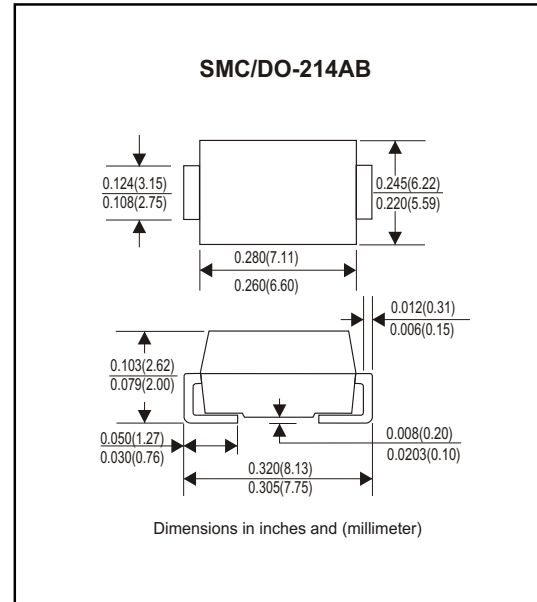

Maximum Ratings and Electrical Characteristics

Parameter	Symbol	CFRC 301	CFRC 302	CFRC 303	CFRC 304	CFRC 305	CFRC 306	CFRC 307	Unit
Max. Repetitive Peak Reverse Voltage	V _{RRM}	50	100	200	400	600	800	1000	V
Max. DC Blocking Voltage	V _{DC}	50	100	200	400	600	800	1000	V
Max. RMS Voltage	V _{RMS}	35	70	140	280	420	560	700	V
Peak Surge Forward Current 8.3ms single halfsine-wave superimposed on rate load (JEDEC method)	I _{FSM}	100							A
Max. Average Forward Current	I _o	3.0							A
Max. Instantaneous Forward Current at 3.0 A	V _F	1.3							V
Reverse Recovery Time	T _{rr}	100			250		500		nS
Max. DC Reverse Current at Rated DC Blocking Voltage Ta=25°C Ta=100°C	I _R					5.0 50		uA	
Max. Thermal Resistance (Note 1)	R _{θJA}	50							°C/W
Operating Junction Temperature	T _j	-55 to +150							°C
Storage Temperature	T _{STG}	-55 to +150							°C

Note 1: Thermal resistance from junction to ambient.

Rating and Characteristic Curves (CFRC301 Thru CFRC307)

Fig. 1 - Reverse Characteristics

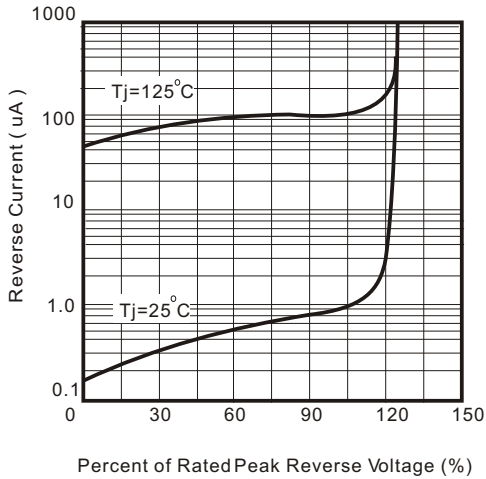

Fig.2 - Forward Characteristics

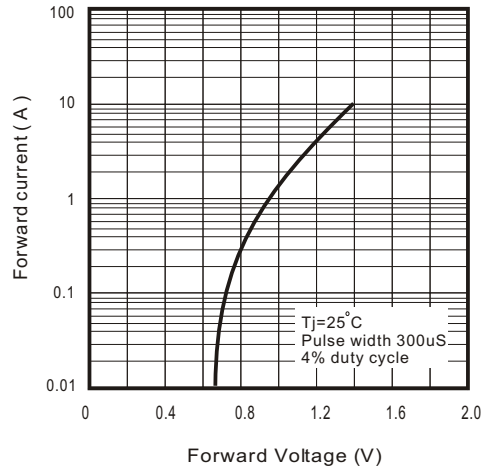

Fig. 3 - Junction Capacitance

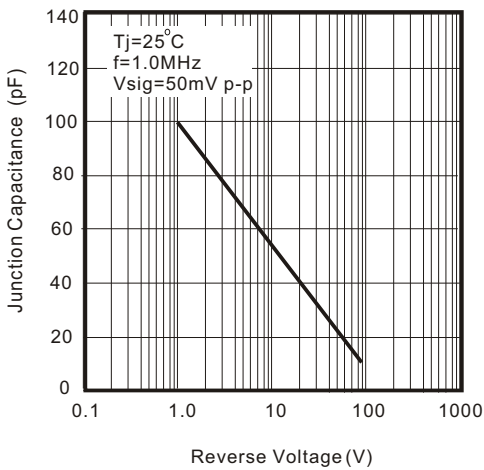

Fig. 4 - Non Repetitive Forward Surge Current

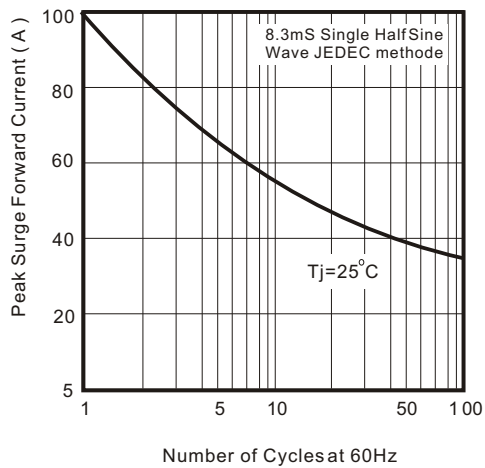
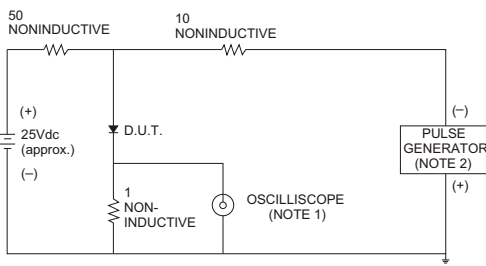

Fig. 5 - Test Circuit Diagram and Reverse Recovery Time Characteristics



NOTES: 1. Rise Time= 7ns max., Input Impedance= 1 megohm, 22pF.
2. Rise Time= 10ns max., Source Impedance= 50 ohms.

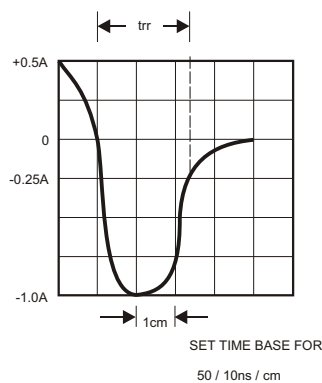

Fig. 6 - Current Derating Curve

