

DC-6.0 GHz InGaP HBT, MMIC or Packaged, Matched Gain Block Amplifier



September 2006 - Rev 17-Sep-06

CGB7010-SC (-BD)
RoHS

Features

- ✕ 35.5 dBm Output IP3 @ 850 MHz
- ✕ 3.2 dB Noise Figure @ 850 MHz
- ✕ 21.5 dB Gain @ 850 MHz
- ✕ 20.0 dBm P1dB @ 850 MHz
- ✕ Low Performance Variation Over Temperature
- ✕ Low Cost: Die Form or SOT-89 Package
- ✕ 100% DC On-Wafer Testing
- ✕ ESD Protection on All Die: >1000V HBM
- ✕ Low Thermal Resistance: <80°C/Watt

Functional Block Diagram (SOT-89)

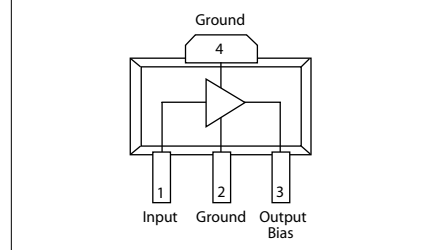

Description

The CGB7010-SC (-BD) is a Darlington Configured, high dynamic range, utility gain block amplifier. Designed for applications operating within the DC to 6.0 GHz frequency range, Mimix's broadband, cascadable, gain block amplifiers are ideal solutions for transmit, receive and IF applications.

These MMIC amplifiers are available in bare die form or an industry standard SOT-89 package. Mimix's InGaP HBT technology and an industry low thermal resistance offers a thermally robust and reliable gain block solution.

The InGaP HBT die have extra pads to enable thorough DC testing. This unique test capability and the inclusion of ESD protection on all die, significantly enhances the quality, reliability and ruggedness of these products.

With a single bypass capacitor, optional RF choke and two DC blocking capacitors, this gain block amplifier offers significant ease of use in a broad range of applications.

Absolute Maximum Ratings

Max Device Voltage	+6.0 V
Max Device Current	130 mA
Max Device Dissipated Power	0.65 W
RF Input Power	+17 dBm
Storage Temperature	-55°C to 150°C
Junction Temperature	150°C
Operating Temperature	-40°C to +85°C
Thermal Resistance	80° C/W
EDS (HBM)	1000 V

Operation of this device above any of these parameters may cause permanent damage.

Applications

- ✕ PA Driver Amp, IF Amp, LO Buffer Amp
- ✕ Cellular, PCS, GSM, UMTS
- ✕ Wireless Data and SATCOM
- ✕ Transmit and Receive Functions
- ✕ CATV

Electrical Characteristics

Unless otherwise specified, the following specifications are guaranteed at room temperature in a Mimix test fixture.

Parameter	Temperature (°C)	850 MHz			1950 MHz			2400 MHz			3500 MHz			Units
		Min.	Typ.	Max.	Min.	Typ.	Max.	Min.	Typ.	Max.	Min.	Typ.	Max.	
Small Signal Gain	+25	20.3	21.5	22.7	17.8	19.0	20.2	16.8	18.0	19.8		16.5		dB
	-40 to +85	20.1	21.5	22.9	17.6	19.0	20.4	16.6	18.0	19.4		16.5		dB
Output P1dB	+25	19.0	20.0		18.3	19.3		18.2	18.2			15.5		dBm
	-40 to +85	18.7	20.0		18.0	19.3		16.9	18.2			15.5		dBm
Output IP3	+25	34.0	35.5		32.0	33.5		30.5	32.0			29.0		dBm
	-40 to +85	33.5	35.5		31.0	33.5		29.5	32.0			29.0		dBm
Noise Figure	+25		3.2	4.0		3.5	4.3		3.6	4.4		3.7		dB
	-40 to +85		3.2	4.2		3.5	4.5		3.6	4.6		3.7		dB
Operating Current	+25	71	75	79	71	75	79	71	75	79		75		mA
	-40 to +85	66	75	83	66	75	83	66	75	83		75		mA
Input Return Loss	+25	13	17		11	15		12	15			11		dB
	-40 to +85	12	17		10	15		11	15			10		dB
Output Return Loss	+25	18	25		12	17		13	16			13		dB
	-40 to +85	17	25		11	17		12	16			12		dB
Pout @ -45 dBc, ACP IS-95, 9 Forward Channels	+25		14.0			13.5								dBm
	-40 to +85		13.5			13.0								dBm

Notes: 1. Test Conditions in Mimix eval board, Vs = 8 V, Id = 75 mA Typ., Rbias = 39 Ω, Zs = Zl = 50 Ω, OIP3 tone spacing = 1 MHz, Pout per tone = 3 dBm.
2. Values reflect performance in recommended application circuit.

DC-6.0 GHz InGaP HBT, MMIC or Packaged, Matched Gain Block Amplifier



September 2006 - Rev 17-Sep-06

CGB7010-SC (-BD)
RoHS

Typical S-Parameter and Noise Performance

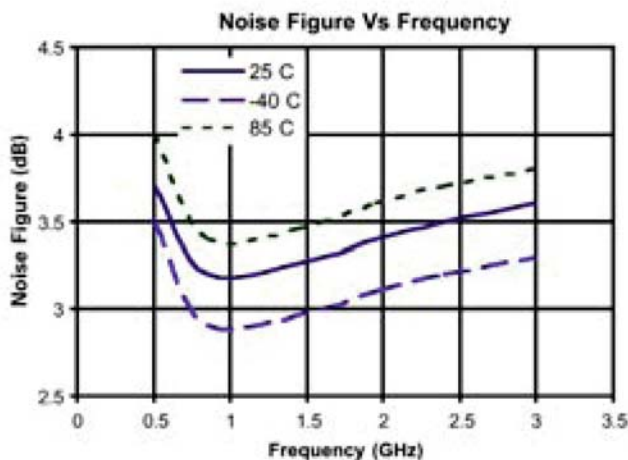
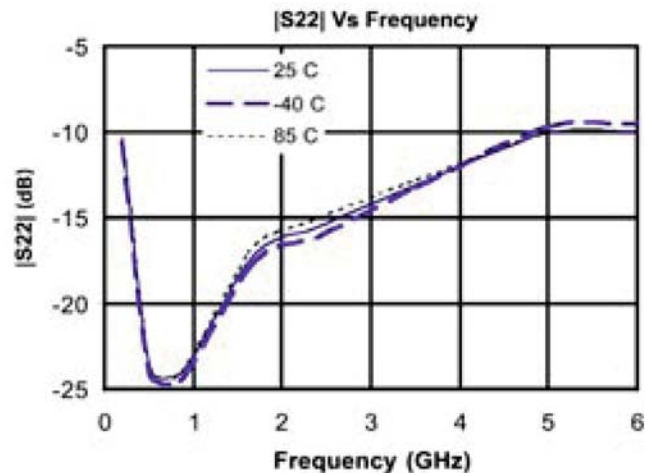
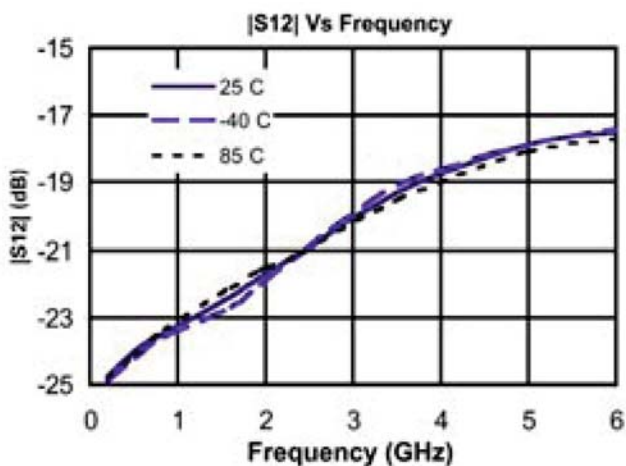
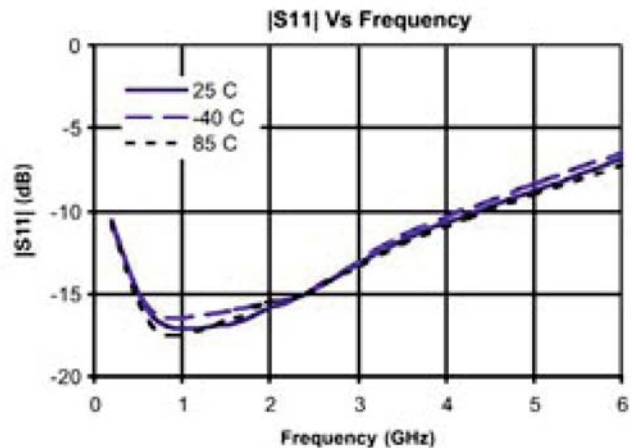
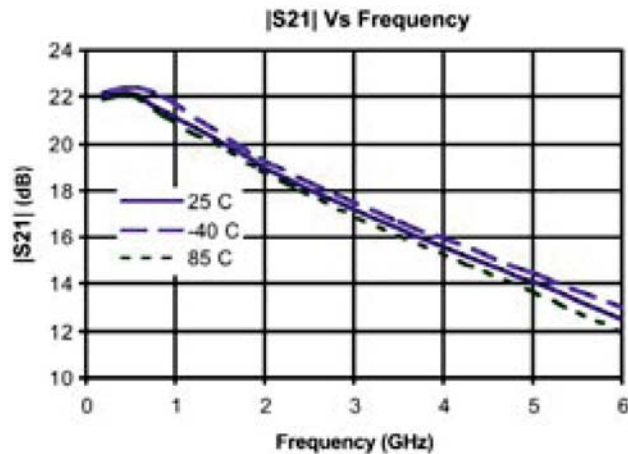

DC-6.0 GHz InGaP HBT, MMIC or Packaged, Matched Gain Block Amplifier



September 2006 - Rev 17-Sep-06

CGB7010-SC (-BD)
RoHS

Typical Power and Linearity Performance

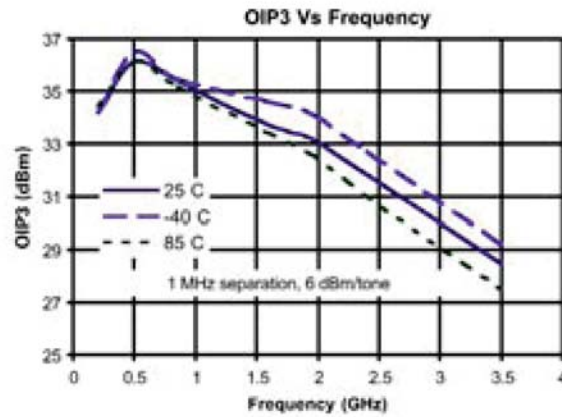
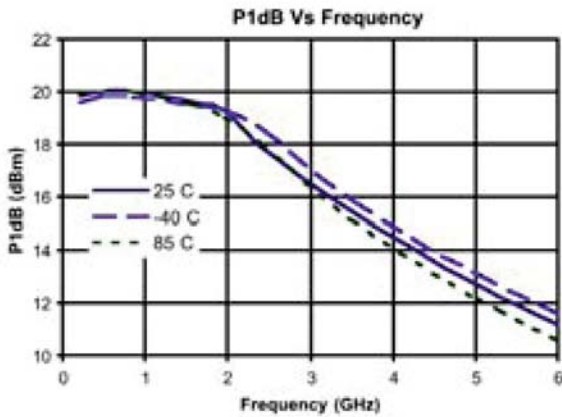

Linearity Performance - Base Station ACP - IS-95

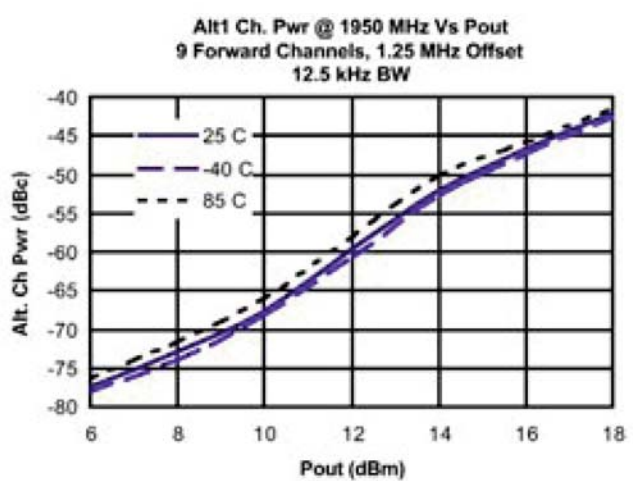
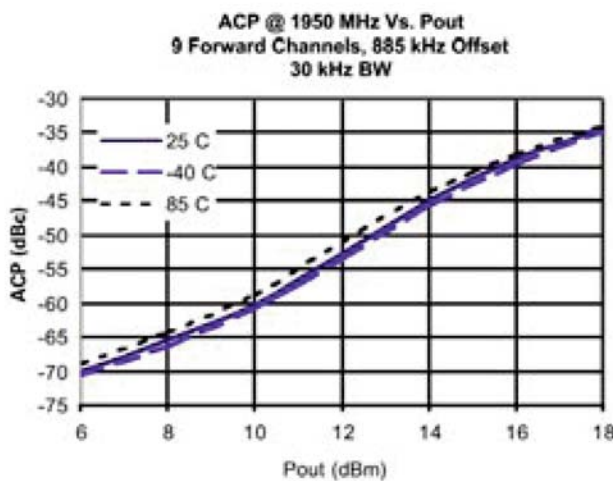
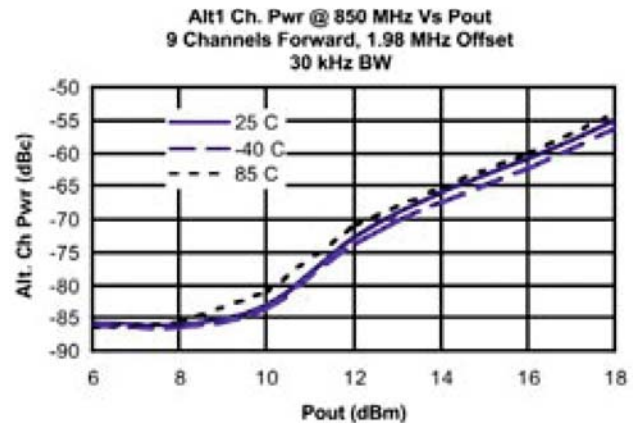
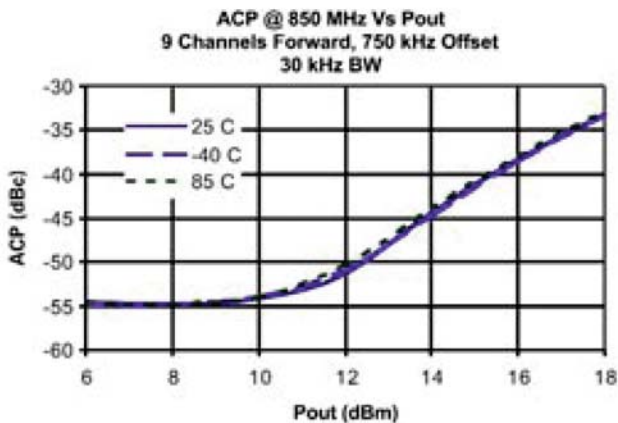

DC-6.0 GHz InGaP HBT, MMIC or Packaged, Matched Gain Block Amplifier



September 2006 - Rev 17-Sep-06

CGB7010-SC (-BD)
RoHS

Typical Scattering Parameters (Vd = +5.18V, Icc = 75 mA, T = 23°C, device in a 50 ohm system)

Frequency (MHz)	S ₁₁		S ₂₁		S ₁₂		S ₂₂	
	(Mag)	(Ang)	(Mag)	(Ang)	(Mag)	(Ang)	(Mag)	(Ang)
100	0.049	-171.30	13.44	173.10	0.060	-0.30	0.015	-79.86
200	0.053	-160.00	13.32	166.40	0.061	-0.89	0.028	-91.31
300	0.060	-153.50	13.20	159.80	0.061	-1.54	0.042	-100.20
400	0.067	-149.50	13.05	153.20	0.062	-2.03	0.054	-106.50
500	0.075	-145.80	12.86	146.80	0.062	-2.59	0.066	-111.50
600	0.084	-144.50	12.66	140.50	0.063	-3.32	0.077	-117.50
700	0.093	-144.50	12.45	134.20	0.064	-4.03	0.088	-123.00
800	0.101	-144.70	12.21	128.10	0.065	-4.72	0.098	-127.50
900	0.109	-145.50	11.97	122.00	0.066	-5.65	0.107	-132.50
1000	0.117	-146.80	11.74	116.00	0.067	-6.60	0.116	-137.40
1100	0.125	-148.30	11.48	110.20	0.068	-7.57	0.124	-141.90
1200	0.131	-149.80	11.22	104.40	0.069	-8.64	0.130	-146.30
1300	0.137	-151.50	10.96	98.71	0.070	-9.78	0.136	-150.60
1400	0.143	-153.20	10.70	93.14	0.072	-11.06	0.141	-154.60
1500	0.149	-155.10	10.44	87.66	0.073	-12.38	0.145	-158.60
1600	0.154	-156.90	10.19	82.29	0.075	-13.77	0.149	-162.50
1700	0.158	-158.70	9.94	76.99	0.076	-15.20	0.152	-166.30
1800	0.163	-160.70	9.70	71.77	0.078	-16.65	0.155	-170.00
1900	0.167	-162.60	9.46	66.64	0.079	-18.34	0.158	-173.50
2000	0.171	-164.70	9.23	61.59	0.081	-20.04	0.159	-177.10
2100	0.175	-166.60	9.01	56.58	0.083	-21.65	0.161	-179.40
2200	0.178	-168.60	8.79	51.66	0.084	-23.48	0.162	-176.10
2300	0.180	-170.70	8.59	46.79	0.086	-25.29	0.162	-172.80
2400	0.183	-172.70	8.39	41.99	0.088	-27.21	0.163	-169.70
2500	0.186	-174.80	8.20	37.26	0.090	-29.03	0.163	-166.40
2600	0.187	-176.80	8.01	32.61	0.091	-31.09	0.163	-163.40
2700	0.189	-178.90	7.84	28.00	0.093	-33.00	0.163	-160.60
2800	0.192	-178.90	7.68	23.40	0.095	-35.15	0.164	-157.50
2900	0.195	-176.40	7.53	18.80	0.097	-37.26	0.165	-154.30
3000	0.196	-174.00	7.37	14.28	0.100	-39.42	0.165	-151.20
3100	0.198	-171.50	7.24	9.79	0.101	-41.65	0.166	-148.00
3200	0.200	-168.80	7.11	5.26	0.104	-43.92	0.168	-144.70
3300	0.202	-165.80	6.98	0.73	0.106	-46.30	0.170	-141.20
3400	0.204	-162.70	6.86	-3.78	0.108	-48.66	0.171	-137.30
3500	0.205	-159.40	6.74	-8.26	0.110	-51.11	0.173	-133.70
3600	0.207	-156.00	6.62	-12.75	0.112	-53.68	0.175	-129.90
3700	0.207	-152.20	6.52	-17.21	0.115	-56.17	0.177	-125.70
3800	0.208	-148.30	6.41	-21.70	0.117	-58.85	0.181	-121.30
3900	0.201	-141.70	6.39	-25.74	0.119	-61.49	0.184	-116.90
4000	0.209	-139.40	6.22	-30.67	0.121	-64.17	0.187	-112.30
4100	0.209	-134.60	6.13	-35.16	0.123	-66.87	0.191	-107.50
4200	0.201	-127.60	6.11	-39.17	0.126	-69.81	0.194	-102.50
4300	0.208	-124.00	5.95	-44.18	0.128	-72.53	0.201	-97.20
4400	0.202	-116.20	5.94	-48.18	0.130	-75.60	0.207	-91.94
4500	0.202	-110.10	5.86	-52.75	0.133	-78.55	0.213	-86.38
4600	0.208	-105.80	5.71	-57.86	0.135	-81.50	0.220	-80.76
4700	0.203	-97.23	5.70	-61.89	0.137	-84.53	0.228	-75.23
4800	0.210	-91.85	5.55	-67.13	0.140	-87.69	0.238	-69.32
4900	0.208	-82.25	5.55	-71.19	0.141	-91.02	0.248	-63.58
5000	0.213	-74.40	5.48	-75.94	0.144	-94.22	0.260	-57.34

Continues Next Page. S-Parameter Data Files are available online at: www.mimixbroadband.com

Mimix Broadband, Inc., 10795 Rockley Rd., Houston, Texas 77099
Tel: 281.988.4600 Fax: 281.988.4615 mimixbroadband.com

Page 4 of 8

Characteristic Data and Specifications are subject to change without notice. ©2006 Mimix Broadband, Inc.
Export of this item may require appropriate export licensing from the U.S. Government. In purchasing these parts, U.S. Domestic customers accept their obligation to be compliant with U.S. Export Laws.

DC-6.0 GHz InGaP HBT, MMIC or Packaged, Matched Gain Block Amplifier



September 2006 - Rev 17-Sep-06

CGB7010-SC (-BD)
RoHS

Typical Scattering Parameters (Vd = +5.18V, Icc = 75 mA, T = 23°C, device in a 50 ohm system)

Frequency (MHz)	S ₁₁		S ₂₁		S ₁₂		S ₂₂	
	(Mag)	(Ang)	(Mag)	(Ang)	(Mag)	(Ang)	(Mag)	(Ang)
5100	0.217	66.79	5.40	-80.68	0.145	-97.59	0.271	51.36
5200	0.223	58.93	5.33	-85.42	0.147	-101.00	0.282	45.56
5300	0.231	50.72	5.25	-90.28	0.149	-104.50	0.296	39.79
5400	0.242	42.19	5.17	-95.19	0.151	-108.00	0.312	33.60
5500	0.254	34.21	5.09	-100.10	0.152	-111.70	0.328	27.71
5600	0.267	26.31	5.00	-105.00	0.153	-115.30	0.342	21.85
5700	0.282	18.55	4.91	-110.00	0.154	-119.00	0.360	16.20
5800	0.297	10.99	4.82	-115.10	0.155	-122.80	0.378	10.39
5900	0.314	3.22	4.72	-120.10	0.156	-126.60	0.395	4.52
6000	0.334	-3.85	4.62	-125.10	0.156	-130.40	0.415	-1.09
6100	0.354	-10.69	4.52	-130.10	0.156	-134.20	0.434	-6.66
6200	0.373	-17.30	4.41	-135.20	0.155	-138.00	0.453	-12.15
6300	0.392	-23.96	4.30	-140.30	0.155	-141.90	0.471	-17.50
6400	0.413	-30.38	4.19	-145.30	0.154	-145.70	0.490	-22.94
6500	0.434	-36.49	4.07	-150.40	0.153	-149.50	0.509	-28.13
6600	0.454	-42.30	3.95	-155.30	0.151	-153.30	0.526	-33.25
6700	0.474	-47.78	3.82	-160.20	0.150	-157.00	0.543	-38.36
6800	0.492	-53.27	3.70	-165.20	0.148	-160.70	0.559	-43.18
6900	0.510	-58.74	3.58	-170.00	0.146	-164.50	0.574	-48.01
7000	0.529	-64.03	3.45	-174.80	0.144	-168.10	0.589	-52.72
7100	0.546	-68.91	3.32	-179.40	0.141	-171.60	0.602	-57.19
7200	0.562	-73.60	3.20	-176.00	0.138	-175.10	0.615	-61.75
7300	0.575	-78.33	3.08	-171.50	0.136	-178.50	0.626	-66.05
7400	0.588	-83.00	2.97	-167.10	0.133	-178.20	0.636	-70.21
7500	0.600	-87.47	2.85	-162.60	0.130	-174.80	0.647	-74.31
7600	0.613	-91.70	2.74	-158.40	0.128	-171.70	0.656	-78.26
7700	0.624	-95.70	2.63	-154.30	0.125	-168.70	0.665	-82.00
7800	0.632	-99.56	2.53	-150.20	0.122	-165.70	0.672	-85.69
7900	0.639	-103.50	2.43	-146.10	0.119	-162.70	0.678	-89.22
8000	0.646	-107.50	2.34	-142.00	0.116	-159.90	0.684	-92.68
8100	0.654	-111.10	2.24	-138.20	0.114	-157.00	0.690	-96.08
8200	0.660	-114.50	2.15	-134.40	0.111	-154.30	0.696	-99.37
8300	0.664	-117.90	2.07	-130.70	0.109	-151.60	0.701	-102.50
8400	0.668	-121.20	1.99	-127.10	0.106	-149.10	0.704	-105.50
8500	0.670	-124.60	1.92	-123.40	0.104	-146.40	0.709	-108.50
8600	0.673	-128.00	1.84	-119.70	0.102	-143.90	0.712	-111.50
8700	0.677	-131.20	1.78	-116.20	0.099	-141.50	0.715	-114.30
8800	0.679	-134.00	1.71	-112.90	0.097	-139.20	0.719	-117.10
8900	0.678	-136.90	1.65	-109.50	0.095	-137.00	0.721	-119.70
9000	0.677	-140.00	1.59	-106.10	0.093	-134.60	0.723	-122.20
9100	0.677	-143.10	1.54	-102.70	0.091	-132.30	0.725	-124.80
9200	0.677	-146.10	1.48	-99.33	0.089	-130.00	0.727	-127.30
9300	0.676	-148.70	1.43	-96.07	0.088	-127.90	0.730	-129.70
9400	0.673	-151.40	1.39	-92.83	0.086	-125.80	0.732	-132.10
9500	0.670	-154.10	1.34	-89.61	0.084	-123.70	0.732	-134.30
9600	0.664	-157.10	1.30	-86.30	0.083	-121.60	0.733	-136.60
9700	0.661	-159.90	1.26	-82.96	0.081	-119.30	0.734	-138.80
9800	0.659	-162.50	1.22	-79.90	0.080	-117.30	0.735	-141.00
9900	0.654	-165.00	1.18	-76.79	0.078	-115.30	0.736	-143.10
10000	0.647	-167.50	1.15	-73.63	0.077	-113.60	0.738	-145.20

S-Parameter Data Files are available on-line at: www.mimixbroadband.com

Mimix Broadband, Inc., 10795 Rockley Rd., Houston, Texas 77099
Tel: 281.988.4600 Fax: 281.988.4615 mimixbroadband.com

Page 5 of 8

Characteristic Data and Specifications are subject to change without notice. ©2006 Mimix Broadband, Inc.
Export of this item may require appropriate export licensing from the U.S. Government. In purchasing these parts, U.S. Domestic customers accept their obligation to be compliant with U.S. Export Laws.

DC-6.0 GHz InGaP HBT, MMIC or Packaged, Matched Gain Block Amplifier



September 2006 - Rev 17-Sep-06

CGB7010-SC (-BD)
RoHS

Application Circuit

Note: This schematic represents the topology of the application circuit recommended by Mimix.

Recommended Bias Resistor Values for $I_D = 75 \text{ mA}$				
Supply Voltage (V)	7V	8V	10V	12V
Rbias (R1 Description: 1206 1/4W 1%)	25Ω	39Ω	—	—
Rbias (R1 Description: 1210 1/2W 1%)	—	—	65Ω	92Ω

Note: Rbias provides DC bias stability over temperature.

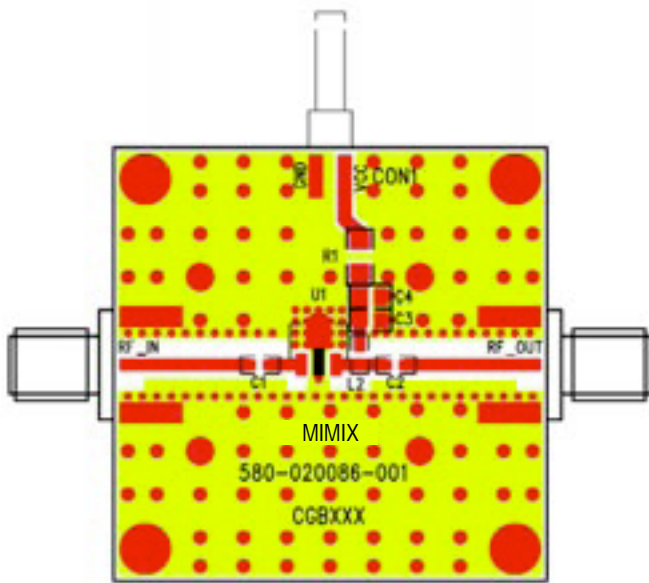
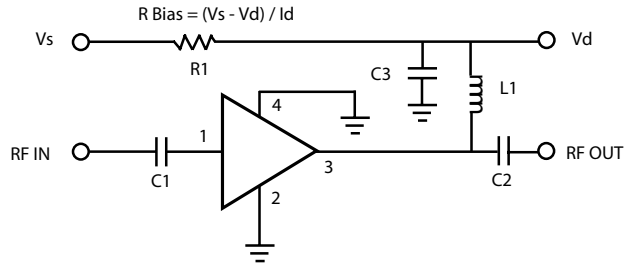

Ref Designator	Value	Description	Size
C1, C2	1000 pF	MCH185A101JK	0805
C3	1.0 μF	VITR 1.0 μF 25V CER CAP 0805 X7R 10%	0805
L1	56 nH	Coilcraft 0603 CS 10%	0603
R1		RBias = (Vs - Vd) / Id	1206 / 1210
C4		DNP (Do Not Place)	N/A

DC-6.0 GHz InGaP HBT, MMIC or Packaged, Matched Gain Block Amplifier



September 2006 - Rev 17-Sep-06

CGB7010-SC (-BD)
RoHS

Physical Dimensions - SC Package (SOT-89)

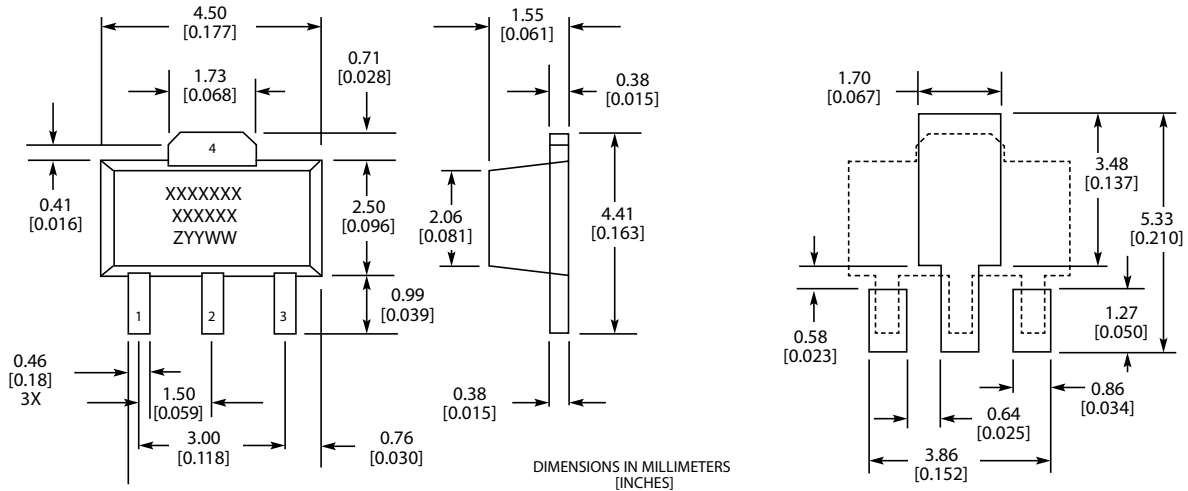

MARKINGS:
 XXXXXXX = MIMIX MODEL NO.
 XXXXXX = WAFER LOT NO.
 ZYYWW = DATE CODE (YR/WEEK)
 FIRST LETTER COUNTRY OF ORIGIN IF OTHER THAN USA

Physical Dimensions - BD (Bare Die)

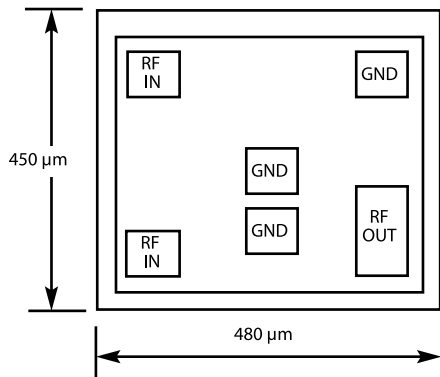

Notes:
 RF OUT bonding pad is 75 μm x 155 μm .
 All other pads are 75 μm x 75 μm .



DC-6.0 GHz InGaP HBT, MMIC or Packaged, Matched Gain Block Amplifier



September 2006 - Rev 17-Sep-06

CGB7010-SC (-BD)
RoHS

Handling and Assembly Information

CAUTION! - Mimix Broadband MMIC Products contain gallium arsenide (GaAs) which can be hazardous to the human body and the environment. For safety, observe the following procedures:

- Do not ingest.
- Do not alter the form of this product into a gas, powder, or liquid through burning, crushing, or chemical processing as these by-products are dangerous to the human body if inhaled, ingested, or swallowed.
- Observe government laws and company regulations when discarding this product. This product must be discarded in accordance with methods specified by applicable hazardous waste procedures.

Life Support Policy - Mimix Broadband's products are not authorized for use as critical components in life support devices or systems without the express written approval of the President and General Counsel of Mimix Broadband. As used herein: (1) Life support devices or systems are devices or systems which, (a) are intended for surgical implant into the body, or (b) support or sustain life, and whose failure to perform when properly used in accordance with instructions for use provided in the labeling, can be reasonably expected to result in a significant injury to the user. (2) A critical component is any component of a life support device or system whose failure to perform can be reasonably expected to cause the failure of the life support device or system, or to affect its safety or effectiveness.

Package Attachment - This packaged product from Mimix Broadband is provided as a rugged surface mount package compatible with high volume solder installation. Care should be taken not to apply heavy pressure to the top or base material to avoid package damage. Vacuum tools or other suitable pick and place equipment may be used to pick and place this part. Care should be taken to ensure that there are no voids or gaps in the solder connection so that good RF, DC and ground connections are maintained. Voids or gaps can eventually lead not only to RF performance degradation, but reduced reliability and life of the product due to thermal stress.

Mimix Lead-Free RoHS Compliant Program - Mimix has an active program in place to meet customer and governmental requirements for eliminating lead (Pb) and other environmentally hazardous materials from our products. All Mimix RoHS compliant components are form, fit and functional replacements for their non-RoHS equivalents. Lead plating of our RoHS compliant parts is 100% matt tin (Sn) over copper alloy and is backwards compatible with current standard SnPb low-temperature reflow processes as well as higher temperature (260°C reflow) "Pb Free" processes.

Ordering Information

Part Number for Ordering	Description
CGB7010-BD	Bare die in GelPak
CGB7010-SC-0G00	Matte Tin plated RoHS compliant SOT-89 surface mount package in bulk quantity
CGB7010-SC-0G0T	Matte Tin plated RoHS compliant SOT-89 surface mount package in tape and reel
CGB7010-SP-0G00	Matte Tin plated RoHS compliant SOT-86 surface mount package in bulk quantity
CGB7010-SP-0G0T	Matte Tin plated RoHS compliant SOT-86 surface mount package in tape and reel
PB-CGB7010-SC-0000	Evaluation Board for SOT-89 packaged device with SMA connectors
PB-CGB7010-SP-0000	Evaluation Board for SOT-86 packaged device with SMA connectors

We also offer the plastic packages with SnPb (Tin-Lead) or NiPdAu plating. Please contact your regional sales manager for more information regarding different plating types