

# 12-17GHz Integrated Down Converter

## GaAs Monolithic Microwave IC

*preliminary*

### Description

The CHR2291 is a multifunction chip which integrates a LO time two multiplier, a balanced cold FET mixer, and a RF LNA. It is designed for a wide range of applications, typically commercial communication systems. The backside of the chip is both RF and DC grounds. This helps simplify the assembly process.

The circuit is manufactured with a PM-HEMT process, 0.25 $\mu$ m gate length, via holes through the substrate, air bridges and electron beam gate lithography. It is available in chip form.

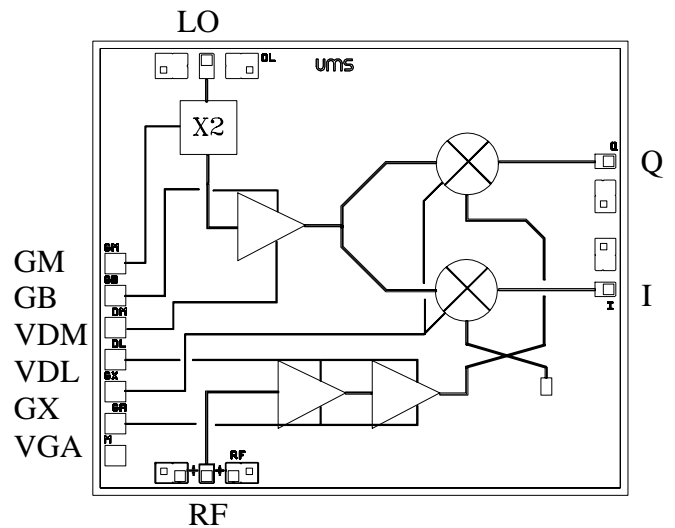

### Main Features

- Broadband performances : 12-17GHz
- 10 dB conversion gain
- 3.5dB noise figure
- 10dBm LO input power
- -8dBm RF input power (1dB gain comp.)
- Low DC power consumption, 130mA@3.5V
- Chip size : 2.49 X 2.13 X 0.10 mm

Typical on wafer measurement:  
Conversion Gain & Image suppression @ IF=1& 1.5GHz

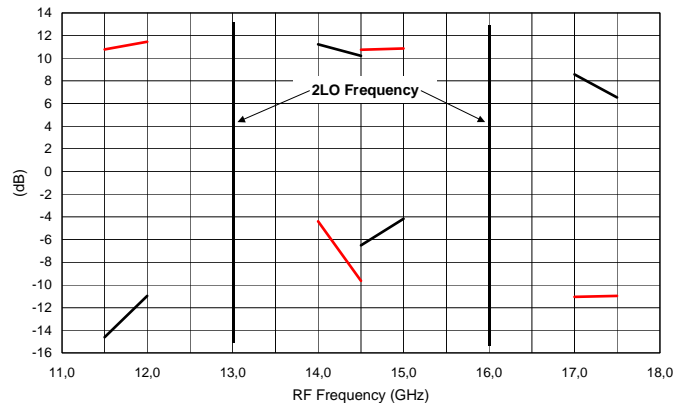

### Main Characteristics

Tamb. = 25°C

	Parameter	Min	Typ	Max	Unit
F <sub>RF</sub>	RF frequency range	12		17	GHz
F <sub>LO</sub>	LO frequency range	5.25		7.75	GHz
F <sub>IF</sub>	IF frequency range	0.25		1.5	GHz
G <sub>c</sub>	Conversion gain		+10		dB

ESD Protection : Electrostatic discharge sensitive device. Observe handling precautions !

## Electrical Characteristics for Broadband Operation

Tamb = +25°C, Vd = 3.5V, Idl=50mA, Idm=50mA

*preliminary*

Symbol	Parameter	Min	Typ	Max	Unit
F <sub>RF</sub>	RF frequency range	12		17	GHz
F <sub>LO</sub>	LO frequency range	5.25		7.75	GHz
F <sub>IF</sub>	IF frequency range	0.25		1.5	GHz
G <sub>c</sub>	Conversion gain (1)		+10		dB
NF	Noise Figure (1)		3.5		dB
P <sub>LO</sub>	LO Input power		+10		dBm
Img Sup	Image Suppression		15		dBc
P1dB	Input power at 1dB gain compression		-8		dBm
LO VSWR	Input LO VSWR (1)		2.0:1		
RF VSWR	Input RF VSWR (1)		2.0:1		
Id	Bias current (2)		100		mA

(1) On Wafer measurements

(2) Current source biasing network is recommended. Optimum performances for Idm= 50mA and Idl= 50mA

## Absolute Maximum Ratings

Tamb. = 25°C (1)

Symbol	Parameter	Values	Unit
Vd	Maximum drain bias voltage	4.0	V
Id	Maximum drain bias current	180	mA
Vg	Gate bias voltage	-2.0 to +0.4	V
Vdg	Maximum drain to gate voltage ( Vd- Vg)	+5	V
Pin	Maximum peak input power overdrive (2)	+15	dBm
Tch	Maximum channel temperature	175	°C
Ta	Operating temperature range	-40 to +85	°C
Tstg	Storage temperature range	-55 to +125	°C

(1) Operation of this device above anyone of these parameters may cause permanent damage.

(2) Duration < 1s.

*preliminary*

## Typical On-wafer Measurements

Bias Conditions :  $V_{dm} = V_{dl} = 3.5\text{ V}$ ,  $V_{gm} = -0.7\text{ V}$ ,  $V_{gb} = -0.4\text{ V}$ ,  $V_{gx} = -0.6\text{ V}$ ,  $V_{ga} = -0.4\text{ V}$

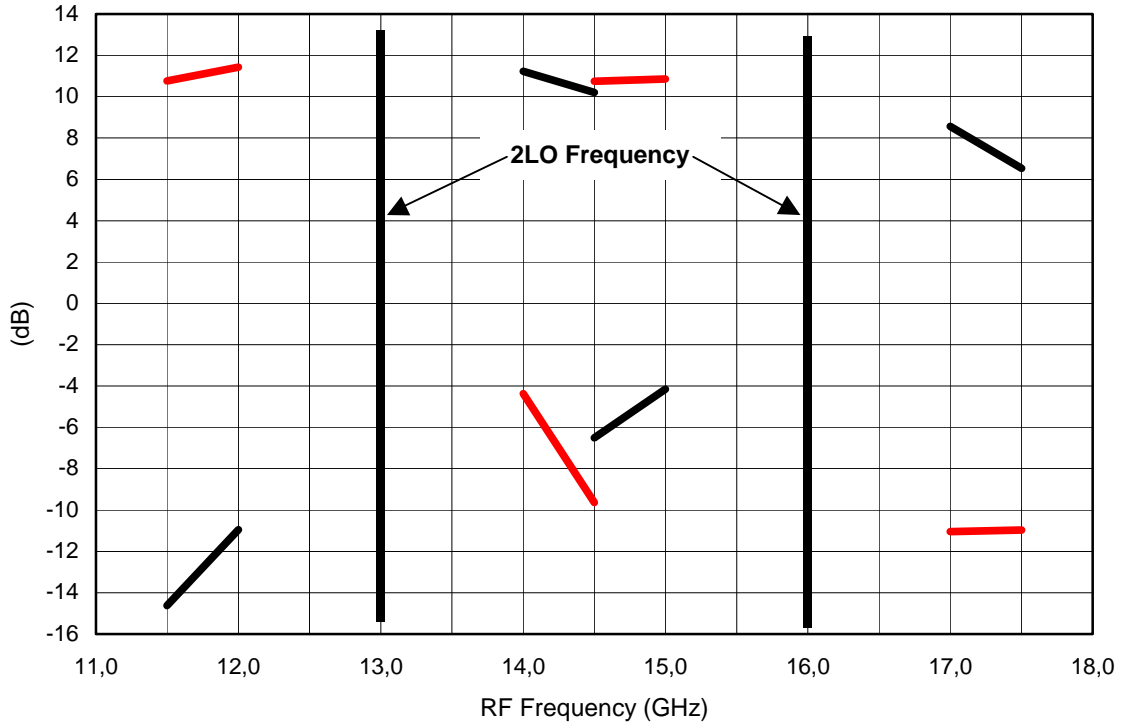

Conversion gain & Image suppression with a 90° IQ combiner @ IF=1 & 1.5GHz

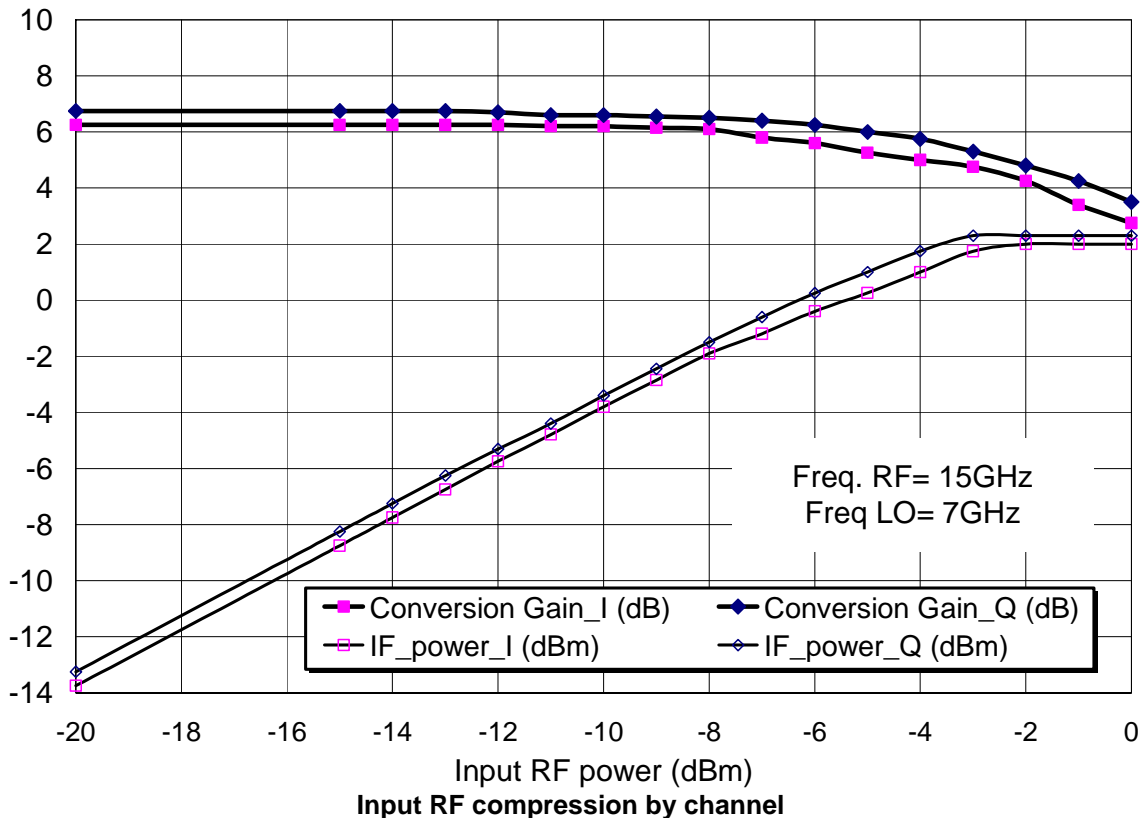

Input RF compression by channel

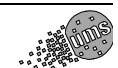

## Typical On-board Measurements

Bias Conditions :  $V_{dm} = V_{dl} = 3.5\text{ V}$ ,  $V_{gm} = -0.7\text{ V}$ ,  $V_{gb} = -0.4\text{ V}$ ,  $V_{gx} = -0.6\text{ V}$ ,  $V_{ga} = -0.4\text{ V}$

*preliminary*

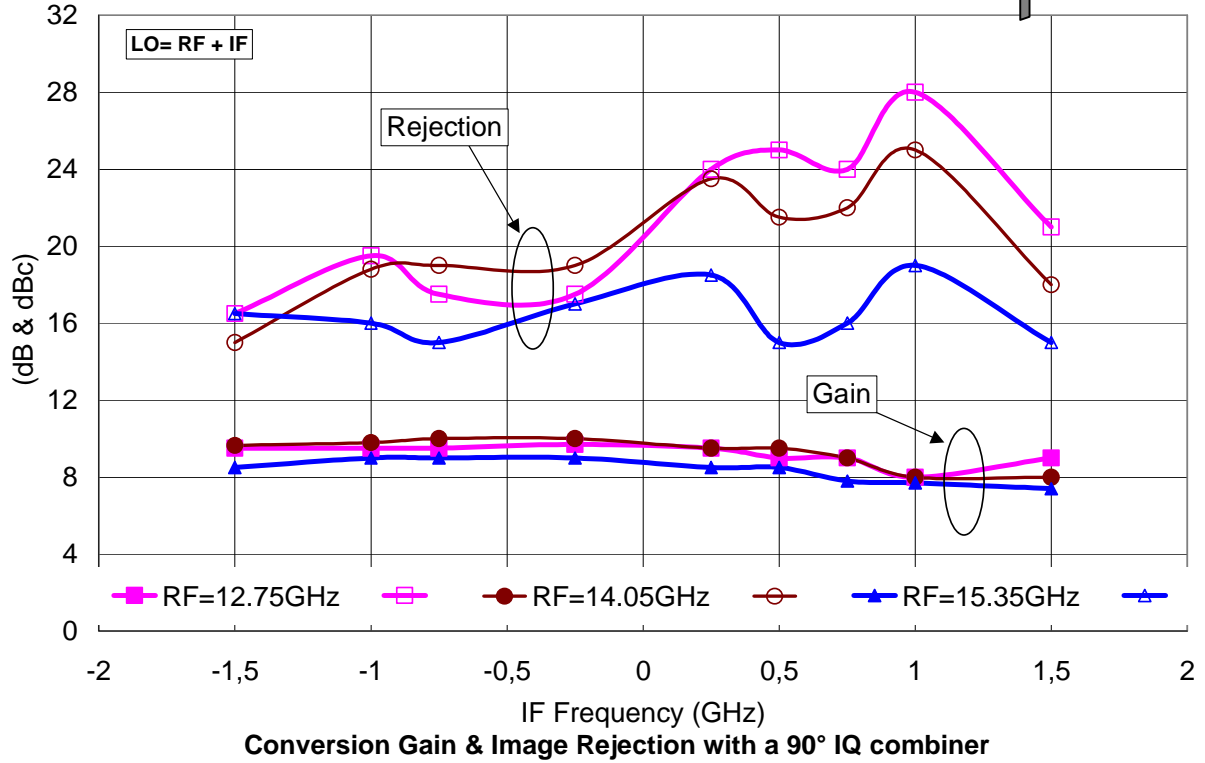

*preliminary*

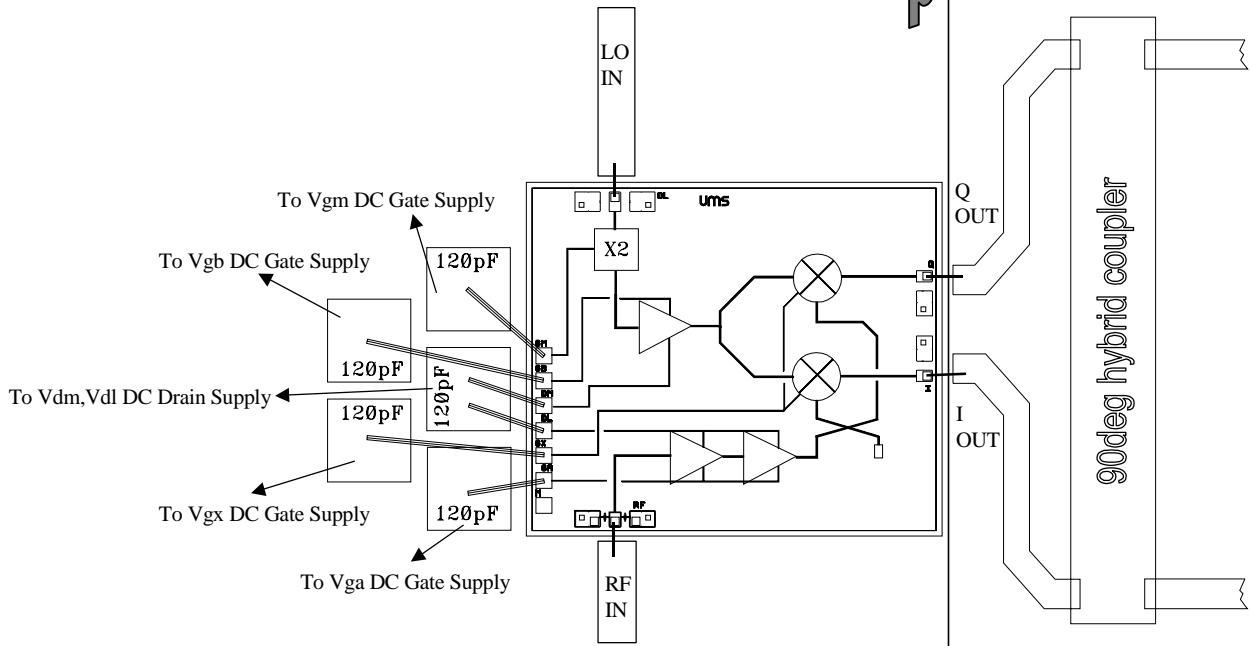

Note : Supply feed should be capacitively bypassed. 25µm diameter gold wire is recommended

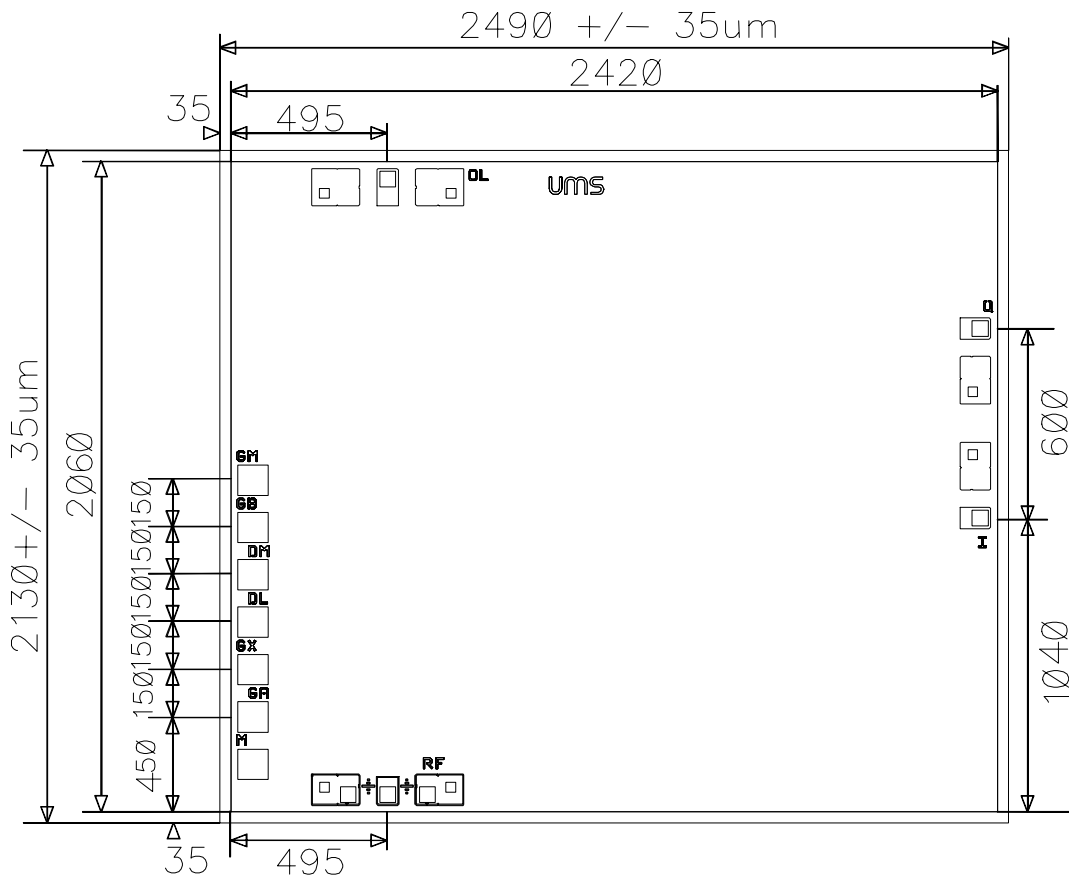

### Bonding pad positions

( Chip thickness : 100µm. All dimensions are in micrometers )

*preliminary*

## Ordering Information

Chip form : CHR2291-99F/00

Information furnished is believed to be accurate and reliable. However **United Monolithic Semiconductors S.A.S.** assumes no responsibility for the consequences of use of such information nor for any infringement of patents or other rights of third parties which may result from its use. No license is granted by implication or otherwise under any patent or patent rights of **United Monolithic Semiconductors S.A.S.** Specifications mentioned in this publication are subject to change without notice. This publication supersedes and replaces all information previously supplied. **United Monolithic Semiconductors S.A.S.** products are not authorised for use as critical components in life support devices or systems without express written approval from **United Monolithic Semiconductors S.A.S.**