



### CHTA30/CHTB35

High Temperature 150°C Series  
400/600/800V - TRIAC

#### Applications

- Heat Regulation
  - Ovens
  - Coffee Makers
  - Cookers
- Light Dimming
- Control of Inductive Loads
  - Motors
  - Transformers

- > Superior Commutating Performance at High Temperature  
(di/dt)<sub>c</sub> = 25A/ms @ (dv/dt)<sub>c</sub> = 50V/μs
- > Ideal for Most Demanding Applications
- > Alternistor/No Snubber Type
- > IGT 50 mA
- > VDRM/VRMM 400, 600, 800V

#### Absolute Maximum Ratings

	CONDITIONS	SYMBOL	RATING
RMS On-State Current (full sine wave)	T <sub>c</sub> = 120°C T <sub>c</sub> = 95°C	T <sub>O</sub> -220AB T <sub>O</sub> -220AB Iso	I <sub>T(RMS)</sub> 35A (CHTB) 30A (CHTA)
Non Repetitive Surge Peak On-State Current (Full Cycle, T <sub>j</sub> Initial = 25°C)	F = 50 Hz F = 60 Hz	I <sub>TSM</sub>	380A 400A
I <sup>2</sup> t Value for fusing	t <sub>p</sub> = 10 ms	I <sup>2</sup> t	660A <sup>2</sup> s
Critical rate of rise of on-state current I <sub>G</sub> = 2 x I <sub>GT</sub> , t <sub>r</sub> < 100 ns, T <sub>j</sub> = 150°C		di/dt	100A/μsec
Peak Gate Current @ T <sub>j</sub> = 150°C	t <sub>p</sub> = 20 μs	I <sub>GM</sub>	4A
Average Gate Power Dissipation @ T <sub>j</sub> = 150°C		PG(AV)	1W
Storage Temperature Range		T <sub>stg</sub>	-40 to +150°C
Operating Junction Temperature Range		T <sub>j</sub>	-40 to +150°C
Isolation Voltage (CHTA Series only)		V <sub>ISO</sub>	2500 V <sub>RMS</sub>

#### Electrical Characteristics

I <sub>GT</sub> MAX @ V <sub>D</sub> = 12 V, R <sub>L</sub> = 30Ω <sup>NOTE 1</sup>	QI-II-III	50mA	
V <sub>GT</sub> MAX @ V <sub>D</sub> = 12 V, R <sub>L</sub> = 30Ω	QI-II-III	1.3V	
V <sub>GD</sub> MIN @ V <sub>D</sub> = V <sub>DRM</sub> , R <sub>L</sub> = 3.3kΩ	T <sub>j</sub> = 150°C	QI-II-III	0.15V
I <sub>H</sub> MAX @ I <sub>T</sub> = 500 mA <sup>NOTE 2</sup>			75mA
I <sub>L</sub> MAX @ I <sub>G</sub> = 1.2 I <sub>GT</sub>	QI-III		75mA
I <sub>L</sub> MAX @ I <sub>G</sub> = 1.2 I <sub>GT</sub>	Q-II		100mA
dv/dt MIN @ V <sub>D</sub> = 67%V <sub>DRM</sub> (gate open) <sup>NOTE 2</sup>	T <sub>j</sub> = 150°C		500V/μsec
(di/dt) <sub>c</sub> MIN without snubber <sup>NOTES 2 &amp; 4</sup>	T <sub>j</sub> = 150°C		25A/msec

#### Static Characteristics

V <sub>T</sub> MAX @ I <sub>TM</sub> = 48 A, t <sub>p</sub> = 380μs <sup>NOTE 2</sup>	T <sub>j</sub> = 25°C		1.5V
V <sub>to</sub> MAX @ Threshold Voltage <sup>NOTE 2</sup>	T <sub>j</sub> = 150°C		0.8V
R <sub>d</sub> MAX @ Dynamic Resistance <sup>NOTE 2</sup>	T <sub>j</sub> = 150°C		19m Ω
I <sub>DRM</sub> MAX @ V <sub>DRM</sub> = V <sub>RDM</sub>	T <sub>j</sub> = 25°C		5μA
I <sub>RRM</sub> MAX @ V <sub>DRM</sub> = V <sub>RDM</sub>	T <sub>j</sub> = 150°C		8.5mA

#### GENERAL NOTES

1. Minimum IGT is guaranteed at 5% of IGT max.
2. For both polarities of A2 referenced to A1
3. All parameters at 25 degrees C unless otherwise specified.
4. Commutating dv/dt = 50V/μs, {exponential to 200Vpk}

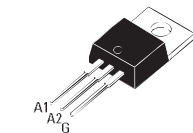

TO-220AB Isolated  
(CHTA30)

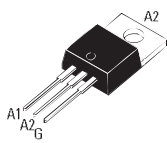

TO-220AB Non-Isolated  
(CHTB35)



ISO9001 Certified



# CHTA30/CHTB35

## High Temperature 150°C Series

400/600/800V - TRIAC

### Thermal Resistances

	SYMBOL	RATING
Junction to Case (AC)	TO-220AB	Rth(j-c) 0.8 °C/W
Junction to Case (AC)	TO-220AB Isolated	Rth(j-c) 1.7 °C/W
Junction to Ambient	TO-220AB	Rth(j-a) 60 °C/W
Junction to Ambient	TO-220AB Isolated	Rth(j-a) 60 °C/W

### Part Number Selection

Part Number	Voltage [Vpk]	Ic [mA]	Type	Package
CHTA30-xxxB	400, 600, 800	50mA	Standard	TO-220AB
CHTB35-xxxB	400, 600, 800	50mA	Standard	TO-220AB

### Part Number Designation

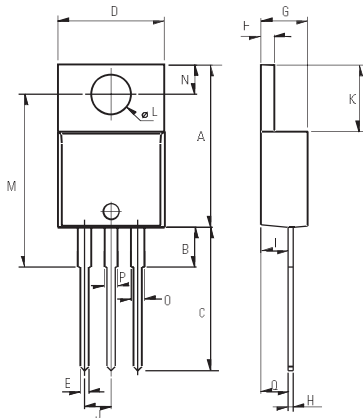
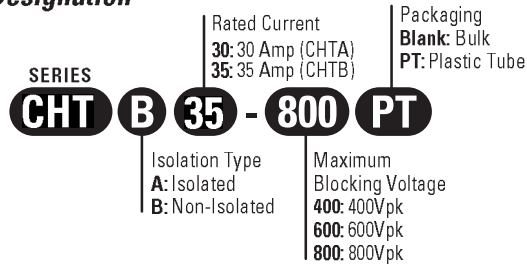

Weight: 2.3g (0.08 oz)

### Dimensions

REF.	Millimeters			Inches		
	Min.	Typ.	Max.	Min.	Typ.	Max.
A	15.24		15.75	0.6		0.62
B		3.23			0.127	
C	12.78		13.79	0.503		0.543
D	9.96		10.36	0.392		0.408
E	0.69		0.94	0.027		0.037
F	1.22		1.32	0.048		0.052
G	4.62		4.83	0.182		0.19
H	0.46		0.61	0.018		0.024
I	2.49		2.84	0.098		0.112
J	2.39		2.69	0.094		0.106
K	6.48		6.88	0.255		0.271
L	3.78		3.89	0.149		0.153
M	15.49	16	16.51	0.61	0.63	0.65
N	2.59		2.9	0.102		0.114
O	0.99		1.55	0.039		0.061
P	0.99		1.55	0.039		0.061
Q		2.67			0.105	

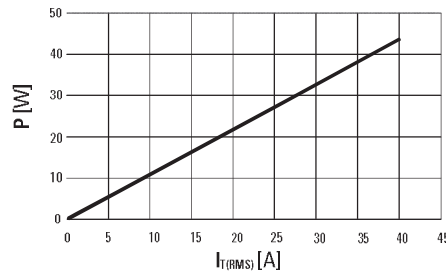

Fig. 1: Power dissipation versus RMS on-state current (full cycle).

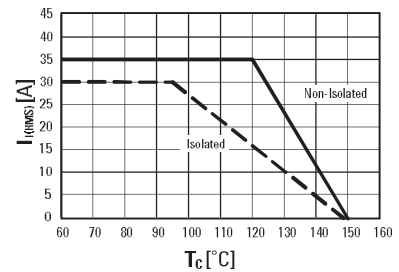

Fig. 2: RMS on-state current versus case temperature (full cycle)

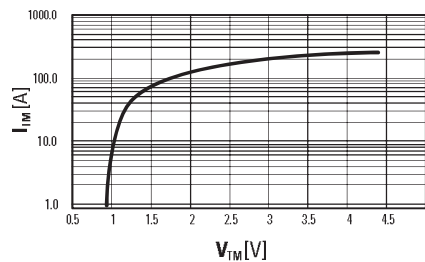

Fig. 3: On-state current versus on-state voltage (instantaneous values)

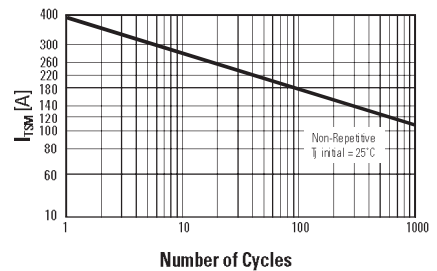

Fig. 4: Non-repetitive surge peak on-state current versus number of cycles.

ISO9001 Certified

### Approvals

#6 Approved Component - E72445

**USA**  
 Sales Support (877) 502-5500  
 Tech Support (877) 702-7700  
 Fax (619) 710-8540  
 Email: sales@crydom.com  
 Crydom Corp  
 2320 Paseo de las Americas, Suite 201  
 San Diego, CA 92154

**EUROPE - UK**  
 Telephone +44 (0) 1202 365070  
 Fax +44 (0) 1202 365090  
 Email: intsales@crydom.com  
 Crydom International Ltd.  
 7 Cobham Road  
 Ferndown Industrial Estate  
 Wimborne, Dorset BH21 7PE

**ASIA - Thailand**  
 Telephone +66 (0)2 665 2517  
 Fax +66 (0)2 665 2588  
 Crydom Asia  
 18/8 Fico Place 12th Floor  
 Soi Sukhumvit 21 (Asoke)  
 Klongtoey Nua, Wattana  
 Bangkok, Thailand 10110

**Germany**  
 Telephone +49 (0) 180 3000 506