

## 1.5 Amp Dual Mode Low Dropout CMOS Regulator

### Features

- Adjustable Output or Internally Fixed
- 375mV dropout at 1.5A load current
- Operates from 2.2V to 5.5V input supply
- Low Ground current (330 $\mu$ A at 1.5A Load)
- Minimal output capacitance required
- Current Limit Protection
- Thermal Overload Protection
- Reverse Voltage Protection
- Thermally enhanced 8-pin SOIC package
- Lead-free versions available

### Applications

- Low Voltage "Core" processors
- Graphics Cards
- Gigabit NIC Cards
- PC Motherboards
- Notebooks

### Product Description

The CM3003 is a family of very low dropout regulators that offers dual mode operation. When the Adjust control pin (ADJ) is grounded, these devices automatically enter a fixed voltage mode and deliver either a 1.8V or 2.5V output capable of supplying 1.5A, depending on the device utilized. When the Adjust pin is connected to an external resistor network the device automatically operates as an adjustable regulator. The Adjust pin can also be tied directly to the OUT pin which configures the CM3003 as a 1.2V regulator.

An Enable control pin (EN) allows the device to be placed in a low current mode.

The CM3003 devices are fully protected, offering both overload current limiting, short circuit protection and high temperature thermal shutdown. These devices also includes reverse voltage protection that minimizes any reverse current flow back into the output pin.

The CM3003 devices are housed in a space saving, 8-pin power SOIC packages which has been thermally enhanced (integral leadframe) to ensure maximum junction to ambient power dissipation.

The CM3003 devices are available with optional lead-free finishing.

### Typical Application Circuit

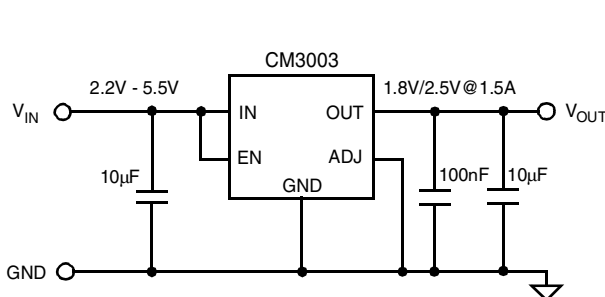

### Simplified Electrical Schematic

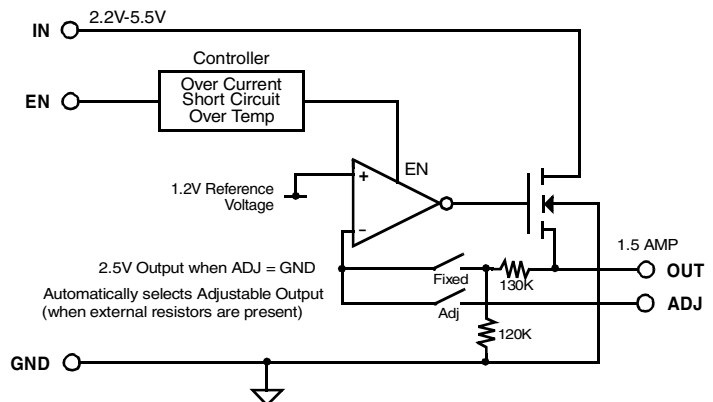



**PACKAGE / PINOUT DIAGRAM**

TOP VIEW

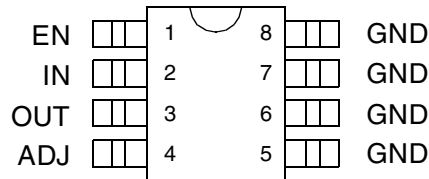

8-pin Power SOIC

Note: This drawing is not to scale.

**PIN DESCRIPTIONS**

PIN(S)	NAME	DESCRIPTION
1	EN	Enable/shutdown input. When EN is asserted high ( $V_{EN} \geq 1.2V$ ), the regulator is enabled. When EN is asserted low ( $V_{EN} \leq 0.4V$ ), the regulator is shut down.
2	IN	Positive input voltage for the regulator. If this input pin is greater than 2 inches from the main input filter, a $10\mu F$ ceramic capacitor is recommended for adequate filtering.
3	OUT	The regulated voltage output. An output capacitor of $10\mu F$ is recommended to minimize any transient load disturbances under normal operating conditions. Additional output capacitance can be used to further improve transient load response.
4	ADJ	Feedback input. When ADJ is grounded, the device enters fixed voltage mode. When ADJ is connected to an external resistor network, the device operates as an adjustable regulator. The Adjust pin can also be tied directly to the OUT pin which configures the CM3003 as a 1.2V regulator.
5-8	GND	The negative reference for all voltages. Also functions as a thermal path for heat dissipation.

**Ordering Information**

**PART NUMBERING INFORMATION**

Pins	Output Voltage	Package	Standard Finish		Lead-free Finish	
			Ordering Part Number <sup>1</sup>	Part Marking	Ordering Part Number <sup>1</sup>	Part Marking
8	2.5	SOIC-8	CM3003-25SA	CM3003-25SA	CM3003-25SF	CM3003-25SF
8	1.8	SOIC-8	CM3003-18SA	CM3003-18SA	CM3003-18SF	CM3003-18SF

Note 1: Parts are shipped in Tape & Reel form unless otherwise specified.



## Specifications

ABSOLUTE MAXIMUM RATINGS		
PARAMETER	RATING	UNITS
ESD Protection (HBM)	±2000	V
Pin Voltages IN, OUT, ADJ, EN	[GND - 0.4] to +6.0	V
Storage Temperature Range	-40 to +150	°C
Operating Temperature Range Ambient Junction	-40 to +85 -40 to +150	°C °C
Power Dissipation (See note 1)	Internally Limited	W

Note 1: The SOIC package used is thermally enhanced through the use of a fused integral leadframe. The power rating is based on a printed circuit board heat spreading capability equivalent to 2 square inches of copper connected to the GND pins. Typical multi-layer boards using power plane construction will provide this heat spreading ability without the need for additional dedicated copper area. (Please consult with factory for thermal evaluation assistance)

STANDARD OPERATING CONDITIONS		
PARAMETER	VALUE	UNITS
V <sub>IN</sub>	2.2 to 5.5	V
Ambient Operating Temperature Range	0 to +85	°C
Load Current	0 to 1500	mA
C <sub>EXT</sub>	10 ±20%	µF

**ELECTRICAL OPERATING CHARACTERISTICS** (SEE NOTE 1)

SYMBOL	PARAMETER	CONDITIONS	MIN	TYP	MAX	UNITS
V <sub>OUT</sub>	Regulator Output Voltage CM3003-25 CM3003-18	0mA < I <sub>LOAD</sub> < 1.5A, V <sub>IN</sub> =3.3V, V <sub>ADJ</sub> =0V	2.40 1.73	2.50 1.80	2.60 1.87	V
V <sub>REF</sub>	Internal Reference Voltage		1.15	1.20	1.25	V
I <sub>LIM</sub>	Overload Current Limit	V <sub>OUT</sub> > 1.2V	2.2	3.0	3.8	A
I <sub>SC</sub>	Short Circuit Current Limit	V <sub>OUT</sub> < 0.2V	0.5	1.2	1.8	A
V <sub>R LOAD</sub>	Load Regulation	V <sub>IN</sub> =3.3V, 100mA ≤ I <sub>LOAD</sub> ≤ 1.5A		5		mV
V <sub>R LINE</sub>	Line Regulation	I <sub>LOAD</sub> = 5mA; 3.0V ≤ V <sub>IN</sub> ≤ to 5.0V		20		mV
V <sub>DROPOUT</sub>	Dropout Voltage	I <sub>LOAD</sub> = 100mA		25	45	mV
		I <sub>LOAD</sub> = 1.0A		250	450	mV
		I <sub>LOAD</sub> = 1.5A		330	670	mV
I <sub>GND</sub>	Ground Current	Regulator Disabled (EN=GND); V <sub>IN</sub> =3.3V		5	30	μA
		Regulator Enabled (EN=V <sub>IN</sub> =3.3V); I <sub>LOAD</sub> = 0mA		325	500	μA
		Regulator Enabled (EN=V <sub>IN</sub> =3.3V); I <sub>LOAD</sub> = 1.5A		330	550	μA
I <sub>ROUT</sub>	Output Reverse Leakage	V <sub>OUT</sub> =3.3V; V <sub>IN</sub> = 0V		30	100	μA
T <sub>DISABLE</sub>	Shutdown Temperature			160		°C
T <sub>HYST</sub>	Thermal Hysteresis			25		°C

**Enable Pin Input**

V <sub>EN_TH</sub>	EN Input Threshold Voltage	Regulator Enabled	0.4	0.8	1.2	V
I <sub>EN</sub>	Enable Input Leakage Current	0V < V <sub>EN</sub> < 5.5V		0.1	5	μA

**Adjust Pin Input (output set by external resistors)**

V <sub>ADJ_TH</sub>	ADJ Input Threshold Voltage		0.1	0.2	0.3	V
I <sub>EN</sub>	ADJ Input Leakage Current	V <sub>ADJ</sub> > 1.1V		0.1	1	μA

Note 1: Operating Characteristics are over Standard Operating Conditions unless otherwise specified.

**Application Information**

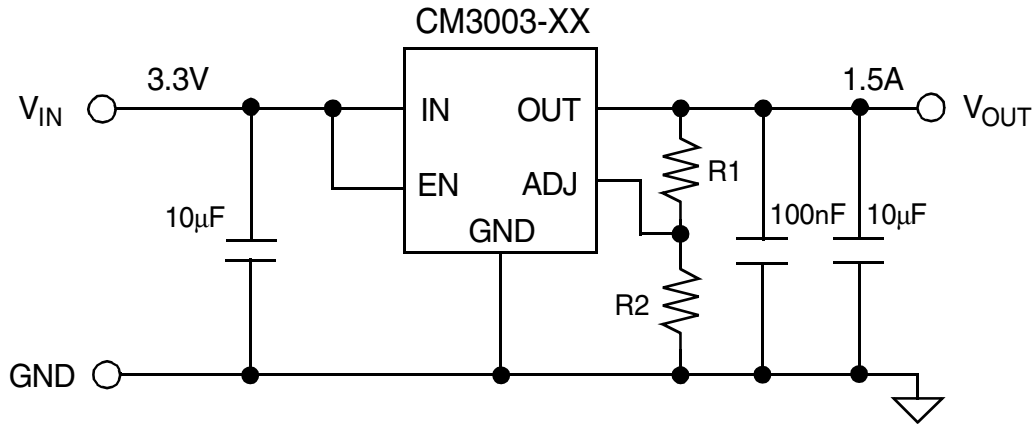

**Figure 1. Application Circuit for Adjustable Output Operation.**

$$\text{Output Voltage} = 1.20 (R1+R2) / R2 \text{ [VOLTS]}$$



### Performance Information

CM3003 Typical DC Characteristics ( $T_A=25^\circ\text{C}$ ,  $EN=V_{IN}=3.3\text{V}$ ,  $C_{IN}=C_{OUT}=10\mu\text{F}$ , unless specified otherwise)

CM3003-25 Device Specific Data

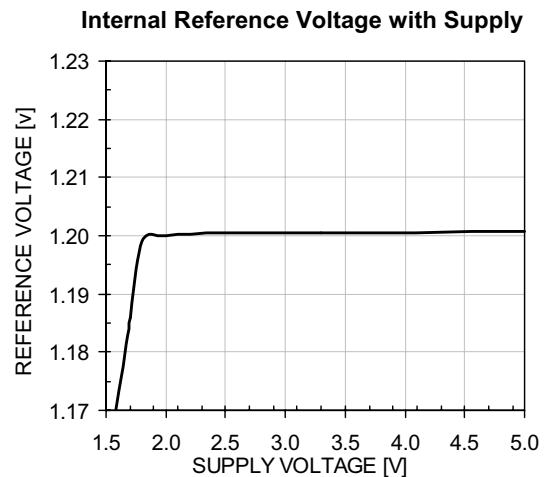
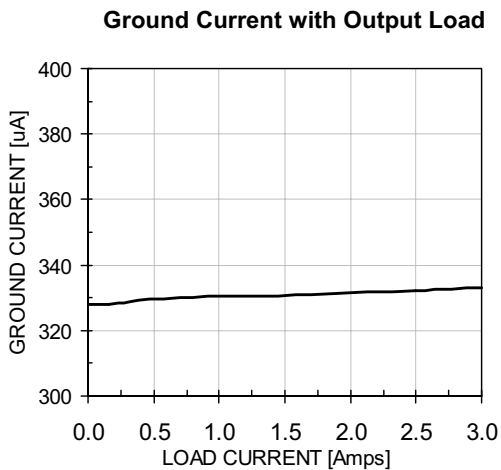
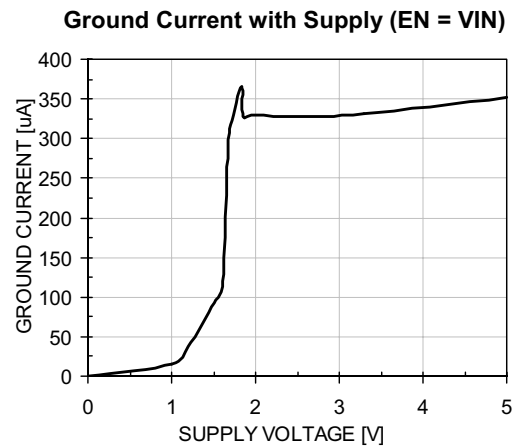
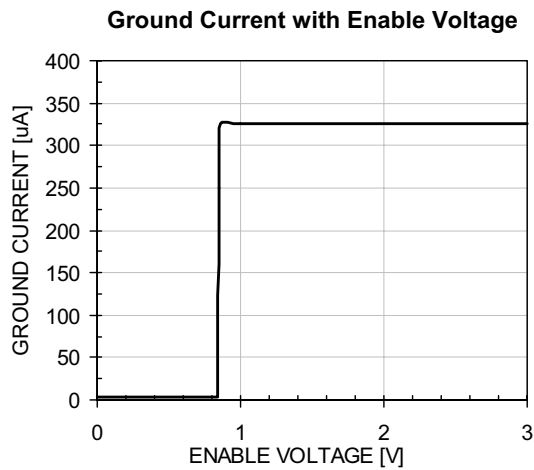
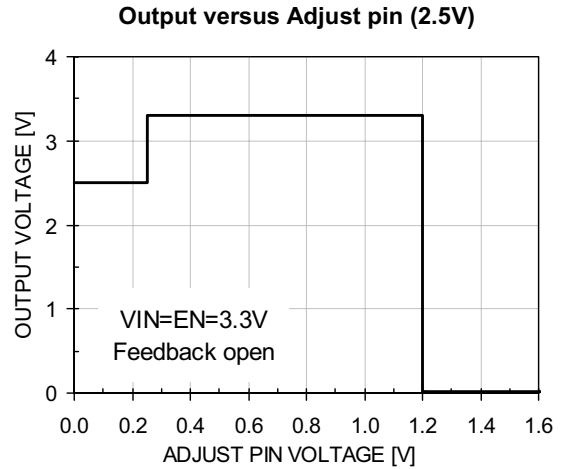
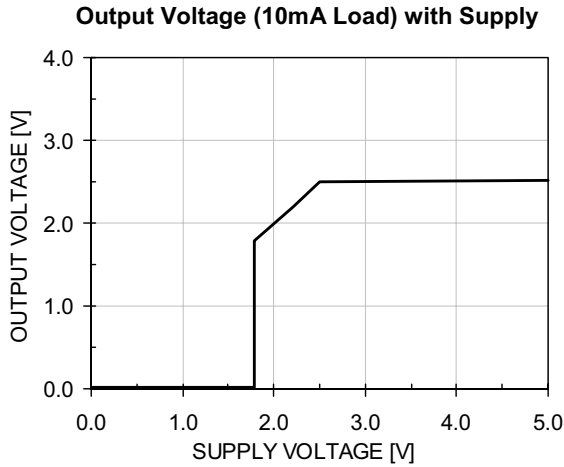



### Performance Information (cont'd)

CM3003 Typical DC Characteristics ( $T_A=25^\circ\text{C}$ ,  $E_N=V_{IN}=3.3\text{V}$ ,  $C_{IN}=C_{OUT}=10\mu\text{F}$ , unless specified otherwise)

CM3003-25 Device Specific Data

Line Regulation (2.5V, 10mA Load)

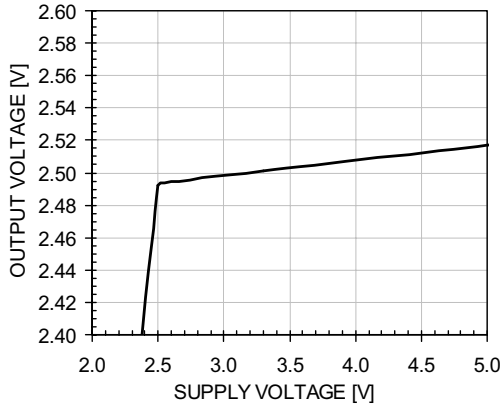

Load Regulation

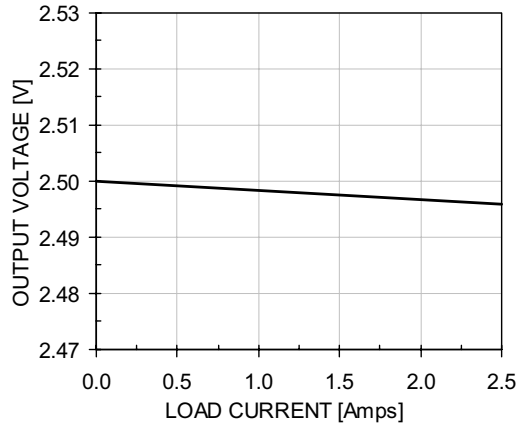

Dropout Voltage (0.5A) with Supply

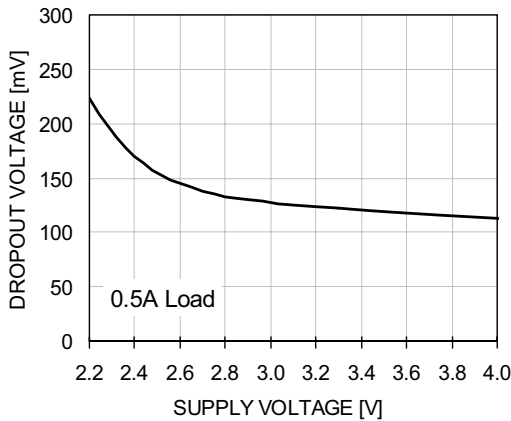

Dropout Voltage with Load

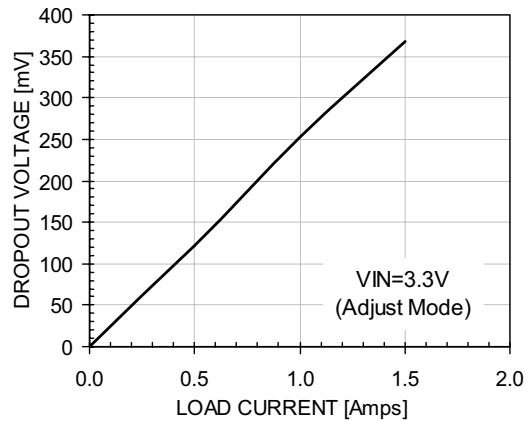

Current limit protection

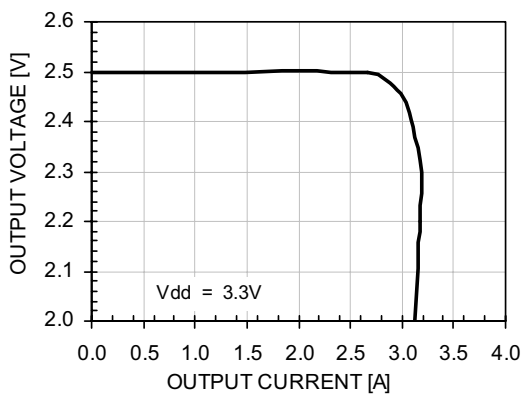

Current limit with input voltage

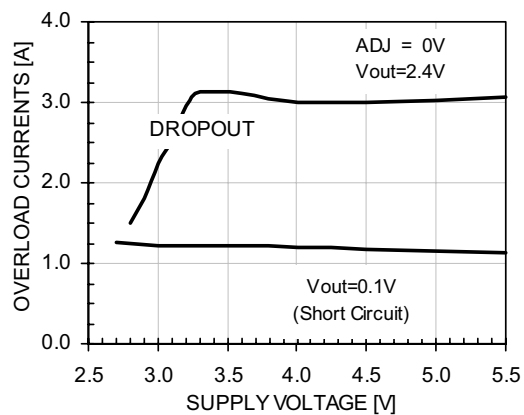

**Performance Information (cont'd)**

CM3003 Transient Characteristics ( $T_A=25^{\circ}\text{C}$ ,  $\text{EN}=\text{V}_{\text{IN}}=3.3\text{V}$ ,  $\text{C}_{\text{IN}}=\text{C}_{\text{OUT}}=10\mu\text{F}$ , unless specified otherwise)

CM3003-25 Device Specific Data

**Cold Start Power-Up/Down with 10mA Load**

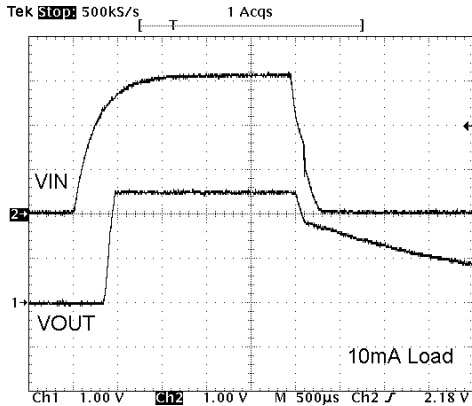

**Cold Start Power-Up/Down with 1.5A Load**

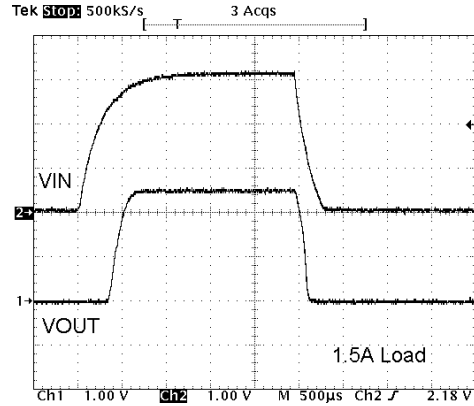

**Enable Power-Up with 10mA Load**

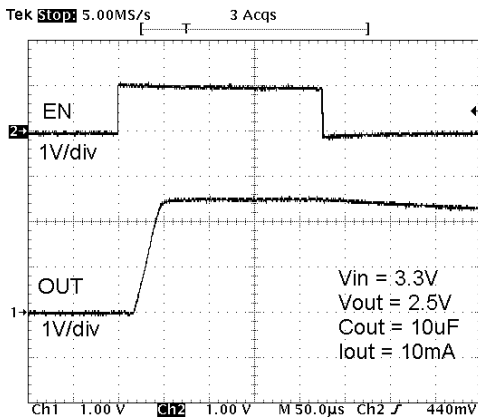

**Enable Power-Up with 1.5A Load**

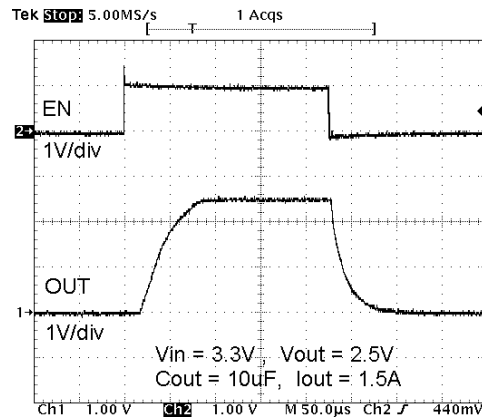

**Power Supply Rejection with 25mA Load**

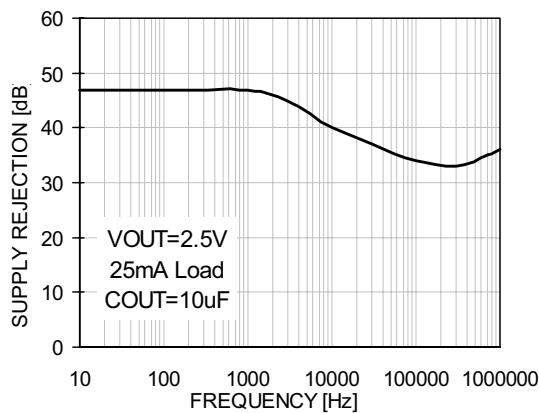

**Power Supply Rejection with 1.5A Load**

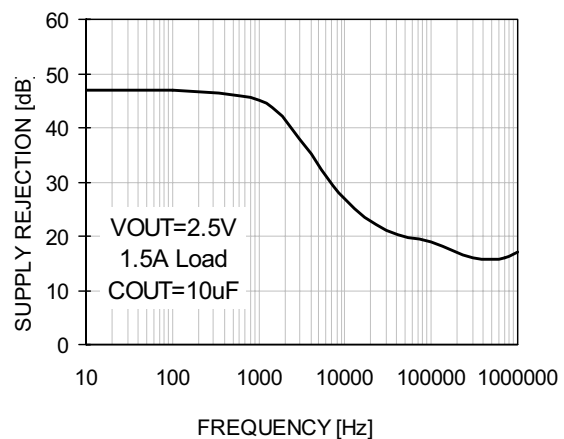





### Performance Information (cont'd)

CM3003 Transient Characteristics ( $T_A=25^{\circ}\text{C}$ ,  $EN=V_{IN}=3.3\text{V}$ ,  $C_{IN}=C_{OUT}=10\mu\text{F}$ , unless specified otherwise)

CM3003-25 Device Specific Data

#### Line Transient Response with 25mA Load

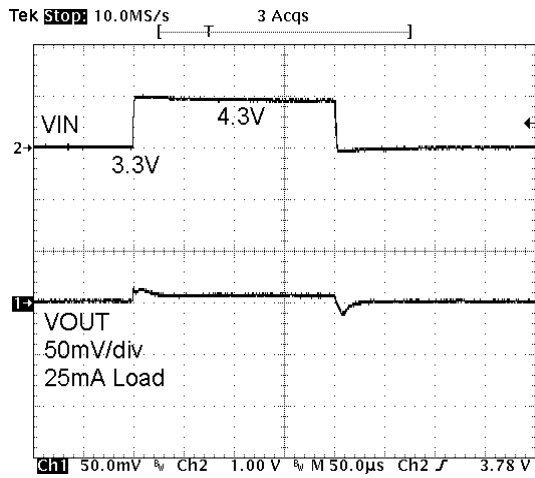

#### Line Transient Response with 1.5A Load

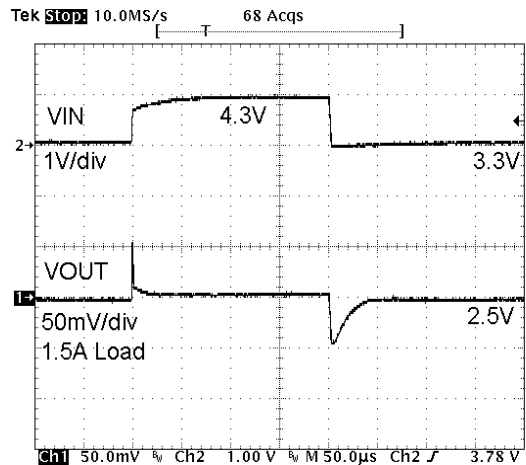

#### Load Transient Response (25mA to 1A)

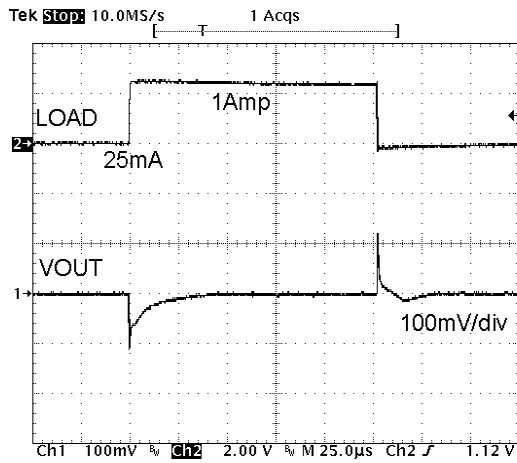

#### Load Transient Response (100mA to 1.5A)

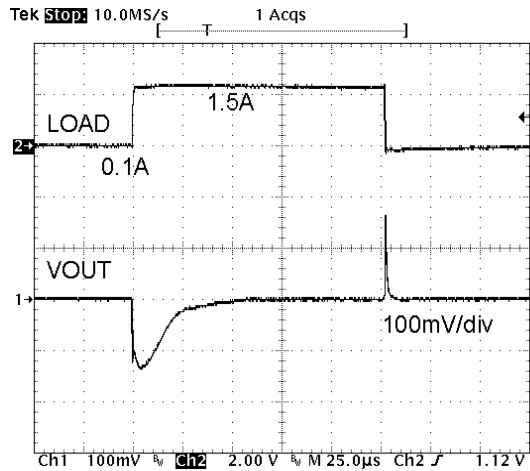



## Performance Information (cont'd)

### CM3003 Typical Thermal Characteristics

The overall junction to ambient thermal resistance ( $\theta_{JA}$ ) for device power dissipation (PD) consists primarily of two paths in series. The first path is the junction to the case ( $\theta_{JC}$ ) which is defined by the package style, and the second path is case to ambient ( $\theta_{CA}$ ) thermal resistance which is dependent on board layout. The final operating junction temperature for any set of conditions can be estimated by the following thermal equation:

$$\begin{aligned} T_{JUNC} &= T_{AMB} + P_D (\theta_{JC}) + P_D (\theta_{CA}) \\ &= T_{AMB} + P_D (\theta_{JA}) \end{aligned}$$

The CM3003 uses a thermally enhanced package where all the GND pins (5 through 8) are integral to the leadframe. When this package is mounted on a double sided printed circuit board with two square inches of copper allocated for "heat spreading", the resulting  $\theta_{JA}$  is about 50°C/W.

Based on a typical operating power dissipation of 1.0W (3.0V-2.5Vx 2.0A) with an ambient of 70°C, the resulting junction temperature will be:

$$\begin{aligned} T_{JUNC} &= T_{AMB} + P_D (\theta_{JA}) \\ &= 70^\circ\text{C} + 1.0\text{W} \times (50^\circ\text{C}/\text{W}) \\ &= 70^\circ\text{C} + 50^\circ\text{C} = 120^\circ\text{C} \end{aligned}$$

Thermal characteristics were measured using a double sided board with two square inches of copper area connected to the GND pin for "heat spreading".

Measurements showing performance up to junction temperature of 125°C were performed under light load conditions (5mA). This allows the ambient temperature to be representative of the internal junction temperature.

Note: The use of multi-layer board construction with separate ground and power planes will further enhance the overall thermal performance. In the event of no copper area being dedicated for heat spreading, a multi-layer board construction, using only the minimum size pad layout, will provide the CM3003 with an overall  $\theta_{JA}$  of 70°C/W which allows up to 800mW to be safely dissipated for the maximum junction temperature.

Internal Reference Voltage over Temperature

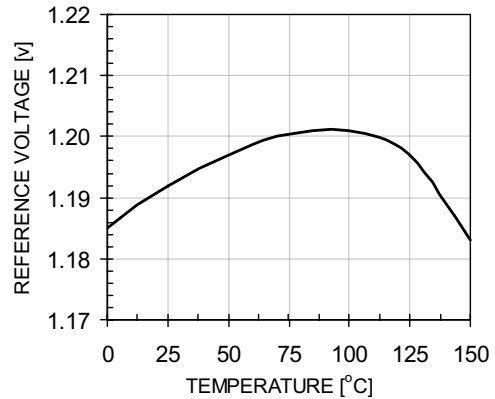

Output Voltage (2.5V) over Temperature

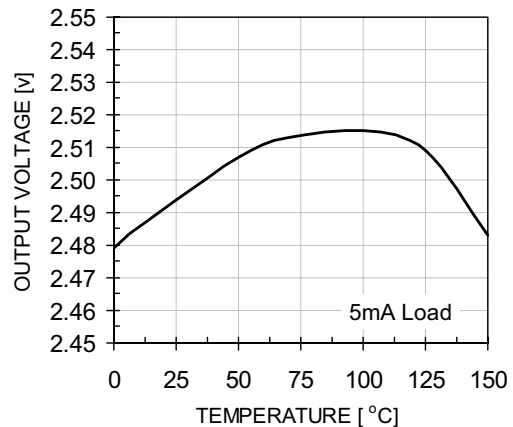

Ground Current over Temperature

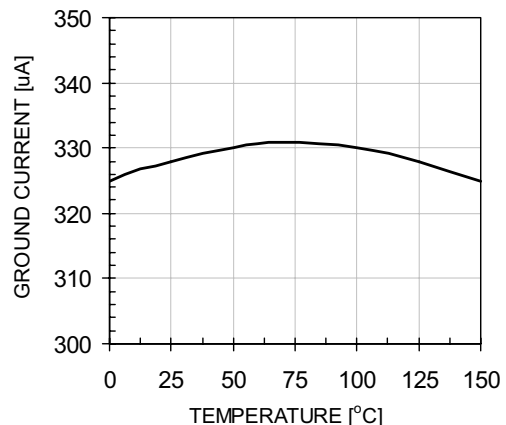



## Mechanical Details

### SOIC-8 Mechanical Specifications

Dimensions for CM3003 devices packaged in 8-pin SOIC packages are presented below.

For complete information on the SOIC-8 package, see the California Micro Devices SOIC Package Information document.

PACKAGE DIMENSIONS				
Package	SOIC			
Pins	8			
Dimensions	Millimeters		Inches	
	Min	Max	Min	Max
A	1.35	1.75	0.053	0.069
A <sub>1</sub>	0.10	0.25	0.004	0.010
B	0.33	0.51	0.013	0.020
C	0.19	0.25	0.007	0.010
D	4.80	5.00	0.189	0.197
E	3.80	4.19	0.150	0.165
e	1.27 BSC		0.050 BSC	
H	5.80	6.20	0.228	0.244
L	0.40	1.27	0.016	0.050
# per tube	100 pieces*			
# per tape and reel	2500 pieces			
Controlling dimension: inches				

\* This is an approximate number which may vary.

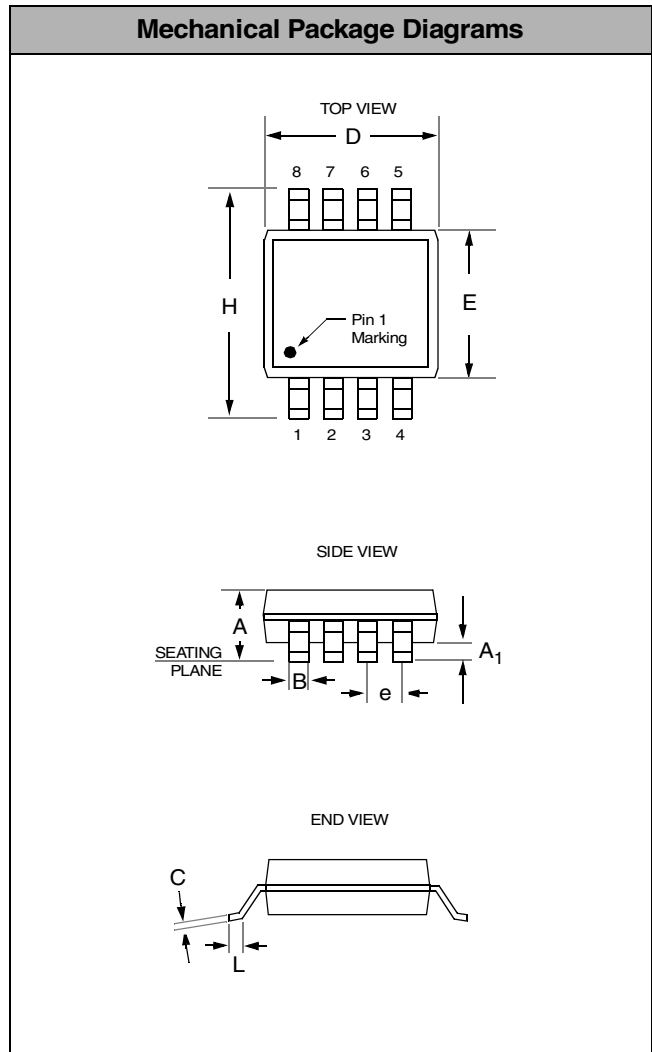

Package Dimensions for SOIC-8