

Trench Gate Design Single IGBTMOD™ 450 Amperes/250 Volts

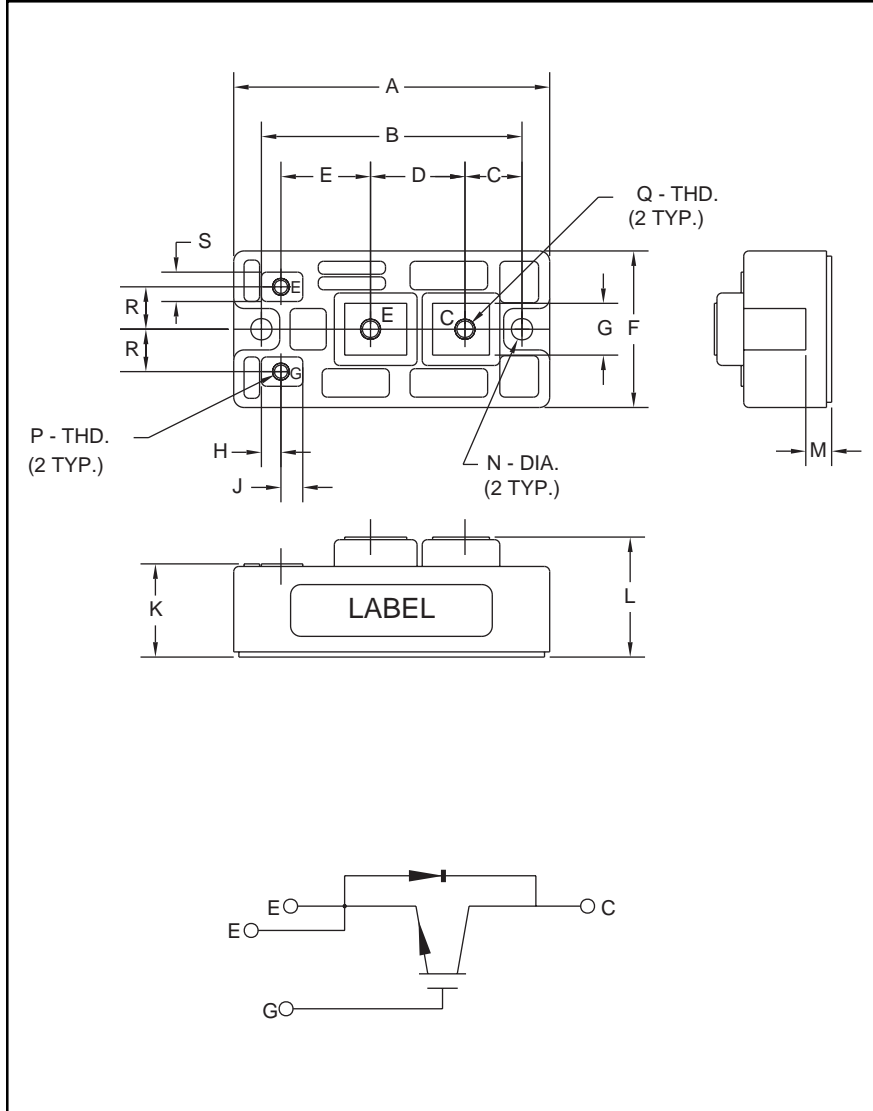

Outline Drawing and Circuit Diagram

Dimensions	Inches	Millimeters
A	3.82	97.0
B	3.15	80.0
C	0.69	17.5
D	1.14	29.0
E	1.04	26.5
F	1.89	48.0
G	0.63	16.0
H	0.24	6.0
J	0.26	6.7

Dimensions	Inches	Millimeters
K	1.14	29.0
L	1.42	36.0
M	0.28	7.0
N	0.26	6.5
P	M4 Metric	M4
Q	M5 Metric	M5
R	0.51	13.0
S	0.35	9.0



Description:

Powerex IGBTMOD™ Modules are designed for use in switching applications. Each module consists of one IGBT Transistor in a single configuration, with a reverse connected super-fast recovery free-wheel diode. All components and interconnects are isolated from the heat sinking baseplate, offering simplified system assembly and thermal management.

Features:

- Low Drive Power
- Low $V_{CE(sat)}$
- Discrete Super-Fast Recovery Free-Wheel Diodes
- High Frequency Operation (20-25 kHz)
- Isolated Baseplate for Easy Heat Sinking

Applications:

- DC Chopper
- UPS
- Forklift

Ordering Information:

Example: Select the complete nine digit module part number you desire from the table below - i.e. CM450HA-5F is a 250V (V_{CES}), 450 Ampere Single IGBTMOD™ Power Module.

Type	Current Rating Amperes	V_{CES} Volts (x 50)
CM	450	5

CM450HA-5F
Trench Gate Design Single IGBTMOD™
 450 Amperes/250 Volts

Absolute Maximum Ratings, $T_j = 25^\circ\text{C}$ unless otherwise specified

Characteristics	Symbol	CM450HA-5F	Units
Junction Temperature	T_j	-40 to 150	$^\circ\text{C}$
Storage Temperature	T_{stg}	-40 to 125	$^\circ\text{C}$
Collector-Emitter Voltage (G-E Short)	V_{CES}	250	Volts
Gate-Emitter Voltage (C-E Short)	V_{GES}	± 20	Volts
Collector Current	I_C	450	Amperes
Peak Collector Current	I_{CM}	900*	Amperes
Diode Forward Current	I_{FM}	450	Amperes
Diode Forward Surge Current	I_{FM}	900*	Amperes
Power Dissipation	P_d	735	Watts
Maximum Mounting Torque, M6 Terminal Screws	—	26	in-lb
Maximum Mounting Torque, M6 Mounting Screws	—	26	in-lb
Maximum Mounting Torque, M4 (G, E) Terminal Screws	—	13	in-lb
Module Weight (Typical)	—	270	Grams
V Isolation Voltage	V_{RMS}	2500	Volts

Static Electrical Characteristics, $T_j = 25^\circ\text{C}$ unless otherwise specified

Characteristics	Symbol	Test Conditions	Min.	Typ.	Max.	Units
Collector-Cutoff Current	I_{CES}	$V_{\text{CE}} = V_{\text{CES}}, V_{\text{GE}} = 0\text{V}$	—	—	1.0	mA
Gate Leakage Current	I_{GES}	$V_{\text{GE}} = V_{\text{GES}}, V_{\text{CE}} = 0\text{V}$	—	—	0.5	μA
Gate-Emitter Threshold Voltage	$V_{\text{GE(th)}}$	$I_C = 45\text{mA}, V_{\text{CE}} = 10\text{V}$	3.0	4.0	5.0	Volts
Collector-Emitter Saturation Voltage	$V_{\text{CE(sat)}}$	$I_C = 450\text{A}, V_{\text{GE}} = 10\text{V}$	—	1.2	1.7	Volts
		$I_C = 450\text{A}, V_{\text{GE}} = 10\text{V}, T_j = 150^\circ\text{C}$	—	1.1	—	Volts
Total Gate Charge	Q_G	$V_{\text{CC}} = 50\text{V}, I_C = 450\text{A}, V_{\text{GS}} = 15\text{V}$	—	1760	—	nC
Diode Forward Voltage	V_{FM}	$I_E = 450\text{A}, V_{\text{GS}} = 0\text{V}$	—	—	2.0	Volts

Dynamic Electrical Characteristics, $T_j = 25^\circ\text{C}$ unless otherwise specified

Characteristics	Symbol	Test Conditions	Min.	Typ.	Max.	Units	
Input Capacitance	C_{IES}		—	—	132	nF	
Output Capacitance	C_{OES}	$V_{\text{GE}} = 0\text{V}, V_{\text{CE}} = 10\text{V}$	—	—	6	nF	
Reverse Transfer Capacitance	C_{RES}		—	—	4.5	nF	
Resistive	Turn-on Delay Time	$t_{\text{d(on)}}$	—	—	1200	ns	
							Load
Switching	Turn-off Delay Time	$t_{\text{d(off)}}$	—	—	900	ns	
							Times
Diode Reverse Recovery Time	t_{rr}	$I_E = 450\text{A}, di_E/dt = -900\text{A/ms}$	—	—	300	ns	
Diode Reverse Recovery Charge	Q_{rr}	$I_E = 450\text{A}, di_E/dt = -900\text{A/ms}$	—	7.6	—	μC	

Thermal and Mechanical Electrical Characteristics, $T_j = 25^\circ\text{C}$ unless otherwise specified

Characteristics	Symbol	Test Conditions	Min.	Typ.	Max.	Units
Thermal Resistance, Junction to Case	$R_{\text{th(j-c)}}$	Per IGBT	—	—	0.17	$^\circ\text{C/W}$
Thermal Resistance, Junction to Case	$R_{\text{th(j-c)}}$	Per Free Wheel Diode	—	—	0.23	$^\circ\text{C/W}$
Contact Thermal Resistance	$R_{\text{th(c-f)}}$	Per Module, Thermal Grease Applied	—	—	0.090	$^\circ\text{C/W}$

CM450HA-5F
Trench Gate Design Single IGBTMOD™
 450 Amperes/250 Volts

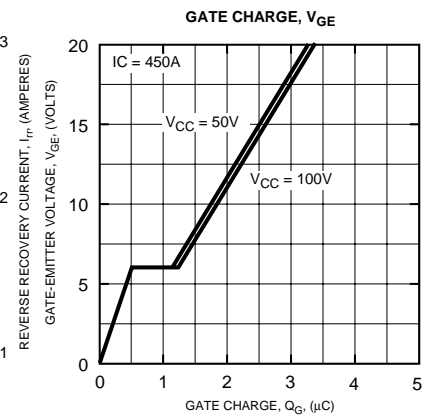
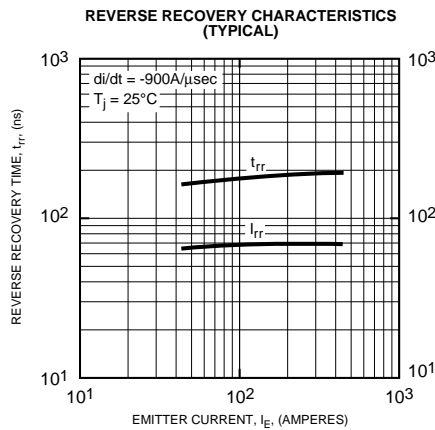
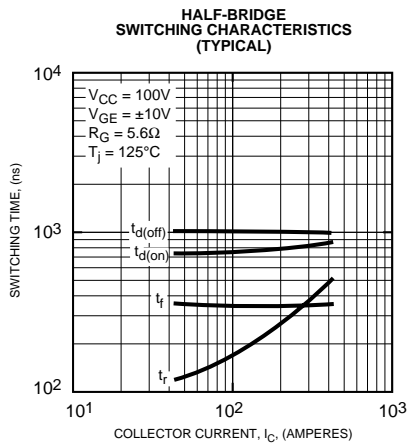
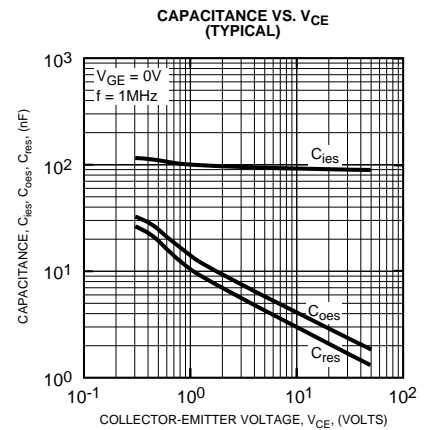
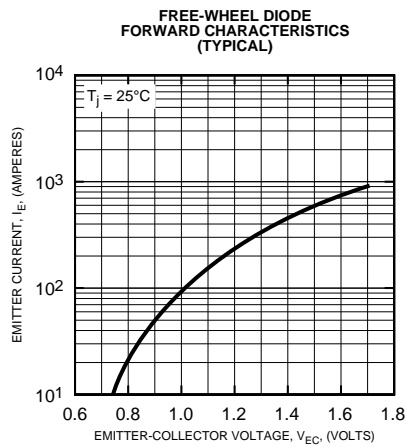
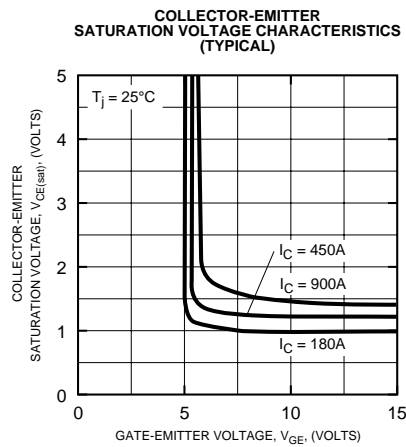
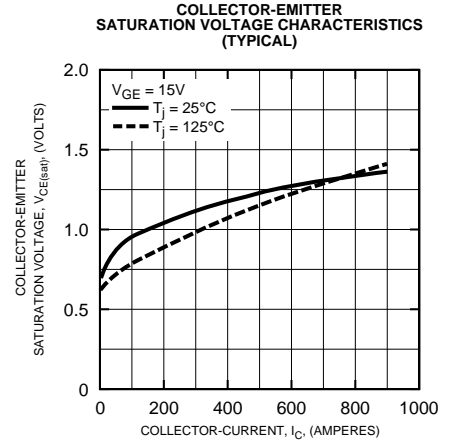
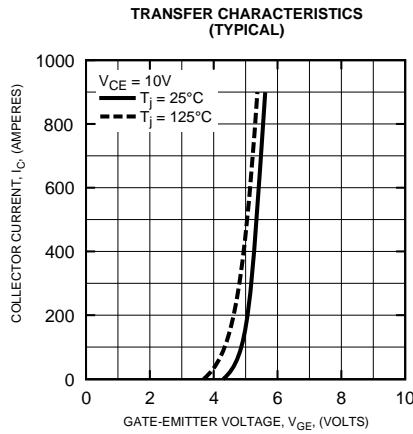
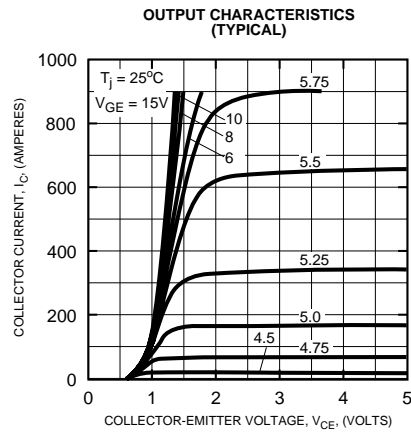

CM450HA-5F
Trench Gate Design Single IGBTMOD™
 450 Amperes/250 Volts

