



虹冠電子工業股份有限公司
Champion Microelectronic Corporation

Specialized in Integrated High Efficient Switching Power Management Solutions
高整合高效率交換型電源管理方案之專業 I C 設計



上海台永商貿有限公司

SHANGHAI TAIYONG CO.,LTD

上海市普陀區桐柏路 165 弄 1 號 101-103 室

(上海)TEL:86-21-59512136

(上海)FAX:86-21-59512123

E-mail: shanghai@shanghai-taiyong.com

E-mail: shanghai@ynv-gsm.com

東莞辦事處

SHANGHAI TAIYONG CO.,LTD

東省東莞市長安鎮烏沙江貝村同和四巷 15 號

(東莞) TEL:86-769-5373287

(東莞) FAX:86-769-5373286

E-mail: dong-guan@shanghai-taiyong.com

E-mail: dong-guan@ynv-gsm.com

GENERAL DESCRIPTION

This of PWM modulator provides a complete pulse width modulation system in a single monolithic integrated circuit. This device includes a 5V reference accurate to $\pm 1\%$, two independent amplifiers usable for both voltage and current sensing, an externally synchronizable oscillator with its linear ramp generator, and two-uncommitted transistor output switches. These two outputs may be operated either in parallel for single-ended operation or alternating for push-pull applications with an externally controlled dead-band. This unit is internally protected against double-pulsing of a single output or from extraneous output signals when the input supply voltage is below minimum.

The CM494 contains an on-chip 39V zener diode for high-voltage applications where V_{cc} would be greater than 40V, and a buffered output steering control that overrides the internal control of the pulse steering flip-flop.

FEATURES

- ◆ Dual uncommitted 40V, 200mA output transistors.
- ◆ 1% accurate 5V reference.
- ◆ Dual error amplifiers.
- ◆ Wide range, variable dead time.
- ◆ Single-ended or push-pull operation.
- ◆ Under-voltage lockout with hysteresis.
- ◆ Double pulse protection.
- ◆ Master or slave oscillator operation.

APPLICATIONS

- ◆ Linear Regulators
- ◆ Adjustable Supplies
- ◆ Switching Power Supplies
- ◆ Battery Operated Computers
- ◆ Instrumentation
- ◆ Computer Disk Drives

PIN CONFIGURATION

16-PIN PDIP/SOP
(Top View)

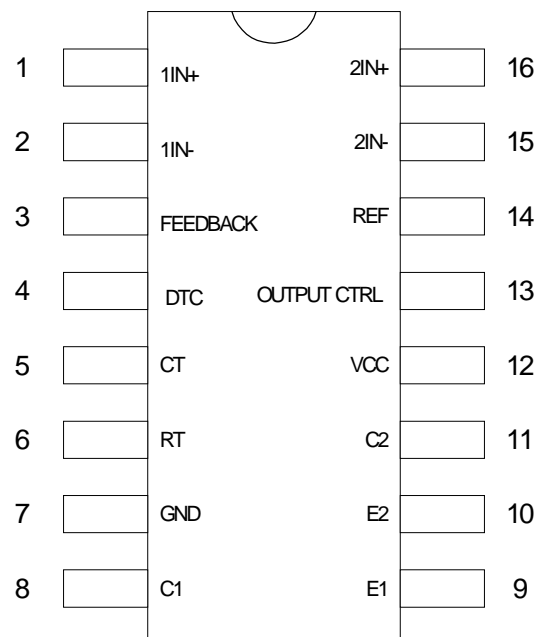

BLOCK DIAGRAM

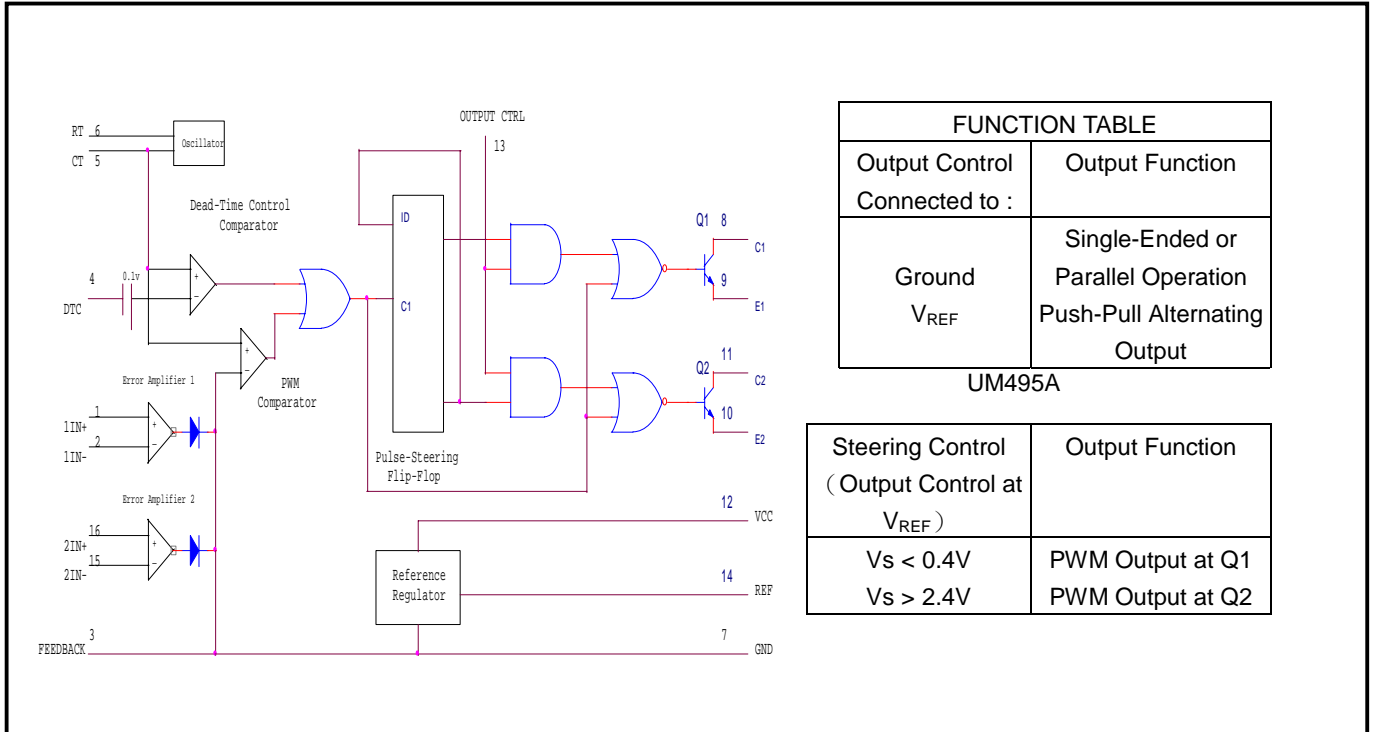

ORDERING INFORMATION

Part Number	Temperature Range	Package
CM494CP	0°C to 70°C	16-PIN DPIP (P16)
CM494CS	0°C to 70°C	16-PIN SOP (S16)

ABSOLUTE MAXIMUM RATINGS

Supply voltage, V_{CC} (Note 2).....	45V
Amplifier input voltages.....	$V_{CC} + 0.3V$
Collector output voltage.....	41V
Collector output current.....	250mA
Continuous total dissipation.....	1000mW
@ (or below) 25°C free air temperature range (Note 3)	
Storage temperature range.....	-65°C to + 150°C
Lead temperature 1 / 16"(1.6mm) from case for 60 seconds, J package.....	300°C
Lead temperature 1 / 16"(1.6mm) from case for 10 seconds, N package.....	260°C

Note 1: Over operating free air temperature range unless otherwise noted.

Note 2: All voltage values are with respect to network ground terminal 3.

Note 3: Consult package section of data book regarding thermal specification and limitation of package.

RECOMMENDED OPERATING CONDITION

Supply voltage V_{CC}	7V to 40V
Error amplifier input voltages.....	-0.3 to $V_{CC}-2V$
Collector output voltage.....	.40V
Collector output current (each transistor)...	200mA
Current into feedback terminal.....	0.3mA
Timing capacitor, C_T ...	0.47nF to 10,000nF
Timing resistor, R_T	1.8k Ω to 500k Ω
Oscillator Frequency.....	1kHz to 300kHz
Operating free air temperature	
UC494A, UC495A.....	-55°C to + 125°C
UC494AC, UC495AC.....	0°C to +70°C

ELECTRICAL CHARACTERISTICS: Unless otherwise stated, over recommended operating free-air temperature range. $V_{CC} = 15V$, $f = 10KHz$, $T_A = T_J$.

PARAMETER	TEST CONDITIONS	MIN	TYP	MAX	UNITS
Reference Section					
Output voltage V_{REF}	$I_o = 1mA$, $T_A = 25^\circ C$	4.75	5	5.25	V
Input regulation	$V_{CC} = 7V$ to $40V$		2	25	mV
Output regulation	$I_o = 1mA$ to $10mA$		1	15	mV
Output voltage over temperature	$\Delta T_A = \text{Min. to Max}$	4.90		5.10	V
Short circuit output current	$V_{REF} = 0$, $T_A = 25^\circ C$	10	35	50	mA
Oscillator Section					
Frequency (Note 2)	$C_T = 0.01\mu F$, $R_T = 12\Omega$		10		kHz
Standard deviation of frequency (Note 3)	All values of V_{CC} , C_T , R_T , T_A		10		%
Frequency change with voltage	$V_{CC} = 7V$ to $40V$, $T_A = 25^\circ C$		0.1		%
Frequency change with temperature	$C_T = 0.01\mu F$, $R_T = 12k\Omega$, $\Delta T_A = \text{Min. to Max}$			2	%
Deadtime Control Section (Output control connected to V_{REF})					
Input bias current (Pin 4)	$V_{(PIN 4)} = 0V$ to $5.25V$		-2	-10	μA
Maximum duty-cycle (each output)	$V_{(PIN 4)} = 0V$	45			%
Deadtime control Section (cont.) (Output control connected to V_{REF})					
Input threshold voltage (Pin 4)	Zero duty-cycle		3	3.3	V
	Maximum duty-cycle	0			V
Amplifier Section					
Input offset voltage	$V_O (PIN 3) = 2.5V$		2	10	mV
Input offset current	$V_O (PIN 3) = 2.5V$		25	250	nA
Input bias current	$V_O (PIN 3) = 2.5V$		-0.2	-1	μA
Common-mode input voltage range	$V_{CC} = 7V$ to $40V$.03 to $V_{CC} - 2$			V
Open loop voltage gain	$\Delta V_o = 3V$, $V_o = 0.5V$ to $3.5V$	70	95		dB
Unity gain bandwidth			800		kHz
Common-mode rejection ratio	$V_{CC} = 40V$, $T_A = 25^\circ C$	65	80		dB
Output sink current (Pin 3)	$V_{ID} = -15mV$ to $-5V$, $V_{(PIN 3)} = 3.5V$	0.3	0.7		mA
Output Source current (Pin 3)	$V_{ID} = -15mV$ to $5V$, $V_{(PIN 3)} = 3.5V$	-2			mA

ELECTRICAL CHARACTERISTICS: Unless otherwise stated, over recommended operating free-air temperature range. $V_{CC} = 15V$, $f = 10KHz$, $T_A = T_J$

PARAMETER	TEST CONDITIONS	MIN	TYP	MAX	UNITS	
Output Section						
Collector off-state current	$V_{CE} = 40V, V_{CC} = 40V$		2	100	μA	
Emitter off-state current	$V_{CC} = V_C = 40V, V_E = 0$			-100	μA	
Collector-Emitter Saturation voltage	Common-Emitter $V_E = 0, I_C = 200mA$		1.1	1.3	V	
	Emitter-follower $V_C = 15V, I_E = -200mA$		1.5	2.5	V	
Output control input current	$V_I = V_{REF}$			3.5	mA	
PWM Comparator Section						
Input threshold voltage (Pin 3)	Zero duty-cycle		4	4.5	V	
Input sink current (Pin 3)	$V_{(Pin 3)} = 0.7V$	0.3	0.7		mA	
Steering Control						
Input current	$V_{(Pin 13)} = 0.4V, Q_1 \text{ ACTIVE}$			-200	μA	
	$V_{(Pin 13)} = 2.4V, Q_2 \text{ ACTIVE}$			300	μA	
Deadband			500		mA	
Zener Diode Circuit (UC495A)						
Breakdown voltage	$V_{CC} = 45V, I_Z = 2mA$	36	39	.45	V	
Sink current	$V_{(Pin 15)} = 1V$	0.2	0.3	0.6	mA	
Total Device						
Standby supply current	Pin 6 at V_{REF} , All other inputs and outputs open	$V_{CC} = 15V$		6	10	mA
		$V_{CC} = 40V$		9	15	mA
Under voltage lockout		3.5		6.5	V	
Hysteresis			300		mV	
Switching Characteristics ($T_A = 25^\circ C$)						
Output voltage rise time	Common-emitter configuration		100	200	ns	
Output voltage fall time	$R_L = 68\Omega, C_L = 15pF$		25	100	ns	
Output voltage rise time	Emitter-follower configuration		100	200	ns	
Output voltage fall time	$R_L = 68\Omega, C_L = 15pF$		40	100	ns	

Note 1: Duration of the short circuit should not exceed one second.

Note 2: Frequency for other values of C_T and R_T is approximately $f = 1.1/RTCT$

Note 3: Standard deviation is measure of the statistical distribution about the mean as derived from the formula:

$$\sigma = \sqrt{\frac{\sum_{n=1}^n (X_n - X)^2}{n-1}}$$

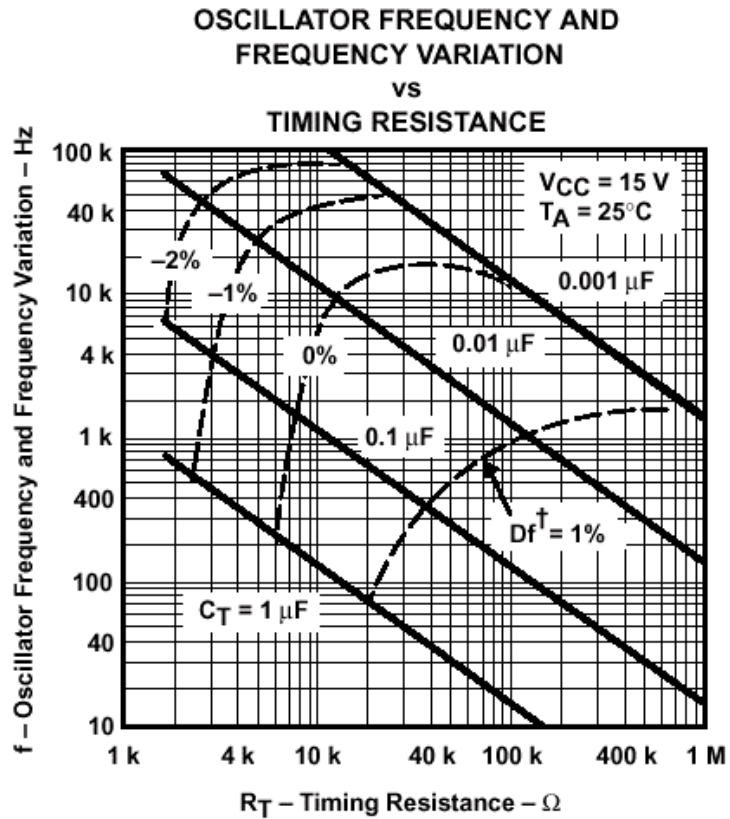
TYPICAL CHARACTERISTICS

Frequency variation (Δf) is the change in oscillator frequency that occurs over the full temperature range.

PACKAGE DIMENSION

16-PIN PDIP (P16)

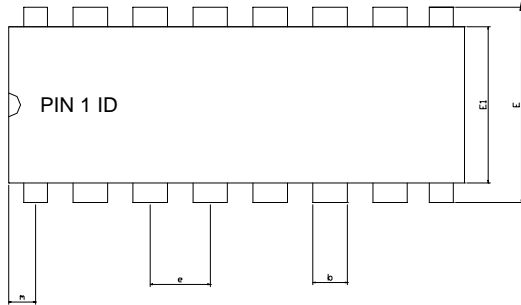

SYMBOLS	DIMENSIONS IN MILLIMETERS			DIMENSIONS IN INCHS		
	MIN	NOM	MAX	MIN	NOM	MAX
A	---	---	4.32	---	---	0.170
A1	0.38	---	---	0.015	---	---
b	1.40	---	1.65	0.055	---	0.065
b1	0.40	---	0.56	0.016	---	0.022
C	0.20	---	0.31	0.008	---	0.012
D	18.79	---	19.31	0.740	---	0.760
E	7.49	---	8.26	0.295	---	0.325
E1	6.09	---	6.61	0.240	---	0.260
e	---	2.54	---	---	0.100	---
L	3.18	---	---	0.125	---	---
m	0.50	---	---	0.02	---	---
θ	0°	---	15°	0°	---	15°

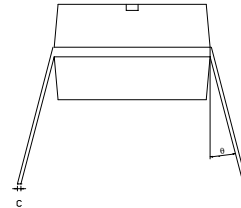
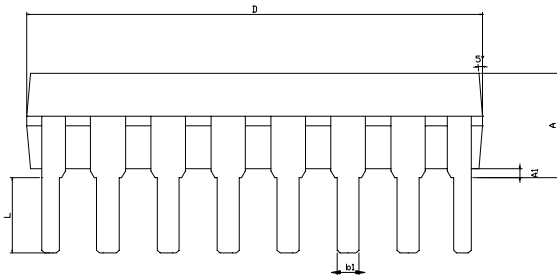

16-PIN SOP (S16)

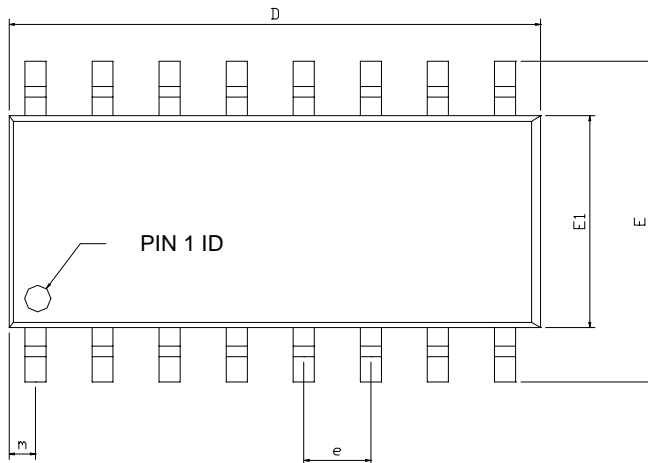

SYMBOLS	DIMENSIONS IN MILLIMETERS			DIMENSIONS IN INCHS		
	MIN	NOM	MAX	MIN	NOM	MAX
A1	0.05	---	0.15	0.002	---	0.006
A2	1.40	---	1.55	0.055	---	0.061
b	0.30	---	0.51	0.012	---	0.020
C	0.15	---	0.26	0.006	---	0.010
D	9.80	---	10.06	0.386	---	0.396
E	5.79	---	6.20	0.228	---	0.244
E1	3.76	---	4.01	0.148	---	0.158
e	---	1.27	---	---	0.050	---
L	0.38	---	0.69	0.015	---	0.035
m	0.43	---	0.69	0.017	---	0.027
θ	0	---	8	0	---	8

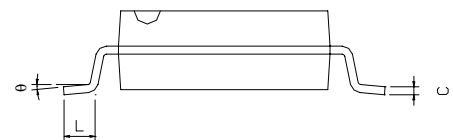
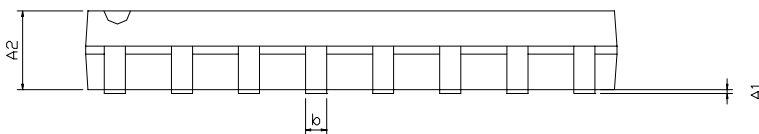

上海台永商貿有限公司



SHANGHAI SALES DEPT.

上海台永商貿有限公司
SHANGHAI TAIYONG CO.,LTD
上海市普陀區桐柏路 165 弄 1 號
101-103 室

(上海)TEL:86-21-59512136

(上海)FAX:86-21-59512123

E-mail:

shanghai@shanghai-taiyong.com

E-mail:

shanghai@vny-gsm.com



INVERTER LAB & Sales Dept . DONG-GUAN,CHINA

東省東莞市長安鎮烏沙江貝村同和
四巷 15 號

(東莞) TEL:86-769-5373287

(東莞) FAX:86-769-5373286

E-mail:

dong-guan@shanghai-taiyong.com

E-mail:

dong-guan@vny-gsm.com



CERAMIC/SURGE ABSORBER SHANGHAI,CHINA



DIODES LAB HANGZHOU,CHINA



CERAMIC/PZT SHINCHU,TAIWAN



DC POWER LAB TAIPEI,TAIWAN