

### Chopper IGBTMOD™ U-Series Module 50 Amperes/1200 Volts

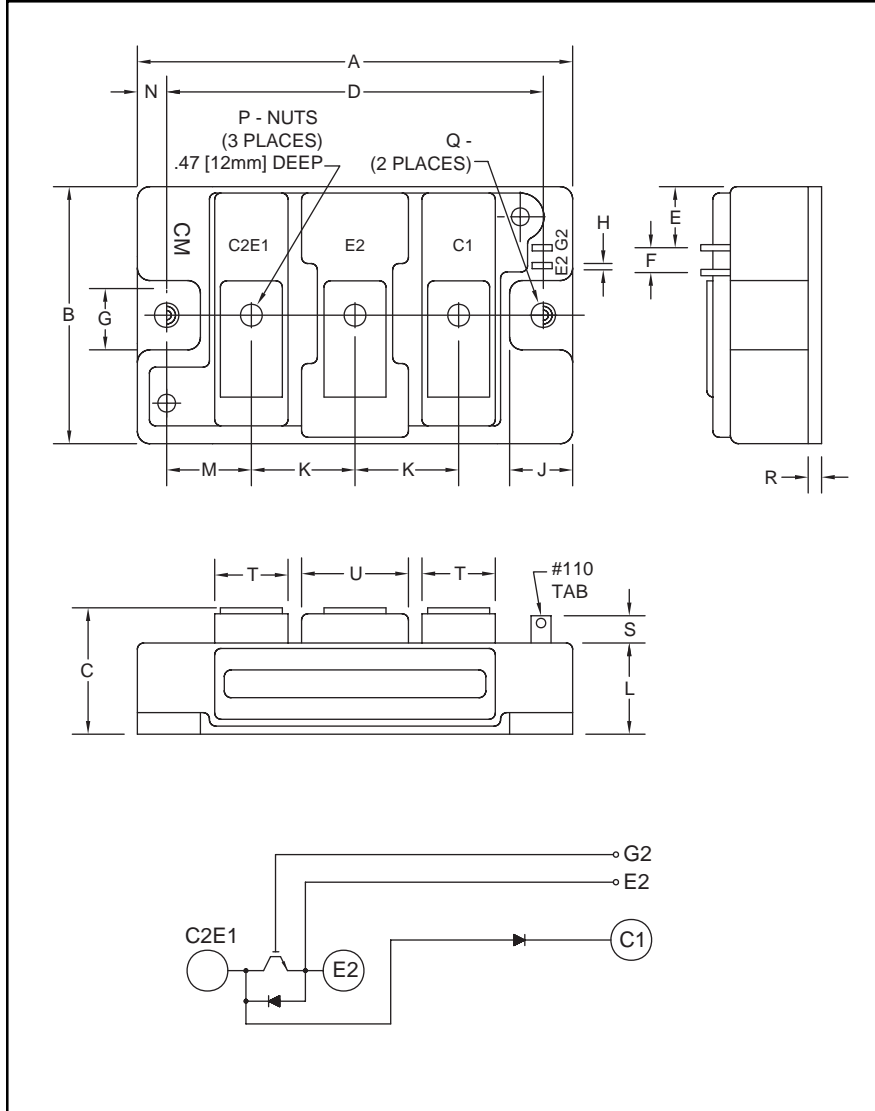

Outline Drawing and Circuit Diagram

Dimensions	Inches	Millimeters
A	3.70	94.0
B	1.89	48.0
C	1.18 +0.04/-0.02	30.0 +1.0/-0.5
D	3.15±0.01	80.0±0.25
E	0.43	11.0
F	0.16	4.0
G	0.51	13.0
H	0.02	0.5
J	0.53	13.5
K	0.91	23.0

Dimensions	Inches	Millimeters
L	0.84	21.2
M	0.67	17.0
N	0.28	7.0
P	M5	M5
Q	0.26 Dia.	6.5 Dia.
R	0.02	4.0
S	0.30	7.5
T	0.63	16.0
U	0.98	25.0



#### Description:

Powerex Chopper IGBTMOD™ Modules are designed for use in switching applications. Each module consists of one IGBT Transistor having a reverse-connected super-fast recovery free-wheel diode and an anode-collector connected super-fast recovery free-wheel diode. All components and interconnects are isolated from the heat sinking baseplate, offering simplified system assembly and thermal management.

#### Features:

- Low Drive Power
- Low  $V_{CE(sat)}$
- Discrete Super-Fast Recovery Free-Wheel Diode
- High Frequency Operation (15-20kHz)
- Isolated Baseplate for Easy Heat Sinking

#### Applications:

- DC Motor Control
- Boost Regulator

#### Ordering Information:

Example: Select the complete module number you desire from the table - i.e. CM50E3U-24H is a 1200V ( $V_{CES}$ ), 50 Ampere Chopper IGBTMOD™ Power Module.

Type	Current Rating Amperes	$V_{CES}$ Volts (x 50)
CM	50	24

**CM50E3U-24H**

**Chopper IGBTMOD™ U-Series Module**

50 Amperes/1200 Volts

**Absolute Maximum Ratings,  $T_j = 25\text{ }^\circ\text{C}$  unless otherwise specified**

Ratings	Symbol	CM50E3U-24H	Units
Junction Temperature	$T_j$	-40 to 150	$^\circ\text{C}$
Storage Temperature	$T_{\text{stg}}$	-40 to 125	$^\circ\text{C}$
Collector-Emitter Voltage (G-E SHORT)	$V_{\text{CES}}$	1200	Volts
Gate-Emitter Voltage (C-E SHORT)	$V_{\text{GES}}$	$\pm 20$	Volts
Collector Current ( $T_c = 25^\circ\text{C}$ )	$I_c$	50	Amperes
Peak Collector Current	$I_{\text{CM}}$	100*	Amperes
Emitter Current** ( $T_c = 25^\circ\text{C}$ )	$I_E$	50	Amperes
Peak Emitter Current**	$I_{\text{EM}}$	100*	Amperes
Maximum Collector Dissipation ( $T_c = 25^\circ\text{C}$ , $T_j \leq 150^\circ\text{C}$ )	$P_c$	400	Watts
Mounting Torque, M5 Main Terminal	–	31	in-lb
Mounting Torque, M6 Mounting	–	40	in-lb
Weight	–	310	Grams
Isolation Voltage (Main Terminal to Baseplate, AC 1 min.)	$V_{\text{iso}}$	2500	Volts

\* Pulse width and repetition rate should be such that the device junction temperature ( $T_j$ ) does not exceed  $T_{j(\text{max})}$  rating.

\*\*Represents characteristics of the anti-parallel, emitter-to-collector free-wheel diode (FWDi).

**Static Electrical Characteristics,  $T_j = 25\text{ }^\circ\text{C}$  unless otherwise specified**

Characteristics	Symbol	Test Conditions	Min.	Typ.	Max.	Units
Collector-Cutoff Current	$I_{\text{CES}}$	$V_{\text{CE}} = V_{\text{CES}}$ , $V_{\text{GE}} = 0\text{V}$	–	–	1	mA
Gate Leakage Voltage	$I_{\text{GES}}$	$V_{\text{GE}} = V_{\text{GES}}$ , $V_{\text{CE}} = 0\text{V}$	–	–	0.5	$\mu\text{A}$
Gate-Emitter Threshold Voltage	$V_{\text{GE(th)}}$	$I_c = 5\text{mA}$ , $V_{\text{CE}} = 10\text{V}$	4.5	6	7.5	Volts
Collector-Emitter Saturation Voltage	$V_{\text{CE(sat)}}$	$I_c = 50\text{A}$ , $V_{\text{GE}} = 15\text{V}$ , $T_j = 25^\circ\text{C}$	–	2.9	3.7	Volts
		$I_c = 50\text{A}$ , $V_{\text{GE}} = 15\text{V}$ , $T_j = 125^\circ\text{C}$	–	2.85	–	Volts
Total Gate Charge	$Q_G$	$V_{\text{CC}} = 600\text{V}$ , $I_c = 50\text{A}$ , $V_{\text{GE}} = 15\text{V}$	–	187	–	nC
Emitter-Collector Voltage**	$V_{\text{EC}}$	$I_E = 50\text{A}$ , $V_{\text{GE}} = 0\text{V}$	–	–	3.2	Volts
Emitter-Collector Voltage	$V_{\text{FM}}$	$I_F = 50\text{A}$ , Clamp Diode Part	–	–	3.2	Volts

\*\*Represents characteristics of the anti-parallel, emitter-to-collector free-wheel diode (FWDi).

**Dynamic Electrical Characteristics,  $T_j = 25\text{ }^\circ\text{C}$  unless otherwise specified**

Characteristics	Symbol	Test Conditions	Min.	Typ.	Max.	Units	
Input Capacitance	$C_{\text{ies}}$		–	–	7.5	nf	
Output Capacitance	$C_{\text{oes}}$	$V_{\text{CE}} = 10\text{V}$ , $V_{\text{GE}} = 0\text{V}$	–	–	2.6	nf	
Reverse Transfer Capacitance	$C_{\text{res}}$		–	–	1.5	nf	
Resistive	Turn-on Delay Time	$t_{\text{d(on)}}$	$V_{\text{CC}} = 600\text{V}$ , $I_c = 50\text{A}$ ,	–	–	80	ns
Load	Rise Time	$t_r$	$V_{\text{GE1}} = V_{\text{GE2}} = 15\text{V}$ ,	–	–	200	ns
Switch	Turn-off Delay Time	$t_{\text{d(off)}}$	$R_G = 6.3\Omega$ , Resistive	–	–	150	ns
Times	Fall Time	$t_f$	Load Switching Operation	–	–	350	ns
Diode Reverse Recovery Time**	$t_{\text{rr}}$	$I_E = 50\text{A}$ , $di_E/dt = -100\text{A}/\mu\text{s}$	–	–	300	ns	
Diode Reverse Recovery Charge**	$Q_{\text{rr}}$	$I_E = 50\text{A}$ , $di_E/dt = -100\text{A}/\mu\text{s}$	–	0.28	–	$\mu\text{C}$	
Diode Reverse Recovery Time	$t_{\text{rr}}$	$I_F = 50\text{A}$ , Clamp Diode Part,	–	–	300	ns	
Diode Reverse Recovery Charge	$Q_{\text{rr}}$	$di_F/dt = -100\text{A}/\mu\text{s}$	–	0.28	–	$\mu\text{C}$	

\*\*Represents characteristics of the anti-parallel, emitter-to-collector free-wheel diode (FWDi).

**CM50E3U-24H**  
**Chopper IGBTMOD™ U-Series Module**  
 50 Amperes/1200 Volts

**Thermal and Mechanical Characteristics,  $T_j = 25^\circ\text{C}$  unless otherwise specified**

Characteristics	Symbol	Test Conditions	Min.	Typ.	Max.	Units
Thermal Resistance, Junction to Case	$R_{th(j-c)Q}$	Per IGBT	–	–	0.31	$^\circ\text{C/W}$
Thermal Resistance, Junction to Case	$R_{th(j-c)D}$	Per FWDi	–	–	0.7	$^\circ\text{C/W}$
Thermal Resistance, Junction to Case	$R_{th(j-c)}$	Clamp Diode Part	–	–	0.7	$^\circ\text{C/W}$
Contact Thermal Resistance	$R_{th(c-f)}$	Per Module, Thermal Grease Applied	–	0.035	–	$^\circ\text{C/W}$

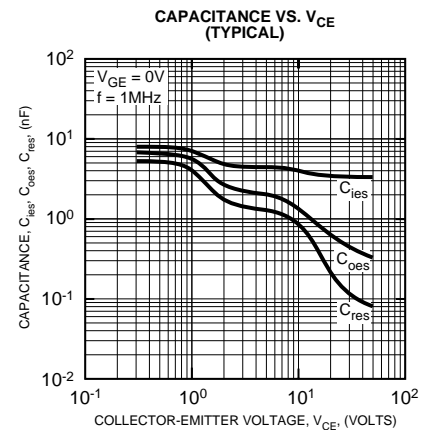
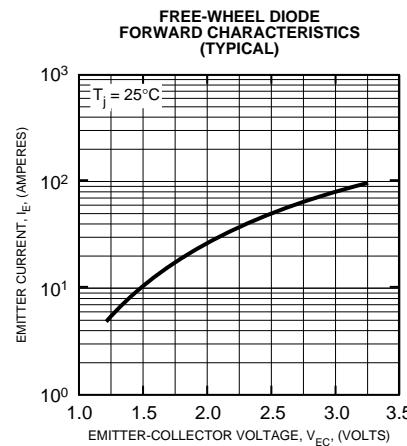
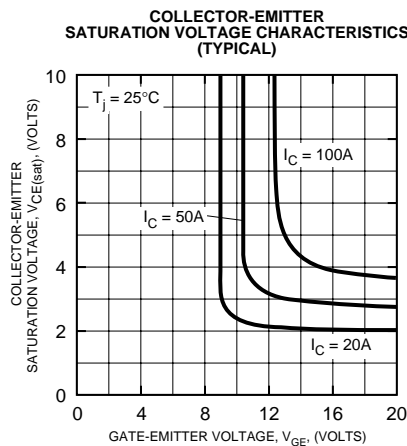
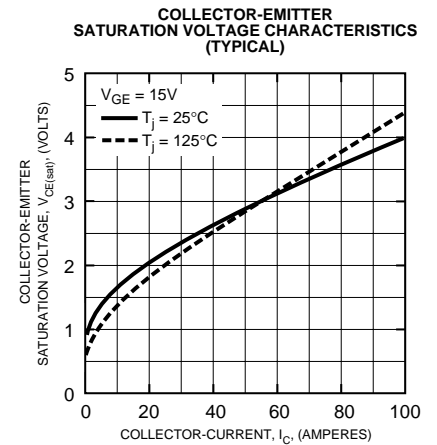
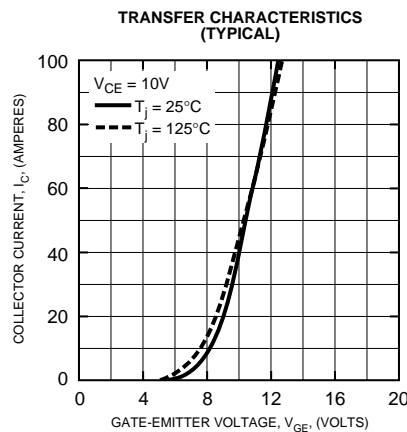
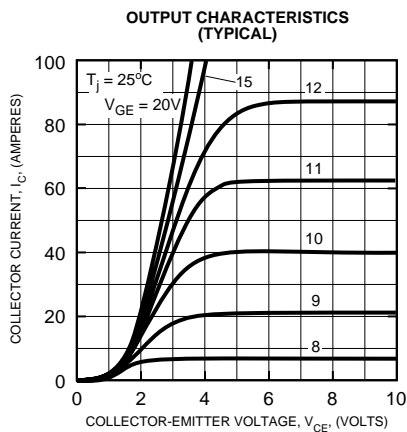

**CM50E3U-24H**  
**Chopper IGBTMOD™ U-Series Module**  
 50 Amperes/1200 Volts

