

## 250mA SmartOR™ Regulator with $V_{AUX}$ Switch

### Features

- Automatic detection of  $V_{CC}$  input supply
- Glitch-free output during supply transitions
- Built-in hysteresis during supply selection
- 250mA output maximum load current
- Fully integrated  $V_{AUX}$  switch
- Overload current protection
- Short circuit current protection
- Operates from either  $V_{CC}$  or  $V_{AUX}$
- 8-pin SOIC package

### Applications

- PCI adapter cards
- Network Interface Cards (NIC's)
- Dual power systems
- Systems with standby capabilities

### Product Description

The California Micro Devices' SmartOR™ CMPWR101 is a low dropout regulator that delivers up to 250mA of load current at a fixed 3.3V output. An internal threshold level (typically 4.1V) is used to prevent the regulator from being operated below dropout voltage. The device continuously monitors the input supply and will automatically disable the regulator when  $V_{CC}$  falls below the threshold level. When the regulator is disabled, a low impedance, fully integrated switch is enabled which allows the output to be directly powered from an auxiliary 3.3V supply.

When  $V_{CC}$  is restored to a level above the select threshold, the low impedance switch is disabled and the regulator is once again enabled.

All the necessary control circuitry needed to provide a smooth and automatic transition between the supplies has been incorporated. This allows  $V_{CC}$  to be dynamically switched without loss of output voltage.

An output logic signal, DRIVE, is active LOW whenever the internal regulator is disabled.

### PIN DIAGRAM AND APPLICATION CIRCUIT

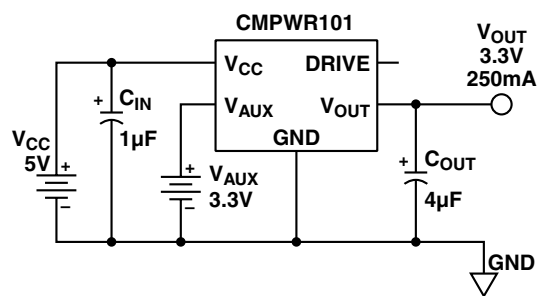
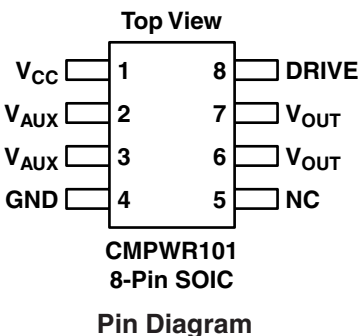

**Typical Application Circuit**

### STANDARD PART ORDERING INFORMATION

Package		Ordering Part Number		
Pins	Style	Tubes	Tape & Reel	Part Marking
8	SOIC	CMPWR101S/T	CMPWR101S/R	CMPWR101S

ABSOLUTE MAXIMUM RATINGS		
Parameter	Rating	Unit
ESD Protection (HBM)	2000	V
V <sub>CC</sub> , V <sub>OUT</sub> Voltages	6.0, GND -0.5	V
Drive Logic Voltage	V <sub>CC</sub> + 0.5, GND -0.5	V
V <sub>AUX</sub> Input Voltage	4.0, GND -0.5	V
Temperature: Storage	-40 to 150	°C
Operating Ambient	0 to 70	°C
Operating Junction	0 to 125	°C
Power Dissipation (Note 1)	0.5	W

OPERATING CONDITIONS		
Parameter	Range	Unit
V <sub>CC</sub>	5 ± 0.5	V
V <sub>AUX</sub>	3.3 ± 0.3	V
Temperature (Ambient)	0 to 70	°C
Load Current	0 to 250	mA
CEXT	4.7 ± 20%	µF

ELECTRICAL OPERATING CHARACTERISTICS (over operating conditions unless specified otherwise)						
Symbol	Parameter	Conditions	MIN	TYP	MAX	UNIT
V <sub>OUT</sub>	Regulator Output Voltage	0mA < I <sub>LOAD</sub> < 250mA	3.135	3.30	3.465	V
I <sub>LIM</sub>	Regulator Current Limit		275			mA
V <sub>CCSEL</sub>	Select Voltage	Regulator Enabled		4.30	4.45	V
V <sub>CCDES</sub>	Deselect Voltage	Regulator Disabled	3.90	4.10		V
V <sub>CCHYST</sub>	Hysteresis Voltage (Note 2)	Hysteresis		0.20		V
V <sub>R LOAD</sub>	Load Regulation	V <sub>CC</sub> = 5V, I <sub>LOAD</sub> = 5 to 250mA		20		mV
V <sub>R LINE</sub>	Line Regulation	V <sub>CC</sub> = 4.5V to 5.5V, I <sub>LOAD</sub> = 5mA		2		mV
R <sub>SWITCH</sub>	Auxiliary Switch Resistance	V <sub>CCDES</sub> > V <sub>CC</sub> , V <sub>AUX</sub> = 3.3V		0.25	0.4	Ω
I <sub>RCC</sub>	V <sub>CC</sub> Pin Reverse Leakage	V <sub>AUX</sub> = 3.3V, V <sub>CC</sub> = 0V		2	50	µA
I <sub>RAUX</sub>	V <sub>AUX</sub> Pin Reverse Leakage	V <sub>AUX</sub> = 0V, V <sub>CC</sub> = 5V		2	50	µA
I <sub>GND</sub>	Ground Current	V <sub>CC</sub> < V <sub>CCDES</sub> , I <sub>LOAD</sub> = 0mA		0.2	0.4	mA
		V <sub>CC</sub> > V <sub>CCSEL</sub> , I <sub>LOAD</sub> = 0mA		0.6	1.0	mA
		V <sub>CC</sub> > V <sub>CCSEL</sub> , I <sub>LOAD</sub> = 250mA		0.7	1.2	mA
I <sub>AUX</sub>	V <sub>AUX</sub> Supply Current	V <sub>AUX</sub> > V <sub>CC</sub>		0.2	0.4	mA
		V <sub>CC</sub> > V <sub>AUX</sub>		0.02	0.1	mA
R <sub>OH</sub>	Drive Pull-up Resistance	R <sub>PULLUP</sub> to V <sub>CC</sub> , V <sub>CC</sub> > V <sub>CCSEL</sub>		4.0	8.0	kΩ
R <sub>OL</sub>	Drive Pull-down Resistance	R <sub>PULLDOWN</sub> to GND, V <sub>CCDES</sub> > V <sub>CC</sub>		0.1	0.4	kΩ

**Note 1:** The power rating is based on a printed circuit board heat spreading capability equivalent to 2 square inches of copper connected to the GND pins. Typical multi-layer boards using power plane construction will provide this heat spreading ability without the need for additional dedicated copper area. (Please consult with factory for thermal evaluation assistance).

**Note 2:** The hysteresis defines the maximum level of acceptable disturbance on V<sub>CC</sub> during switching. It is recommended that the V<sub>CC</sub> source impedance be kept below 0.25Ω to ensure the switching disturbance remains below the hysteresis during select/deselect transitions. An input capacitor may be required to help minimize the switching transient.

### Interface Signals

$V_{CC}$  is the power source for the internal regulator and is monitored continuously by an internal controller circuit.

Whenever  $V_{CC}$  exceeds  $V_{CCSEL}$  (4.25V typically), the internal regulator will be enabled and deliver a fixed 3.3V at  $V_{OUT}$ . When  $V_{CC}$  falls below  $V_{CCDES}$  (4.10V typically), the regulator will be disabled.

Internal loading on this pin is typically 0.6mA when the regulator is enabled, which reduces to 0.1mA whenever the regulator is disabled. If  $V_{CC}$  falls below the voltage on the  $V_{AUX}$  pin, the  $V_{CC}$  loading will further reduce to only a few microamperes.

During a  $V_{CC}$  power-up or power-down sequence, there will be an effective step increase in  $V_{CC}$  line current when the regulator is enabled/disabled. This line current transient will cause a voltage disturbance at the  $V_{CC}$  pin. The magnitude of the disturbance will be directly proportional to the effective power supply source impedance being delivered to the  $V_{CC}$  input.

A built-in hysteresis voltage of 150mV has been incorporated to minimize any chatter during supply changeover. It is recommended that the power supply connected to the  $V_{CC}$  input should have a source resistance of less than  $0.25\Omega$  to minimize the event of chatter during the enabling/disabling of the regulator.

If the  $V_{CC}$  pin is within a few inches of the main input filter, a capacitor may not be necessary. Otherwise an input filter capacitor in the range of  $1\mu F$  to  $10\mu F$  will help to lower the effective source impedance.

$V_{AUX}$  is the auxiliary power source. When selected, ( $V_{CC} < V_{CCDES}$ ), the auxiliary supply is directly connected to  $V_{OUT}$ , via the low impedance ( $0.3\Omega$  typically) fully integrated switch.

The internal loading on this pin is typically less than  $10\mu A$  and will increase to  $100\mu A$  if  $V_{CC}$  falls below the voltage on  $V_{AUX}$ .

When  $V_{AUX} = 0V$ , the  $V_{CCDES}$  voltage is inhibited which prevents the regulator from being disabled.

$V_{OUT}$  is the regulator output voltage connection used to power the load. An output capacitor of  $4.7\mu F$  is used to provide the necessary phase compensation, thereby preventing oscillation. The capacitor also helps to minimize the peak output disturbance during power supply changeover.

**DRIVE** is a CMOS output logic signal (Active Low) referenced to the  $V_{CC}$  supply. This output is taken low whenever the internal regulator is not enabled. This output is intended only as a control signal for external circuitry.

**GND** is the negative reference for all voltages. The current that flows in the ground connection is very low (typically 0.6mA) and has minimal variation over all load conditions.

**NC** is an unconnected pin which is electrically isolated from the internal circuitry.

PIN FUNCTIONS		
Pin	Symbol	Description
1	$V_{CC}$	Positive (5V) supply input for regulator. ( $V_{CC} > V_{CCSEL}$ )
2, 3	$V_{AUX}$	Auxiliary supply input is connected directly to the output via a low impedance when the regulator is disabled.
6, 7	$V_{OUT}$	Continuous output voltage (3.3V) is derived from either the internal regulator or low impedance switch connected to the auxiliary supply input.
8	DRIVE	Output Control Signal which is taken LOW whenever $V_{CC}$ is unavailable
4	GND	Negative reference for all voltages
5	NC	Unconnected pin which is electrically isolated from internal circuitry.

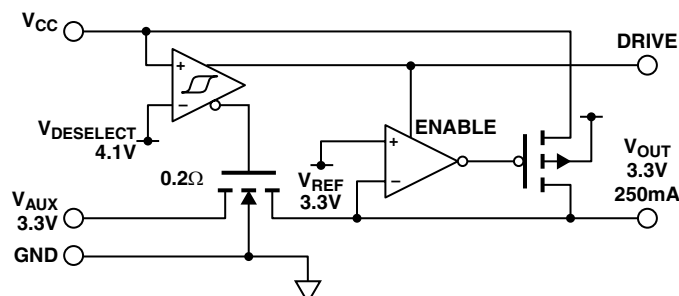

**Simplified Electrical Schematic**

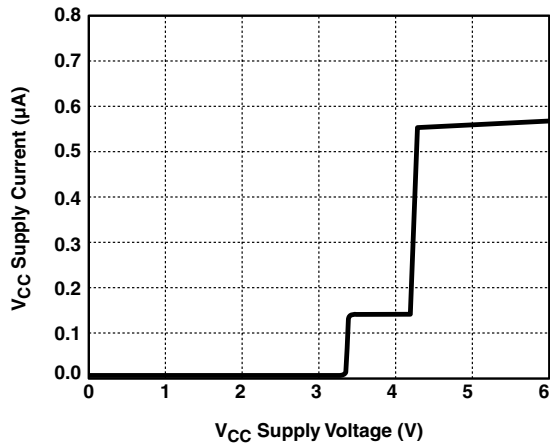
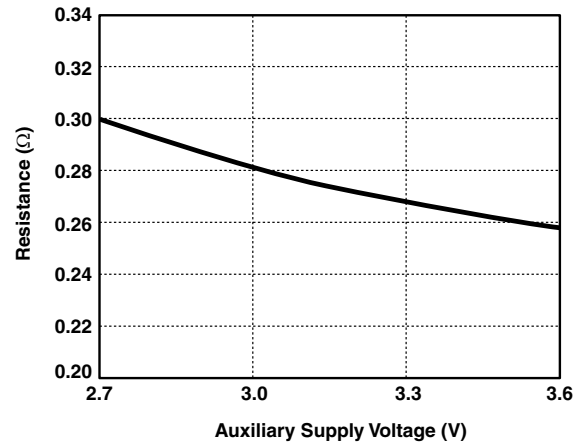
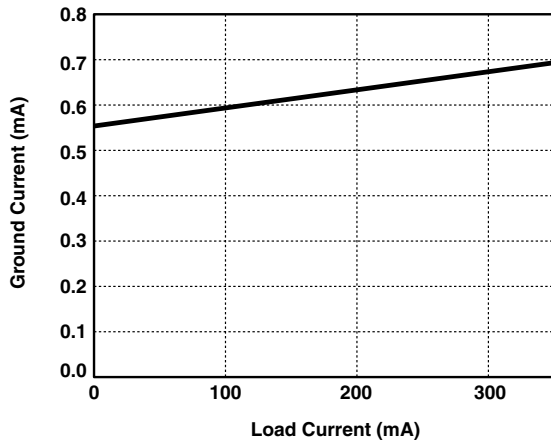
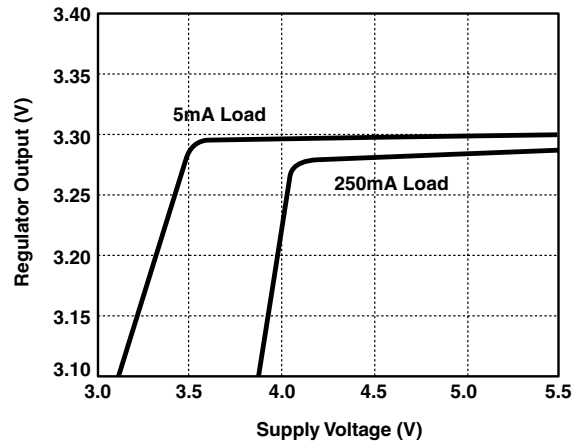
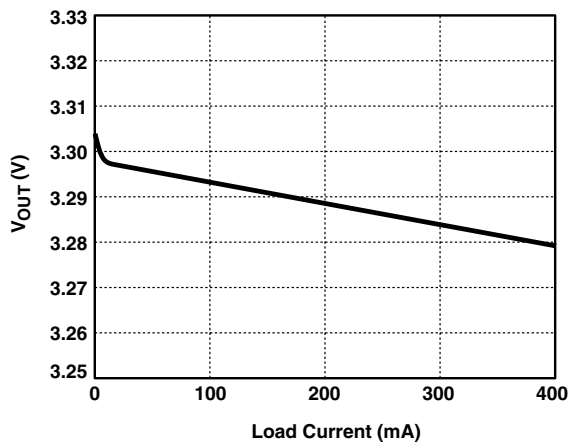
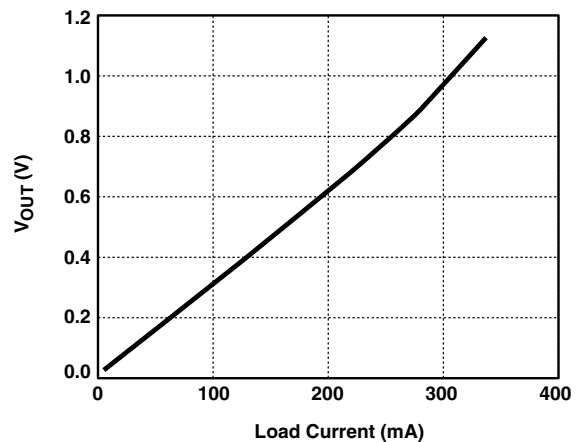
**Typical DC Characteristics** (nominal conditions unless specified otherwise)

**Figure 1. Supply Current vs Voltage ( $V_{AUX} = 3.3V$ )**

**Figure 2. Switch Resistance vs Supply Voltage**

**Figure 3. Ground Current vs Output Load**

**Figure 4. Line Regulation (1% and 100% rated load)**

**Figure 5. Load Regulation**

**Figure 6. Dropout Voltage with Load Current**

Typical Transient Characteristics (Supply source resistance set to 0.2Ω)

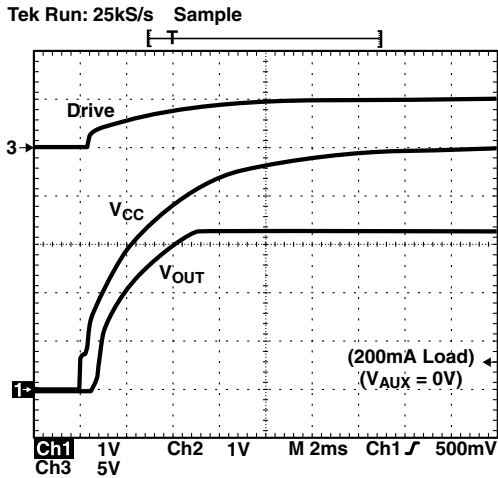

Figure 7.  $V_{CC}$  Cold start Power Up ( $V_{AUX} = 0V$ )

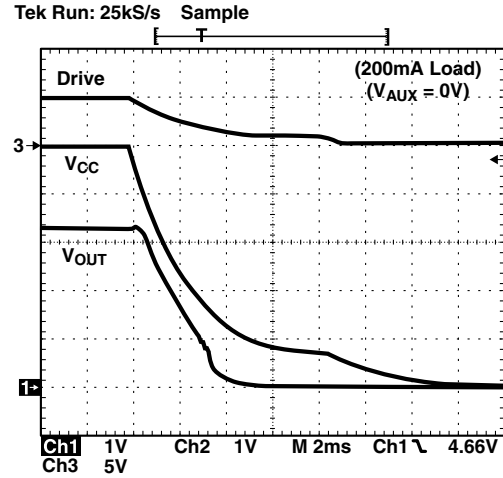

Figure 8.  $V_{CC}$  Complete Power Down ( $V_{AUX} = 0V$ )

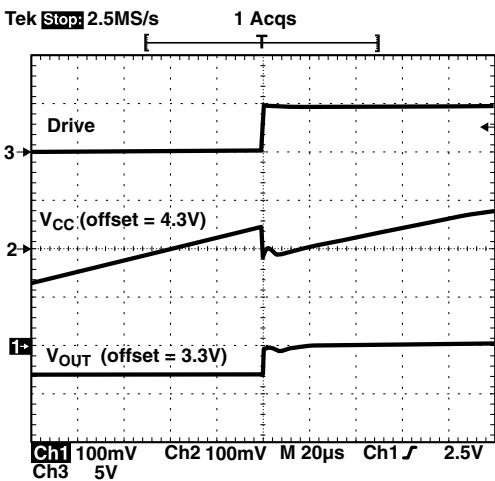

Figure 9.  $V_{CC}$  Power up ( $V_{AUX} = 3.3V$ )

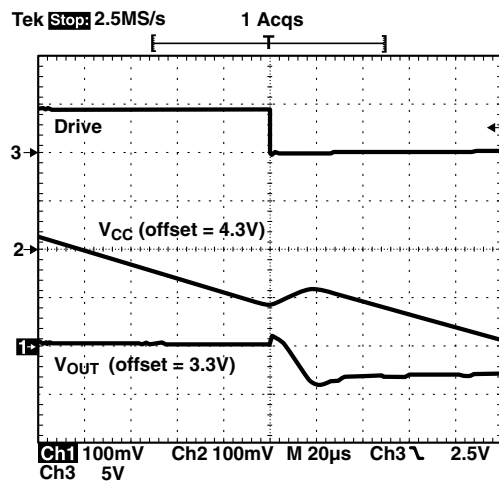

Figure 10.  $V_{CC}$  Power Down ( $V_{AUX} = 3.3V$ )

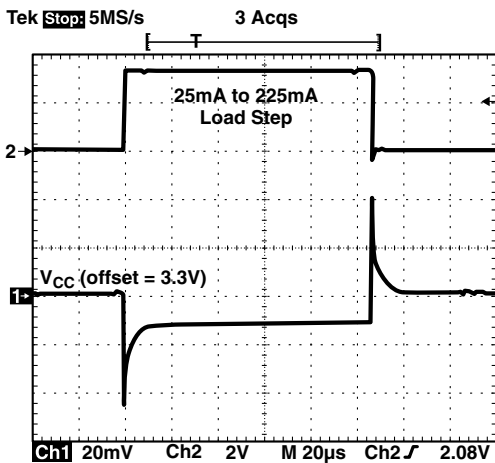

Figure 11. Load Transient (10% to 90%) Step Response

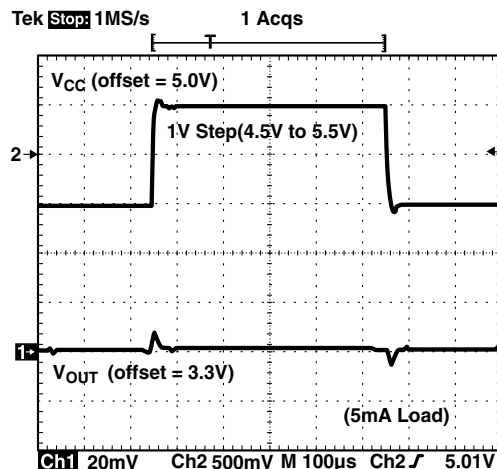

Figure 12. Line Transient (1Vpp) Step Response

### Typical Thermal Characteristics

The overall junction to ambient thermal resistance ( $\theta_{JA}$ ) for device power dissipation ( $P_D$ ) consists primarily of two paths in series. The first path is the junction to the case ( $\theta_{JC}$ ) which is defined by the package style, and the second path is case to ambient ( $\theta_{CA}$ ) thermal resistance which is dependent on board layout. The final operating junction temperature for any set of conditions can be estimated by the following thermal equation:

$$T_{JUNC} = T_{AMB} + P_D (\theta_{JC}) + P_D (\theta_{CA})$$

$$= T_{AMB} + P_D (\theta_{JA})$$

The CMPWR101 uses a standard SOIC package. When this package is mounted on a double sided printed circuit board with two square inches of copper allocated for “heat spreading”, the resulting overall  $\theta_{JA}$  is 85°C/W.

Based on maximum power dissipation of 0.43W (1.7V x 250mA) with an ambient of 70°C the resulting junction temperature will be:

$$T_{JUNC} = T_{AMB} + P_D (\theta_{JA})$$

$$= 70^\circ\text{C} + 0.43\text{W} (80^\circ\text{C/W})$$

$$= 70^\circ\text{C} + 37^\circ\text{C}$$

$$= 103^\circ\text{C}$$

Thermal characteristics were measured using a double sided board with two square inches of copper area connected to the GND pins for “heat spreading”.

Measurements showing performance up to junction temperature of 125°C were performed under light load conditions (5mA). This allows the ambient temperature to be representative of the internal junction temperature.

**Note:** The use of multi-layer board construction with power planes will further enhance the thermal performance of the package. In the event of no copper area being dedicated for heat spreading, a multi-layer board construction, using only the minimum size pad layout, will typically provide the CMPWR101 with an overall  $\theta_{JA}$  of 100°C/W, which allows up to 0.5W to be safely dissipated.

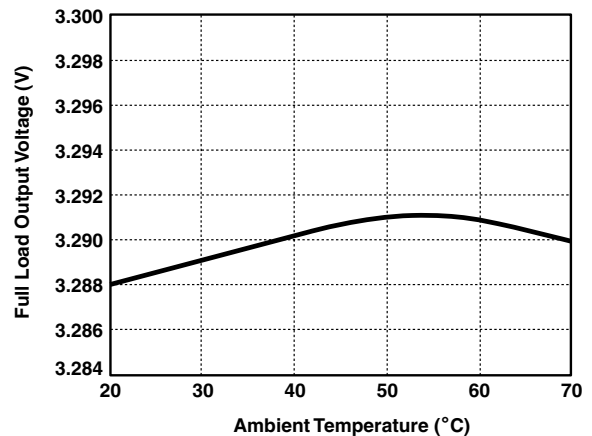

Figure 13. Regulator  $V_{OUT}$  vs  $T_{AMB}$  (250mA Load)

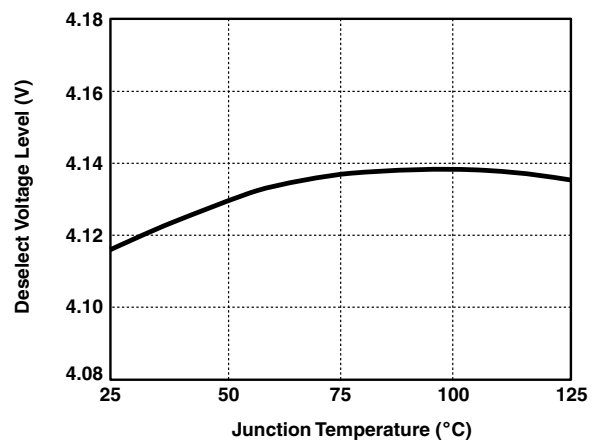

Figure 14. Deselect Threshold vs  $T_{JUNCT}$

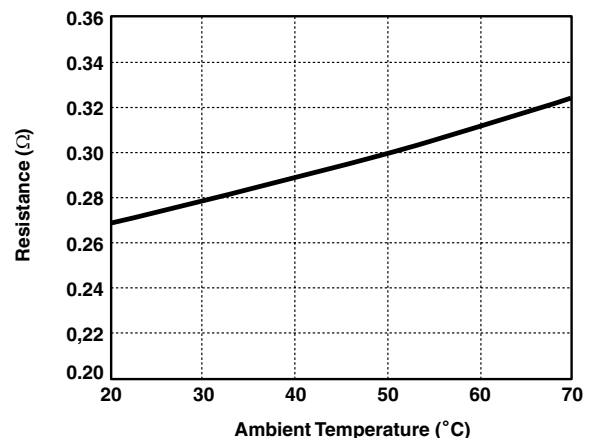

Figure 15. Switch Resistance vs Ambient Temperature