

# 3.96mm and 4mm Pitch Card Edge Connector

## CR7 Series

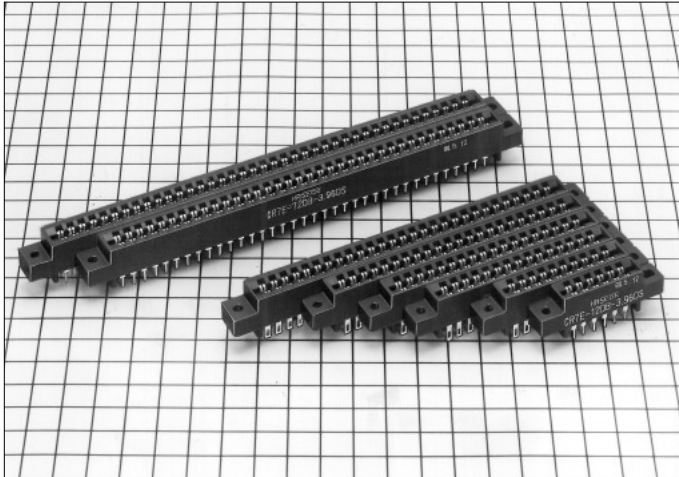

### Connection Type

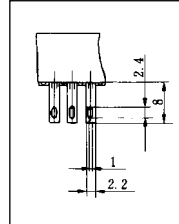

Eyelet

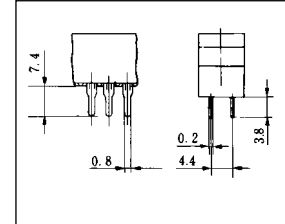

Through hole

### ■ Features

#### 1. Contact Type

Uses 2 steps of bellows type contact, where the contact pitch is 3.96mm or 4mm.

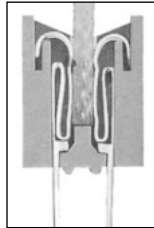

#### 2. Variation in number of contacts

12, 20, 28, 30, 36, 44, 56, 72 and 80 contacts are available.

#### 3. Connection Type

Eyelet and through hole types are available.

#### 4. Prevents mis-insertion in the board

Using the polarizing key prevents mis-insertion in the printed board.

### ■ Product Specifications

Rating	Current rating: 3A Voltage rating: 600V AC	Operating Temperature Range: -30 to +85°C (Note 1) Operating Humidity Range: 40 to 80%	Storage Temperature Range: -10 to +60°C (Note 2) Storage Humidity Range: 40 to 70% (Note 2)
--------	---	---	--

Item	Specification	Condition
1. Insulation Resistance	5000M ohms	500V DC
2. Withstanding Voltage	No flashover or insulation breakdown.	1800V AC/1 minute
3. Contact Resistance	15m ohms max.	100mA
4. Vibration	No electrical discontinuity of 10 $\mu$ s or more	Frequency: 10 to 55 Hz, single amplitude of 0.75 mm, 2 hours in each of the 3 directions.
5. Humidity (Steady state)	Insulation resistance: 1000M min.	96 hours at temperature of 40°C and humidity of 90% to 95%
6. Temperature Cycle	No damage, cracks, or parts looseness.	(-55°C : 30 minutes → 15 to 35°C: 5 minutes max. → 85°C : 30 minutes → 15 to 35°C: 5 minutes max.) 5 cycles
7. Durability (Mating/un-mating)	Contact resistance: 15m ohms max.	500 cycles
8. Resistance to Soldering heat	No deformation of components affecting performance.	Manual soldering: 300°C for 3 seconds

Note 1: Includes temperature rise caused by current flow.

Note 2: The term "storage" refers to products stored for long period of time prior to mounting and use. Operating Temperature Range and Humidity range covers non conducting condition of installed connectors in storage, shipment or during transportation.

## Material

Parts	Material	Finish		Remarks
Insulator	Polycarbonate	Blue		UL94V-0
Contact	Copper alloy	Contact area	Selective gold plated	————
		Lead area	Tin-lead plated	————

## Ordering Information

$\frac{\text{CR7}}{\text{①}}$    
  $\frac{\text{C}}{\text{②}} - \frac{\text{20}}{\text{③}}$    
 $\frac{\text{D}}{\text{④}}$    
 $\frac{\text{B}}{\text{⑤}} - \frac{\text{4}}{\text{⑥}}$    
 $\frac{\text{E}}{\text{⑦}}$

① Series Name	: CR7	④ Contact alignment	: D:Double side
② Mold type	: C : 4mm pitch mold	⑤ Contact Type	B : Selective gold plated
	E : 3.96mm pitch mold	⑥ Contact pitch	: 4mm or 3.96mm
③ Number of contacts	C : 20, 28, 36, 44, 56	⑦ Contact style	E : Eyelet
	E : 12, 20, 30, 36, 44, 56, 72, 80		DS : Through hole

## Contact Type

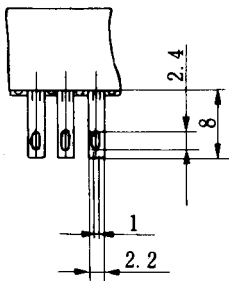

(1) Eyelet

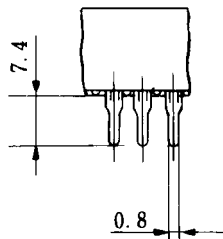

(2) Through hole

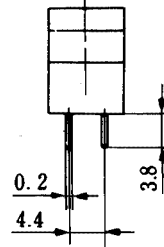

## ■3.96mm Pitch Type

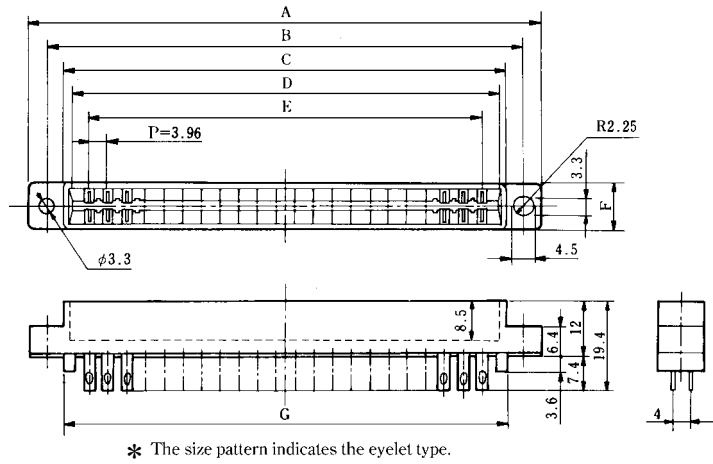

Unit: mm

Part Number	CL No.	Number of Contacts	A	B	C	D	E	F	G
CR7E-12DB-3.96E	507-0102-6	12	47	38.9	30.7	28	19.8	9	29.7
CR7E-12DB-3.96DS	507-0115-8								
CR7E-20DB-3.96E	507-0103-9	20	63	54.8	47.3	43.8	35.64	9	46.3
CR7E-20DB-3.96DS	507-0116-0								
CR7E-30DB-3.96E	507-0104-1	30	82.5	74.6	67.2	63.6	55.44	9	66.2
CR7E-30DB-3.96DS	507-0117-3								
CR7E-36DB-3.96E	507-0105-4	36	94.4	86.5	79	75.5	67.32	9	79
CR7E-36DB-3.96DS	507-0118-6								
CR7E-44DB-3.96E	507-0106-7	44	110.2	102.4	95	91.4	83.16	9	94
CR7E-44DB-3.96DS	507-0119-9								
CR7E-56DB-3.96E	507-0107-0	56	133.7	126	118.1	115	106.92	11.1	117.1
CR7E-56DB-3.96DS	507-0120-8								
CR7E-72DB-3.96E	507-0108-2	72	166	158	150	146.8	138.68	11.1	149
CR7E-72DB-3.96DS	507-0121-0								
CR7E-80DB-3.96E	507-0109-5	80	182	174	166	162.7	154.44	11.1	165
CR7E-80DB-3.96DS	507-0122-3								

## ■4mm Pitch Type

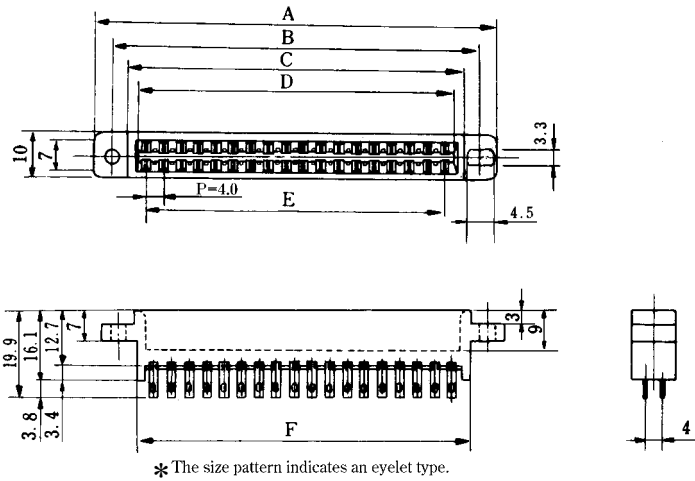

Unit: mm

Part Number	CL No.	Number of Contacts	A	B	C	D	E	F
CR7C-20DB-4E	507-0110-4	20	58	50	43	41	36	43
CR7C-20DB-4DS	507-0123-6							
CR7C-28DB-4E	507-0111-7	28	75	67	60	57	52	59
CR7C-28DB-4DS	507-0124-9							
CR7C-36DB-4E	507-0112-0	36	92	84	77	73	68	76
CR7C-36DB-4DS	507-0125-1							
CR7C-44DB-4E	507-0113-2	44	109	101	93	89	84	93
CR7C-44DB-4DS	507-0126-4							
CR7C-56DB-4E	507-0114-5	56	133	125	117	113.5	108	117
CR7C-56DB-4DS	507-0127-7							

## ◆PCB Dimensions

3.96 pitch

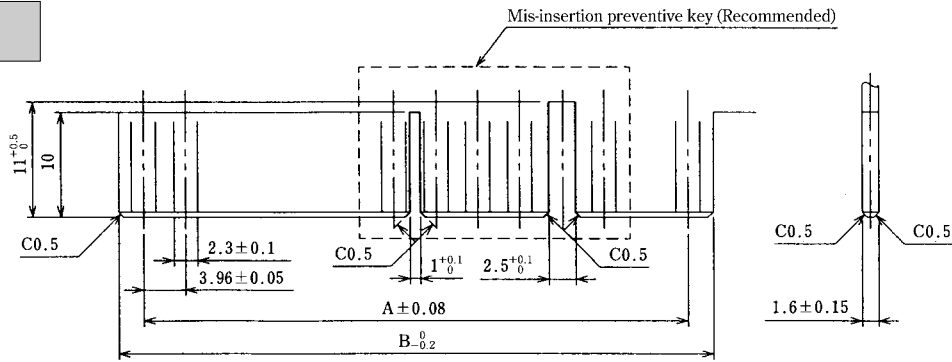

Number of Contacts	12	20	30	36	44	56	72	80
A	19.8	35.64	55.44	67.32	83.16	106.98	138.68	154.44
B	27.8	43.6	63.4	75.3	91.2	114.8	146.6	162.5

Note: Using the polarizing key prevents mis-insertion in the printed board.  
To use the polarizing key, insert the polarizing key so as to hit the mold bottom.

4mm pitch

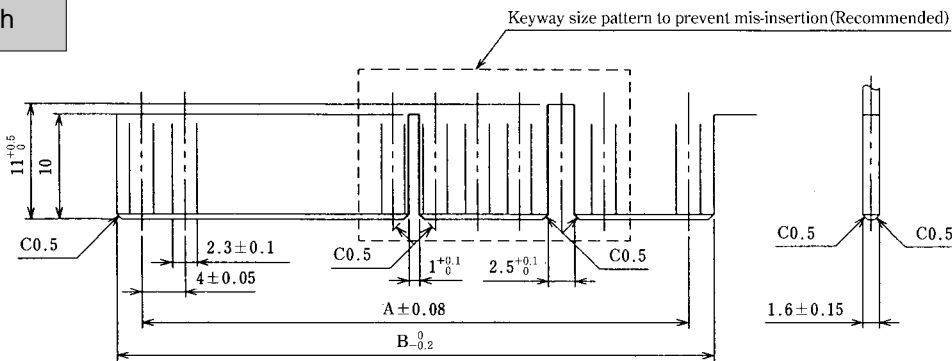

Number of Contacts	20	28	36	44	56
A	36	52	68	84	108
B	40.8	56.8	72.8	88.8	107.8

Note: Using the polarizing key prevents mis-insertion in the printed board.  
To use the polarizing key, insert the polarizing key so as to hit the mold bottom.

## ■Polarizing Key

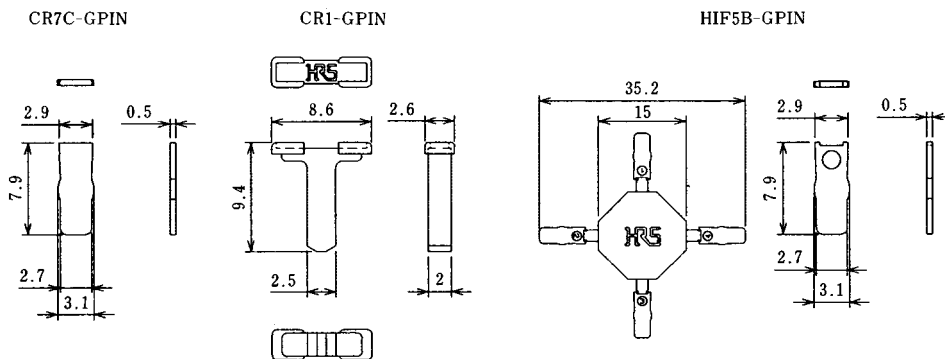

Part Number	CL No.	Material	Color
CR7C-GPIN	507-0055-8	Poly-acetal	White
CR1-GPIN	501-0030-9	ABS	Gray
HIF5B-GPIN	564-0052-4	PBT	Beige

## ◆PCB Cutouts

3.96 pitch

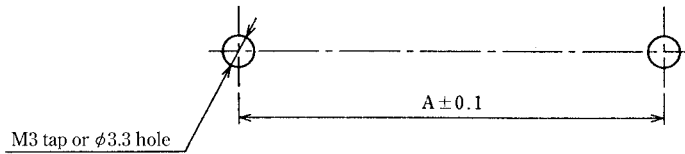

Number of Contacts	12	20	30	36	44	56	72	80
A	38.9	54.8	74.6	86.5	102.4	126	158	174

4mm pitch

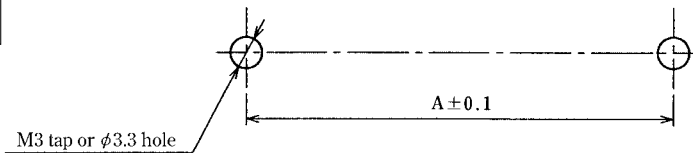

Number of Contacts	20	30	36	44	56
A	50	67	84	101	125

## ◆Contact No. Alignment List

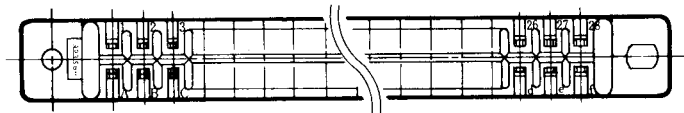

Note 1. To use alphabetic symbols, following 8 alphabetic characters are not used.

G, I, O, Q, g, i, o, q

Note 2. The above pattern is viewed from the contact (connection) side.