

CTP4550 is a high current inductor with the following data and features:

- **Core type:** 1.30" o.d., Iron Powder, perm 33.
 - **Power rating:** 3.13 watts for temp. rise 50°C.
 - **Typical applications:** Filter Inductors in Switch Mode Power Supplies.
- Three mounting styles are offered:**
- 1 Flying leads (1.00"), for vertical or horizontal mounting.
 - 2 4-pin header, for vertical mounting.
 - 3 Threaded center hole, flying leads (2.00").



MECHANICAL

Style 1

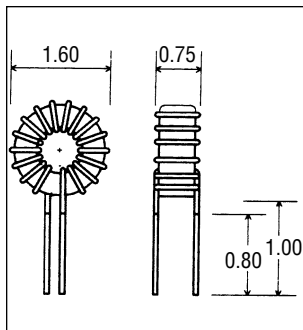

Style 2

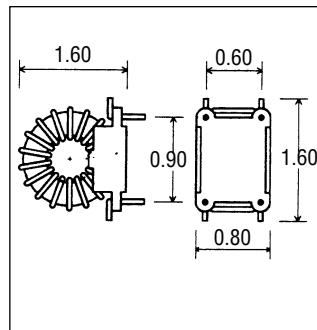

Style 3

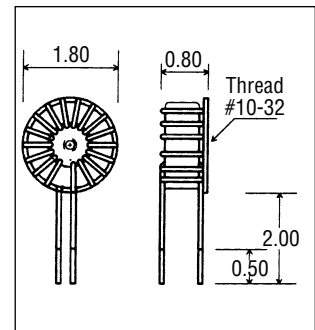

ELECTRICAL SPECIFICATION

Ordering Information: Substitute the style number for the asterisk (*). Example: CTP4550, Style 1, 56uH. Order: CTP4550 - 116

Part No. CTP4550 -	Ind. (uH)	DCR Ohms	Rated Current Amp. RMS	I (amp.) @ Lsat. 10%	I (amp.) @ Lsat. 25%	I (amp.) @ Lsat. 50%	Part No. CTP4550 -	Ind. (uH)	DCR Ohms	Rated Current Amp. RMS	I (amp.) @ Lsat. 10%	I (amp.) @ Lsat. 25%	I (amp.) @ Lsat. 50%
* 01	3.3	0.002	41.4	20.9	52.2	125.2	* 17	68	0.016	13.9	4.6	11.5	27.6
* 02	3.9	0.002	39.8	19.2	48.0	115.1	* 18	82	0.018	13.3	4.2	10.5	25.1
* 03	4.7	0.002	38.0	17.5	43.7	104.9	* 19	100	0.020	12.7	3.8	9.5	22.7
* 04	5.6	0.002	36.4	16.0	40.0	96.1	* 20	120	0.021	12.1	3.5	8.6	20.8
* 05	6.8	0.005	34.8	14.5	36.3	87.2	* 21	150	0.030	10.2	3.1	7.7	18.6
* 06	8.2	0.005	33.2	13.2	33.1	79.4	* 22	180	0.033	9.7	2.8	7.1	16.9
* 07	10	0.007	31.6	12.0	30.0	71.9	* 23	220	0.036	9.3	2.6	6.4	15.3
* 08	12	0.008	30.3	10.9	27.3	65.6	* 24	270	0.051	7.8	2.3	5.8	13.8
* 09	15	0.009	25.5	9.8	24.5	58.7	* 25	330	0.071	6.6	2.1	5.2	12.5
* 10	18	0.010	24.4	8.9	22.3	53.6	* 26	390	0.122	5.1	1.9	4.8	11.5
* 11	22	0.013	20.7	8.1	20.2	48.5	* 27	470	0.134	4.8	1.7	4.4	10.5
* 12	27	0.015	19.7	7.3	18.2	43.8	* 28	560	0.146	4.6	1.6	4.0	9.6
* 13	33	0.016	18.7	6.6	16.5	39.6							
* 14	39	0.018	18.0	6.1	15.2	36.4							
* 15	47	0.020	15.3	5.5	13.8	33.2							
* 16	56	0.021	14.6	5.1	12.7	30.4							

CTP4550