



512K x 32 Static RAM

Features

- **High speed**
— $t_{AA} = 8, 10, 12 \text{ ns}$
- **Low active power**
— 1080 mW (max.)
- **Operating voltages of $3.3 \pm 0.3V$**
- **2.0V data retention**
- **Automatic power-down when deselected**
- **TTL-compatible inputs and outputs**
- **Easy memory expansion with \overline{CE}_1 , \overline{CE}_2 , and \overline{CE}_3 features**

Functional Description

The CY7C1062AV33 is a high-performance CMOS Static RAM organized as 524,288 words by 32 bits.

Writing to the device is accomplished by enabling the chip (\overline{CE}_1 , \overline{CE}_2 and \overline{CE}_3 LOW) and forcing the Write Enable (WE) input LOW. If Byte Enable A (\overline{B}_A) is LOW, then data from I/O pins (I/O_0 through I/O_7), is written into the location specified on

the address pins (A_0 through A_{18}). If Byte Enable B (\overline{B}_B) is LOW, then data from I/O pins (I/O_8 through I/O_{15}) is written into the location specified on the address pins (A_0 through A_{18}). Likewise, \overline{B}_C and \overline{B}_D correspond with the I/O pins I/O_{16} to I/O_{23} and I/O_{24} to I/O_{31} , respectively.

Reading from the device is accomplished by enabling the chip (\overline{CE}_1 , \overline{CE}_2 , and \overline{CE}_3 LOW) while forcing the Output Enable (OE) LOW and Write Enable (WE) HIGH. If the first Byte Enable (\overline{B}_A) is LOW, then data from the memory location specified by the address pins will appear on I/O_0 to I/O_7 . If Byte Enable B (\overline{B}_B) is LOW, then data from memory will appear on I/O_8 to I/O_{15} . Similarly, \overline{B}_C and \overline{B}_D correspond to the third and fourth bytes. See the truth table at the back of this data sheet for a complete description of read and write modes.

The input/output pins (I/O_0 through I/O_{31}) are placed in a high-impedance state when the device is deselected (\overline{CE}_1 , \overline{CE}_2 or \overline{CE}_3 HIGH), the outputs are disabled (OE HIGH), the byte selects are disabled (\overline{B}_{A-D} HIGH), or during a write operation (\overline{CE}_1 , \overline{CE}_2 , and \overline{CE}_3 LOW, and WE LOW).

The CY7C1062AV33 is available in a 119-ball pitch ball grid array (PBGA) package.

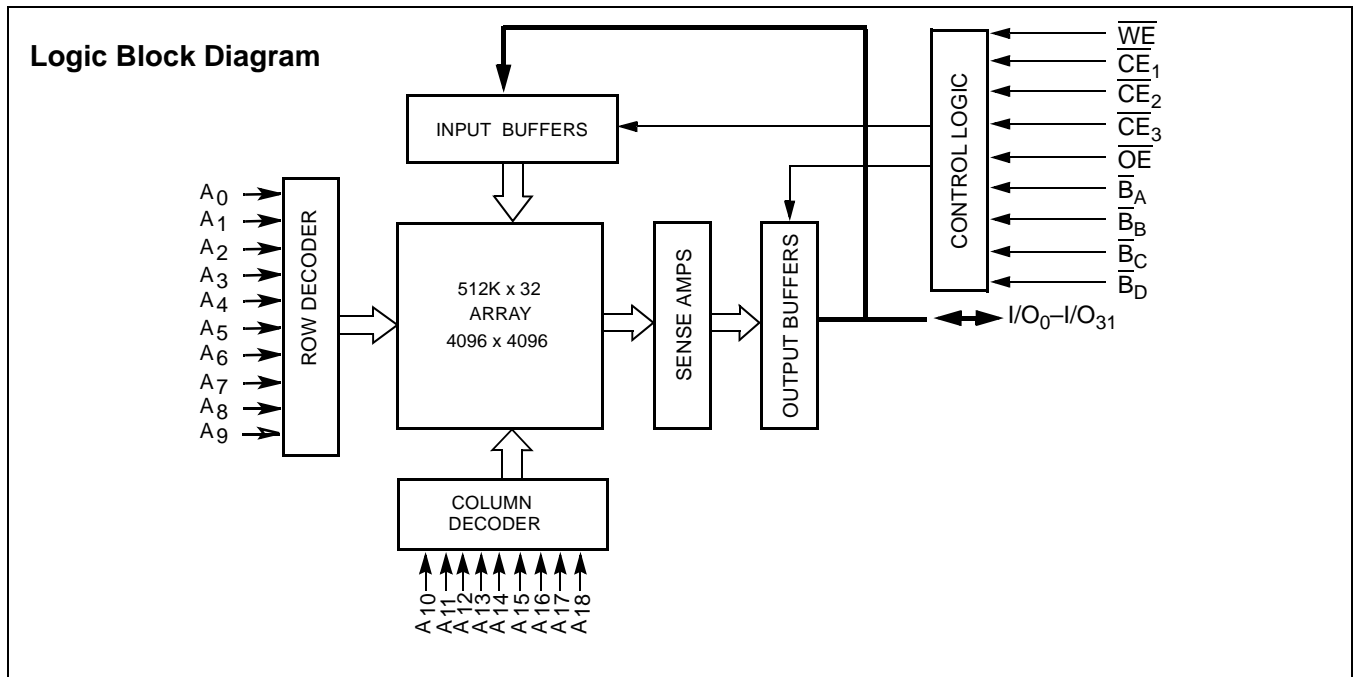

Selection Guide

		-8	-10	-12	Unit
Maximum Access Time		8	10	12	ns
Maximum Operating Current	Com'l	300	275	260	mA
	Ind'l	300	275	260	
Maximum CMOS Standby Current	Com'l/Ind'l	50	50	50	mA

Pin Configuration
119-ball PBGA

(Top View)

	1	2	3	4	5	6	7
A	I/O ₁₆	A	A	A	A	A	I/O ₀
B	I/O ₁₇	A	A	\overline{CE}_1	A	A	I/O ₁
C	I/O ₁₈	\overline{B}_c	\overline{CE}_2	NC	\overline{CE}_3	\overline{B}_a	I/O ₂
D	I/O ₁₉	V _{DD}	V _{SS}	V _{SS}	V _{SS}	V _{DD}	I/O ₃
E	I/O ₂₀	V _{SS}	V _{DD}	V _{SS}	V _{DD}	V _{SS}	I/O ₄
F	I/O ₂₁	V _{DD}	V _{SS}	V _{SS}	V _{SS}	V _{DD}	I/O ₅
G	I/O ₂₂	V _{SS}	V _{DD}	V _{SS}	V _{DD}	V _{SS}	I/O ₆
H	I/O ₂₃	V _{DD}	V _{SS}	V _{SS}	V _{SS}	V _{DD}	I/O ₇
J	NC	V _{SS}	V _{DD}	V _{SS}	V _{DD}	V _{SS}	DNU
K	I/O ₂₄	V _{DD}	V _{SS}	V _{SS}	V _{SS}	V _{DD}	I/O ₈
L	I/O ₂₅	V _{SS}	V _{DD}	V _{SS}	V _{DD}	V _{SS}	I/O ₉
M	I/O ₂₆	V _{DD}	V _{SS}	V _{SS}	V _{SS}	V _{DD}	I/O ₁₀
N	I/O ₂₇	V _{SS}	V _{DD}	V _{SS}	V _{DD}	V _{SS}	I/O ₁₁
P	I/O ₂₈	V _{DD}	V _{SS}	V _{SS}	V _{SS}	V _{DD}	I/O ₁₂
R	I/O ₂₉	A	\overline{B}_d	NC	\overline{B}_b	A	I/O ₁₃
T	I/O ₃₀	A	A	\overline{WE}	A	A	I/O ₁₄
U	I/O ₃₁	A	A	\overline{OE}	A	A	I/O ₁₅

Maximum Ratings

(Above which the useful life may be impaired. For user guidelines, not tested.)

Storage Temperature -65°C to +150°C
 Ambient Temperature with
 Power Applied -55°C to +125°C
 Supply Voltage on V_{CC} to Relative GND^[1] -0.5V to +4.6V
 DC Voltage Applied to Outputs
 in High-Z State^[1] -0.5V to V_{CC} + 0.5V

DC Input Voltage^[1] -0.5V to V_{CC} + 0.5V
 Current into Outputs (LOW) 20 mA

Operating Range

Range	Ambient Temperature	V _{CC}
Commercial	0°C to +70°C	3.3V ± 0.3V
Industrial	-40°C to +85°C	

DC Electrical Characteristics Over the Operating Range

Parameter	Description	Test Conditions	-8		-10		-12		Unit
			Min.	Max.	Min.	Max.	Min.	Max.	
V _{OH}	Output HIGH Voltage	V _{CC} = Min., I _{OH} = -4.0 mA	2.4		2.4		2.4		V
V _{OL}	Output LOW Voltage	V _{CC} = Min., I _{OL} = 8.0 mA		0.4		0.4		0.4	V
V _{IH}	Input HIGH Voltage		2.0	V _{CC} + 0.3	2.0	V _{CC} + 0.3	2.0	V _{CC} + 0.3	V
V _{IL}	Input LOW Voltage ^[1]		-0.3	0.8	-0.3	0.8	-0.3	0.8	V
I _{IX}	Input Load Current	GND ≤ V _I ≤ V _{CC}	-1	+1	-1	+1	-1	+1	μA
I _{OZ}	Output Leakage Current	GND ≤ V _{OUT} ≤ V _{CC} , Output Disabled	-1	+1	-1	+1	-1	+1	μA
I _{CC}	V _{CC} Operating Supply Current	V _{CC} = Max., f = f _{MAX} = 1/t _{RC}	Com'l	300		275		260	mA
			Ind'l	300		275		260	mA
I _{SB1}	Automatic CE Power-down Current —TTL Inputs	Max. V _{CC} , CE ≥ V _{IH} V _{IN} ≥ V _{IH} or V _{IN} ≤ V _{IL} , f = f _{MAX}		70		70		70	mA
I _{SB2}	Automatic CE Power-down Current —CMOS Inputs	Max. V _{CC} , CE ≥ V _{CC} - 0.3V, V _{IN} ≥ V _{CC} - 0.3V, or V _{IN} ≤ 0.3V, f = 0	Com'l/Ind'l	50		50		50	mA

Capacitance^[2]

Parameter	Description	Test Conditions	Max.	Unit
C _{IN}	Input Capacitance	T _A = 25°C, f = 1 MHz, V _{CC} = 3.3V	8	pF
C _{OUT}	I/O Capacitance		10	pF

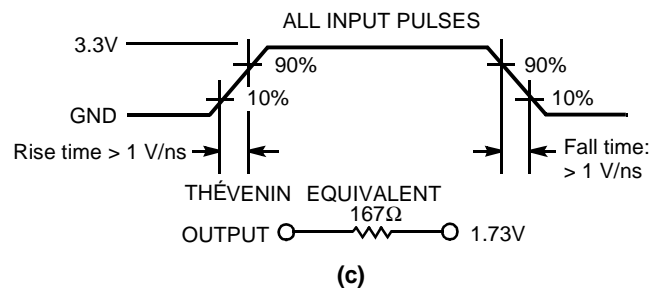
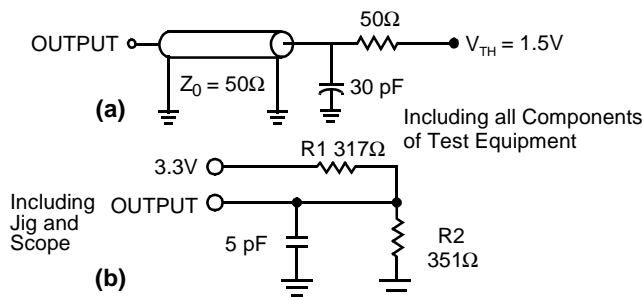
AC Test Loads and Waveforms^[3]

Notes:

- V_{IL} (min.) = -2.0V for pulse durations of less than 20 ns.
- Tested initially and after any design or process changes that may affect these parameters.
- Valid SRAM operation does not occur until the power supplies have reached the minimum operating V_{DD} (3.0V). As soon as 1ms (T_{power}) after reaching the minimum operating V_{DD}, normal SRAM operation can begin including reduction in V_{DD} to the data retention (V_{CCDR}, 2.0V) voltage.

AC Switching Characteristics Over the Operating Range^[4]

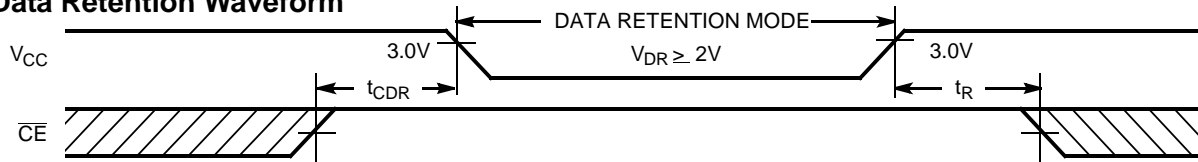
Parameter	Description	-8		-10		-12		Unit
		Min.	Max.	Min.	Max.	Min.	Max.	
Read Cycle								
t_{power}	V_{CC} (typical) to the first access ^[5]	1		1		1		ms
t_{RC}	Read Cycle Time	8		10		12		ns
t_{AA}	Address to Data Valid		8		10		12	ns
t_{OHA}	Data Hold from Address Change	3		3		3		ns
t_{ACE}	\overline{CE}_1 , \overline{CE}_2 , or \overline{CE}_3 LOW to Data Valid		8		10		12	ns
t_{DOE}	\overline{OE} LOW to Data Valid		5		5		6	ns
t_{LZOE}	\overline{OE} LOW to Low-Z ^[6]	1		1		1		ns
t_{HZOE}	\overline{OE} HIGH to High-Z ^[6]		5		5		6	ns
t_{LZCE}	\overline{CE}_1 , \overline{CE}_2 , or \overline{CE}_3 LOW to Low-Z ^[6]	3		3		3		ns
t_{HZCE}	\overline{CE}_1 , \overline{CE}_2 , or \overline{CE}_3 HIGH to High-Z ^[6]		5		5		6	ns
t_{PU}	\overline{CE}_1 , \overline{CE}_2 , or \overline{CE}_3 LOW to Power-up ^[7]	0		0		0		ns
t_{PD}	\overline{CE}_1 , \overline{CE}_2 , or \overline{CE}_3 HIGH to Power-down ^[7]		8		10		12	ns
t_{DBE}	Byte Enable to Data Valid		5		5		6	ns
t_{LZBE}	Byte Enable to Low-Z ^[6]	1		1		1		ns
t_{HZBE}	Byte Disable to High-Z ^[6]		5		5		6	ns
Write Cycle^[8, 9]								
t_{WC}	Write Cycle Time	8		10		12		ns
t_{SCE}	\overline{CE}_1 , \overline{CE}_2 , or \overline{CE}_3 LOW to Write End	6		7		8		ns
t_{AW}	Address Set-up to Write End	6		7		8		ns
t_{HA}	Address Hold from Write End	0		0		0		ns
t_{SA}	Address Set-up to Write Start	0		0		0		ns
t_{PWE}	\overline{WE} Pulse Width	6		7		8		ns
t_{SD}	Data Set-up to Write End	5		5.5		6		ns
t_{HD}	Data Hold from Write End	0		0		0		ns
t_{LZWE}	\overline{WE} HIGH to Low-Z ^[6]	3		3		3		ns
t_{HZWE}	\overline{WE} LOW to High-Z ^[6]		5		5		6	ns
t_{BW}	Byte Enable to End of Write	6		7		8		ns

Data Retention Waveform

Notes:

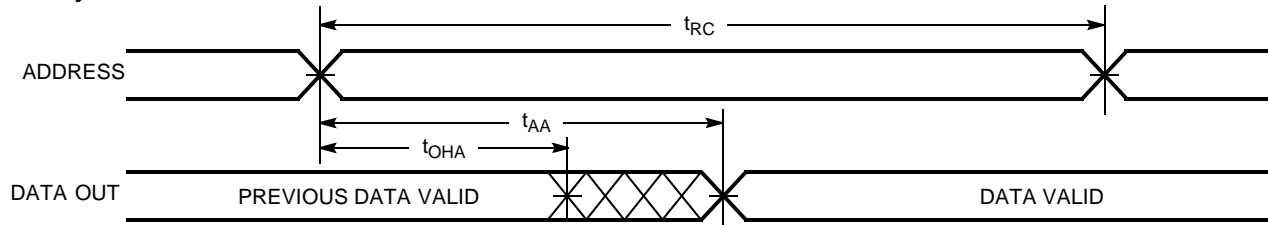
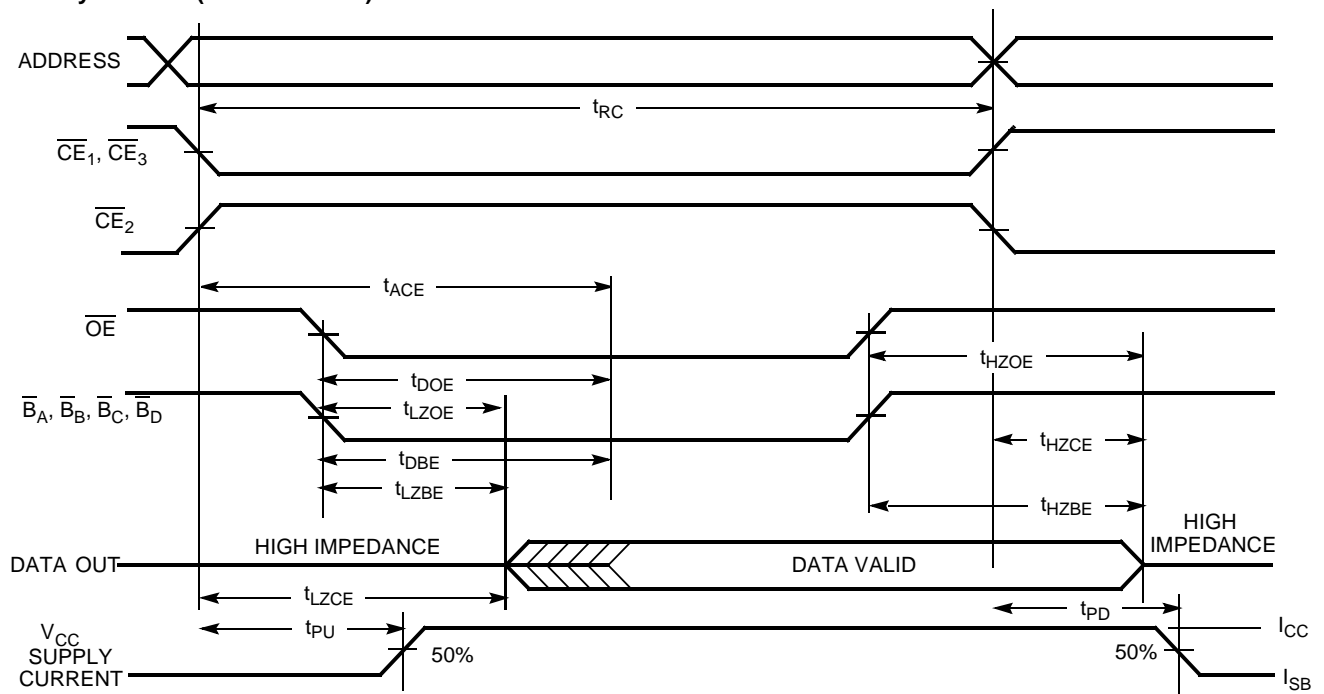
- Test conditions assume signal transition time of 3 ns or less, timing reference levels of 1.5V, input pulse levels of 0 to 3.0V, and output loading of the specified I_{OL}/I_{OH} and transmission line loads. Test conditions for the read cycle use output loading as shown in (a) of AC Test Loads, unless specified otherwise.
- This part has a voltage regulator that steps down the voltage from 3V to 2V internally. t_{power} time has to be provided initially before a read/write operation is started.
- t_{HZOE} , t_{HZCE} , t_{HZWE} , t_{HZBE} , and t_{LZOE} , t_{LZCE} , t_{LZWE} , and t_{LZBE} are specified with a load capacitance of 5 pF as in (b) of AC Test Loads. Transition is measured ± 200 mV from steady-state voltage.
- These parameters are guaranteed by design and are not tested.
- The internal write time of the memory is defined by the overlap of \overline{CE}_1 LOW, \overline{CE}_2 HIGH, \overline{CE}_3 LOW, and \overline{WE} LOW. The chip enables must be active and \overline{WE} must be LOW to initiate a write, and the transition of any of these signals can terminate the write. The input data set-up and hold timing should be referenced to the leading edge of the signal that terminates the write.
- The minimum write cycle time for Write Cycle No. 3 (\overline{WE} controlled, \overline{OE} LOW) is the sum of t_{HZWE} and t_{SD} .

Switching Waveforms
Read Cycle No. 1 [10, 11]

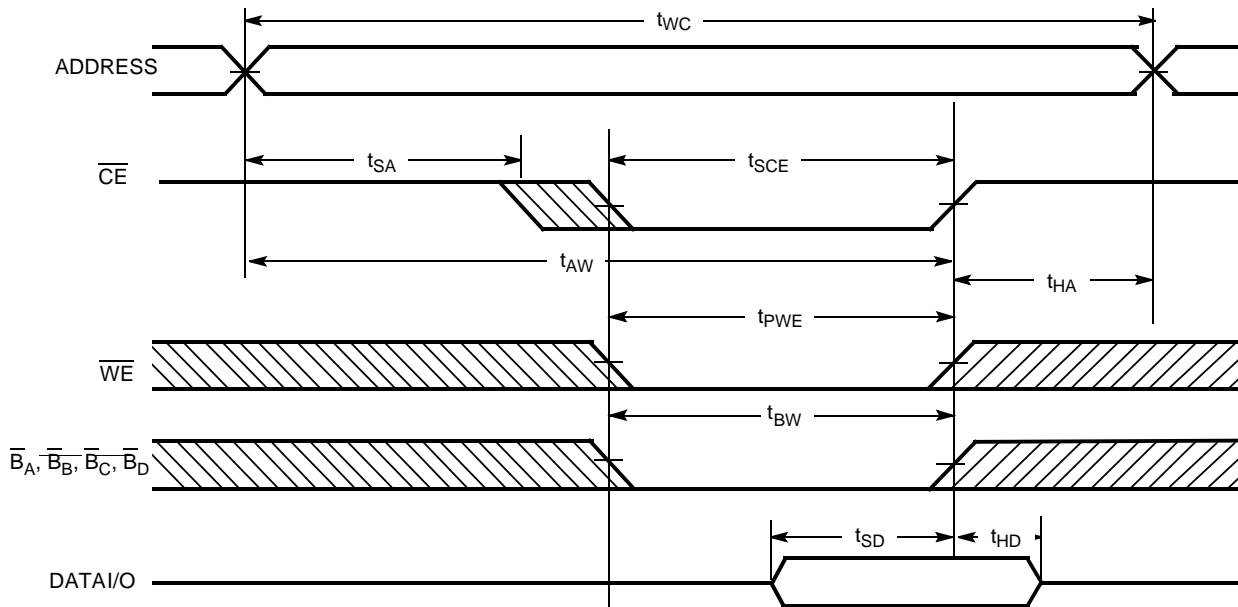
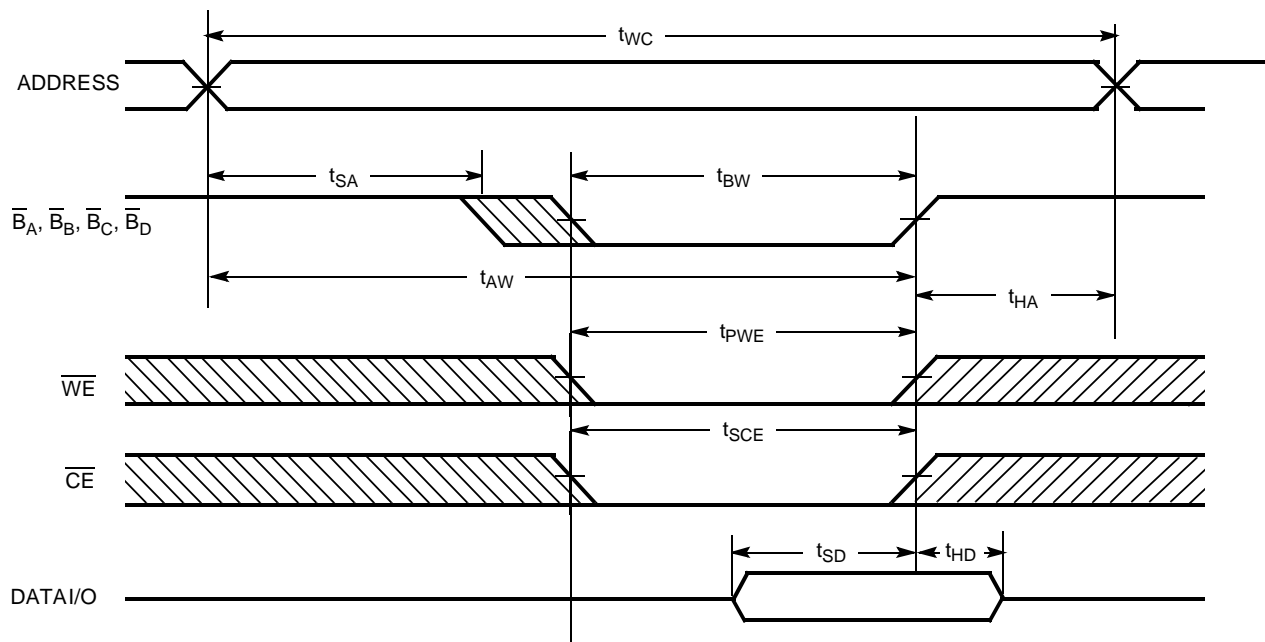
Read Cycle No. 2 (OE Controlled) [11, 12]

Notes:

10. Device is continuously selected. \overline{OE} , \overline{CE} , \overline{BA} , \overline{BB} , \overline{BC} , \overline{BD} = V_{IL} .
11. \overline{WE} is HIGH for read cycle.
12. Address valid prior to or coincident with \overline{CE} transition LOW.

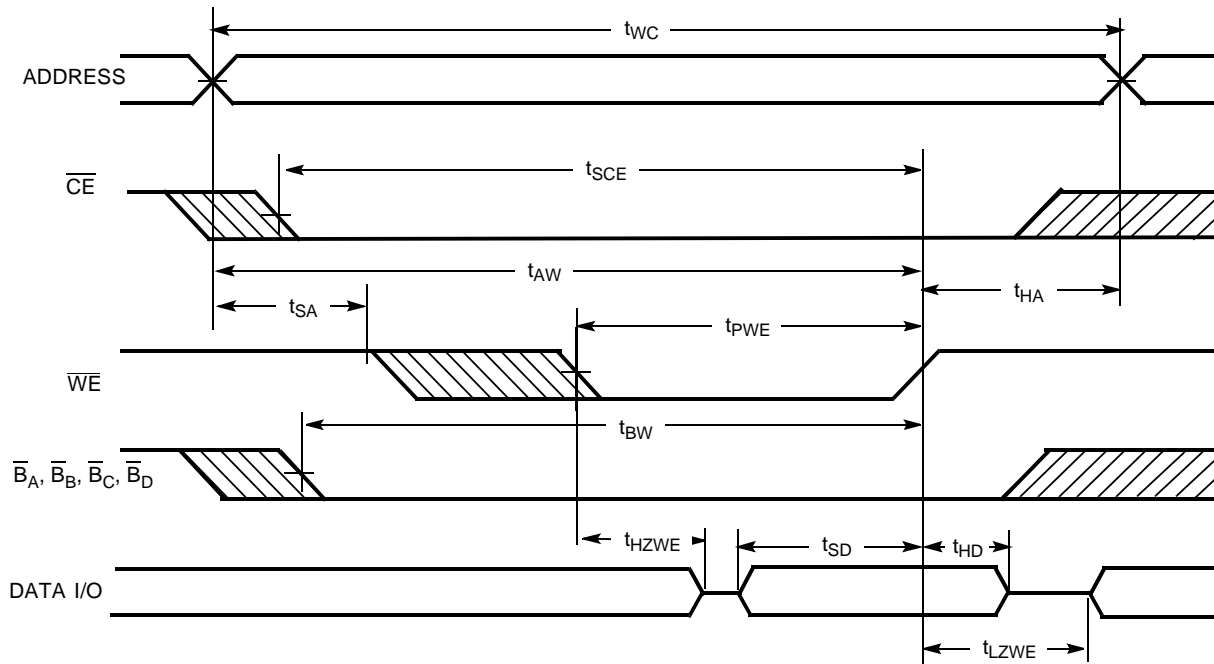
Switching Waveforms (continued)
Write Cycle No. 1 (\overline{CE} Controlled)^[13, 14, 15]

Write Cycle No. 2 (\overline{BLE} or \overline{BHE} Controlled)^[13, 14, 15]

Notes:

13. \overline{CE} indicates a combination of all three chip enables. When ACTIVE LOW, \overline{CE} indicates the \overline{CE}_1 , \overline{CE}_2 and \overline{CE}_3 are LOW.
14. Data I/O is high-impedance if \overline{OE} or $\overline{B_A}, \overline{B_B}, \overline{B_C}, \overline{B_D} = V_{IH}$.
15. If \overline{CE} goes HIGH simultaneously with \overline{WE} going HIGH, the output remains in a high-impedance state.

Switching Waveforms (continued)
Write Cycle No. 3 (\overline{WE} Controlled, \overline{OE} LOW)

Truth Table

\overline{CE}_1	\overline{CE}_2	\overline{CE}_3	\overline{OE}	\overline{WE}	\overline{B}_A	\overline{B}_B	\overline{B}_C	\overline{B}_D	I/O ₀ ⁻ I/O ₇	I/O ₈ ⁻ I/O ₁₅	I/O ₁₆ ⁻ I/O ₂₃	I/O ₂₄ ⁻ I/O ₃₁	Mode	Power
H	L	H	X	X	X	X	X	X	High-Z	High-Z	High-Z	High-Z	Power Down	(I _{SB})
L	H	L	X	X	X	X	X	X	High-Z	High-Z	High-Z	High-Z	Power Down	(I _{SB})
L	L	L	L	H	L	L	L	L	Data Out	Data Out	Data Out	Data Out	Read All Bits	(I _{CC})
L	L	L	L	H	L	H	H	H	Data Out	High-Z	High-Z	High-Z	Read Byte A Bits Only	(I _{CC})
L	L	L	L	H	H	L	H	H	High-Z	Data Out	High-Z	High-Z	Read Byte B Bits Only	(I _{CC})
L	L	L	L	H	H	H	L	H	High-Z	High-Z	Data Out	High-Z	Read Byte C Bits Only	(I _{CC})
L	L	L	L	H	H	H	H	L	High-Z	High-Z	High-Z	Data Out	Read Byte D Bits Only	(I _{CC})
L	L	L	X	L	L	L	L	L	Data In	Data In	Data In	Data In	Write All Bits	(I _{CC})
L	L	L	X	L	L	H	H	H	Data In	High-Z	High-Z	High-Z	Write Byte A Bits Only	(I _{CC})
L	L	L	X	L	H	L	H	H	High-Z	Data In	High-Z	High-Z	Write Byte B Bits Only	(I _{CC})
L	L	L	X	L	H	H	L	H	High-Z	High-Z	Data In	High-Z	Write Byte C Bits Only	(I _{CC})
L	L	L	X	L	H	H	H	L	High-Z	High-Z	High-Z	Data In	Write Byte D Bits Only	(I _{CC})
L	L	L	H	H	X	X	X	X	High-Z	High-Z	High-Z	High-Z	Selected, Outputs Disabled	(I _{CC})

Ordering Information

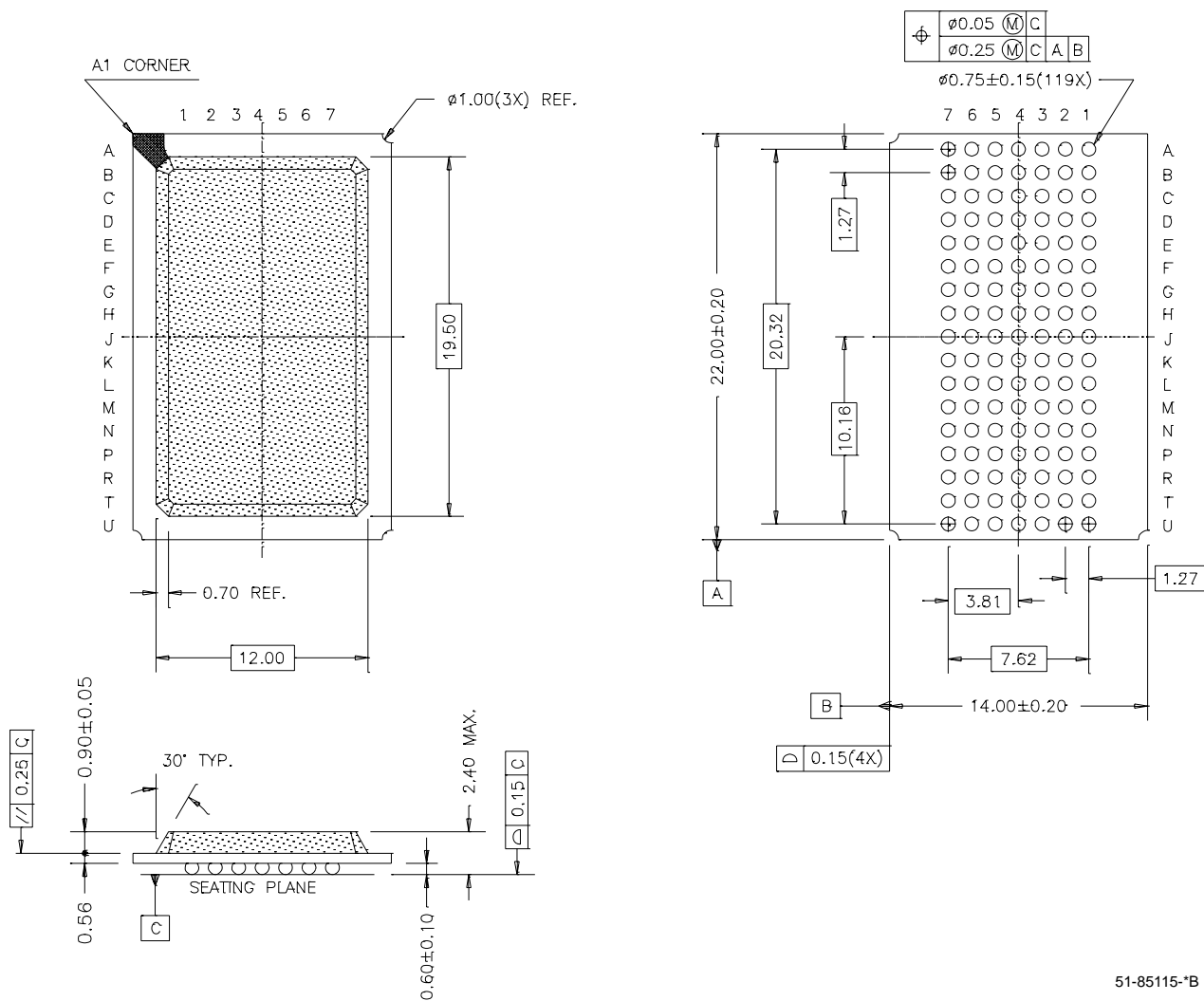
Speed (ns)	Ordering Code	Package Name	Package Type	Operating Range
8	CY7C1062AV33-8BGC	BG119	14 x 22 mm 119-ball PBGA	Commercial
	CY7C1062AV33-8BGI			Industrial
10	CY7C1062AV33-10BGC			Commercial
	CY7C1062AV33-10BGI			Industrial
12	CY7C1062AV33-12BGC			Commercial
	CY7C1062AV33-12BGI			Industrial

Package Diagram
119-ball PBGA (14 x 22 x 2.4 mm) BG119

51-85115-B

All product and company names mentioned in this document may be the trademarks of their respective holders.

Document History Page

Document Title: CY7C1062AV33 512K x 32 Static RAM				
Document Number: 38-05137				
REV.	ECN NO.	Issue Date	Orig. of Change	Description of Change
**	109752	02/27/02	HGK	New Data Sheet
*A	117059	09/19/02	DFP	Removed 15-ns bin and added 8-ns bin. Changed CE ₂ TO CE ₂ . Changed C _{IN} – input capacitance – from 6 pF to 8 pF. Changed C _{OUT} – output capacitance – from 8 pF to 10 pF.
*B	119389	10/07/02	DFP	Updated I _{CC} , T _{sd} , and T _{doe} parameters. Removed note 7 (I _Z /h _Z comment).
*C	120384	11/13/02	DFP	Final Data Sheet. Removed note 2. Added note 3 to “AC Test Loads and Waveforms” and note 7 to t _{pu} and t _{pd} .
*D	124440	2/25/03	MEG	Changed ISB1 from 100 mA to 70 mA