

SILICON PLANAR ZENER DIODES

CZMA3V9-47V

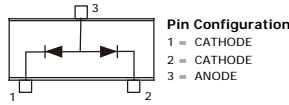
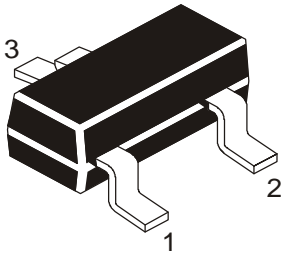

SOT-23
Formed SMD Package
 For Lead Free Parts, Device Part #
 will be Prefixed with "T"

Dual Zener Diodes, Common Anode

ABSOLUTE MAXIMUM RATINGS per diode (T_a=25°C unless specified otherwise)

DESCRIPTION	SYMBOL	VALUE	UNIT
Working Voltage Range	V _Z	3V9 to 39	V
Working Voltage Tolerance		± 5	%
Repetitive Peak Forward Current	I _{FRM}	250	mA
Repetitive Peak Working Current	I _{ZRM}	250	mA
Power Dissipation upto T _a =25°C	*P _{tot}	300	mW
Power Dissipation upto T _a =25°C	**P _{tot}	250	mW
Storage Temperature	T _j	150	°C
Junction Temperature	T _{stg}	- 55 to +150	°C
**Thermal Resistance			
From Junction to Ambient	R _{th(j-a)}	420	K/W

* Device mounted on a ceramic alumna

** Device mounted on an FR5 printed circuit board

ELECTRICAL CHARACTERISTICS per diode (T_a=25°C V_F < 0.9V max, I_F=10mA)

Device	Working Voltage		Differential Resistance		Reverse Current		Temperature Coefficient			Differential Resistance		Marking
	***V _Z (V) at I _{Z test} =5mA		r _{diff} (W) at I _{Z test} =5mA		I _R at	V _R	S _Z (mV/K) at I _{Z test} =5mA			r _{diff} (W) at I _{Z test} =5mA		
	min	max	typ	max	mA	V	min	typ	max	typ	max	
CZMA 3.9	3.70	4.10	85	90	3.0	1	-3.5	-2.5	0	400	600	D3.9
CZMA 4.3	4.00	4.60	80	90	3.0	1	-3.5	-2.5	0	410	600	D4.3
CZMA 4.7	4.40	5.00	50	80	3.0	2	-3.5	-1.4	0.2	425	500	D4.7
CZMA 5.1	4.80	5.40	40	60	2.0	2	-2.7	-0.8	1.2	400	480	D5.1
CZMA 5.6	5.20	6.00	15	40	1.0	2	-2.0	-1.2	2.5	80	400	D5.6
CZMA 6.2	5.80	6.60	6	10	3.0	4	0.4	2.3	3.7	40	150	D6.2
CZMA 6.8	6.40	7.20	6	15	2.0	4	1.2	3.0	4.5	30	80	D6.8
CZMA 7.5	7.00	7.90	6	15	1.0	5	2.5	4.0	5.3	30	80	D7.5
CZMA 8.2	7.70	8.70	6	15	0.7	5	3.2	4.6	6.2	40	80	D8.2
CZMA 9.1	8.50	9.60	6	15	0.5	6	3.8	5.5	7.0	40	100	D9.1
CZMA 10	9.40	10.60	8	20	0.2	7	4.5	6.4	8.0	50	150	D10

CZMA3.9_47VRev_1 071005E

***Pulse test 20ms ≤ t_p ≤ 50ms

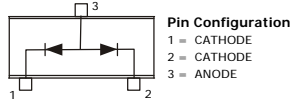
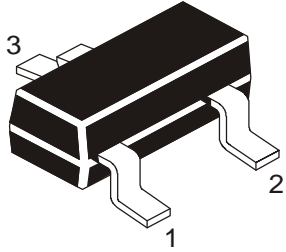

SOT-23
Formed SMD Package
 For Lead Free Parts, Device Part #
 will be Prefixed with "T"

ELECTRICAL CHARACTERISTICS per diode ($T_a=25^\circ\text{C}$ $V_F < 0.9\text{V}$ max, $I_F=10\text{mA}$)

Device	Working Voltage		Differential Resistance		Reverse Current		Temperature Coefficient			Differential Resistance		Marking
	*** V_Z (V) at I_Z test=5mA		r_{diff} (W) at I_Z test=5mA		I_R at	V_R	S_Z (mV/K) at I_Z test=5mA			r_{diff} (W) at I_Z test=1mA		
	min	max	typ	max	mA	V	min	typ	max	typ	max	
CZMA 11	10.40	11.60	10	20	0.1	8.0	5.4	7.4	9.0	50	150	D11
CZMA 12	11.40	12.70	10	25	0.1	8.0	6.0	8.4	10	50	150	D12
CZMA 13	12.40	14.10	10	30	0.1	8.0	7.0	9.4	11	50	170	D13
CZMA 15	13.80	15.60	10	30	0.05	10.5	9.2	11.4	13	50	200	D15
CZMA 16	15.30	17.10	10	40	0.05	11.2	10.4	12.4	14	50	200	D16
CZMA 18	16.80	19.10	10	45	0.05	12.6	12.4	14.4	16	50	225	D18
CZMA 20	18.80	21.20	15	55	0.05	14.0	14.4	16.4	18	60	225	D20
CZMA 22	20.80	23.30	20	55	0.05	15.4	16.4	18.4	20	60	250	D22
CZMA 24	22.80	25.60	25	70	0.05	16.8	18.4	20.4	22	60	250	D24
	at I_Z test=2mA		at I_Z test=2mA				at I_Z test=2mA			at I_Z test=0.5mA		
CZMA 27	25.10	28.90	25	80	0.05	18.9	21.4	23.4	25.3	65	300	D27
CZMA 30	28.00	32.00	30	80	0.05	21.0	24.4	26.6	29.4	70	300	D30
CZMA 33	31.00	35.00	35	80	0.05	23.1	27.4	29.7	33.4	75	325	D33
CZMA 36	34.00	38.00	35	90	0.05	25.2	30.4	33.0	37.4	80	350	D36
CZMA 39	37.00	41.00	40	130	0.05	27.3	33.4	36.4	41.2	80	350	D39
CZMA 43	40.00	46.00	45	150	0.05	30.1	37.6	41.2	46.6	85	375	D43
CZMA 47	44.00	50.00	50	170	0.05	32.9	42.0	46.1	51.8	85	375	D47

CZMA3.9_47VRev_1 071005E

***Pulse test $20\text{ms} \leq t_p \leq 50\text{ms}$

SOT-23 Formed SMD Package

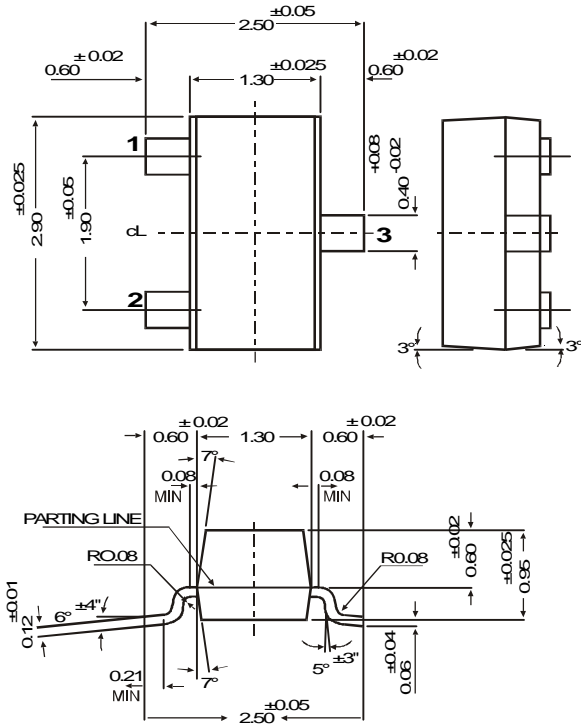

SOT-23 Package Reel Information
 Reel specification for W" Packing (13" reel)

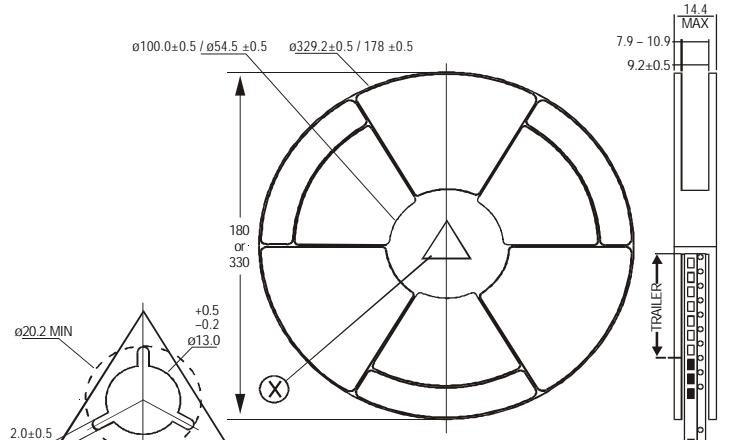

- All dimensions in mm
 330 / 180 mm – Antistatic Coated Plastic Reel
- | | 8mm Tape Size of Reel | 8mm Tape Size of Reel |
|----------------|----------------------------|--------------------------|
| No. of Devices | 330 mm (13")
10,000 Pcs | 180 mm (7")
3,000 Pcs |
- NOTES:
- The bandolier of 330 mm reel contains at least 10,000 devices.
 - The bandolier of 180 mm reel contains at least 3,000 devices.
 - No more than 0.5% missing devices / reel. 50 empty compartments for 330 mm reel. 15 empty compartments for 180 mm reel.
 - Three consecutive empty places might be found provided this gap is followed by 6 consecutive devices.
 - The carrier tape (leader) starts with at least 75 empty positions (equivalent to 330 mm). In order to fix the carrier tape a self adhesive tape of 20 to 50 mm is applied. At the end of the bandolier at least 40 empty positions (equivalent to 160 mm) are there.

Tape Specification for SOT-23 Surface Mount Device

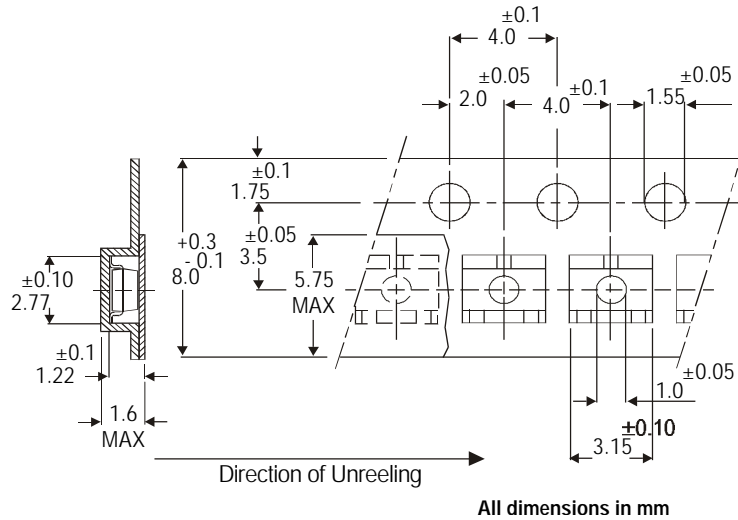

Packing Detail

PACKAGE	STANDARD PACK		INNER CARTON BOX		OUTER CARTON BOX		
	Details	Net Weight/Qty	Size	Qty	Size	Qty	Gr/Wt
SOT-23 T&R	3K/feol	136 gm/3K pcs	3' x 7.5" x 7.5"	12 K	17" x 15" x 13.5"	192 K	12 kgs
	10K/feol	415 gm/10K pcs	9' x 9' x 9"	51 K	19" x 19" x 19"	408 K	28 kgs
			13" x 13" x 0.5"	10 K	17" x 15" x 13.5"	300 K	16 kgs

SOT-23
Formed SMD Package
For Lead Free Parts, Device Part #
will be Prefixed with "T"

Disclaimer

The product information and the selection guides facilitate selection of the CDIL's Discrete Semiconductor Device(s) best suited for application in your product(s) as per your requirement. It is recommended that you completely review our Data Sheet(s) so as to confirm that the Device(s) meet functionality parameters for your application. The information furnished in the Data Sheet and on the CDIL Web Site/CD are believed to be accurate and reliable. CDIL however, does not assume responsibility for inaccuracies or incomplete information. Furthermore, CDIL does not assume liability whatsoever, arising out of the application or use of any CDIL product; neither does it convey any license under its patent rights nor rights of others. These products are not designed for use in life saving/support appliances or systems. CDIL customers selling these products (either as individual Discrete Semiconductor Devices or incorporated in their end products), in any life saving/support appliances or systems or applications do so at their own risk and CDIL will not be responsible for any damages resulting from such sale(s).

CDIL strives for continuous improvement and reserves the right to change the specifications of its products without prior notice.



CDIL is a registered Trademark of
Continental Device India Limited

C-120 Naraina Industrial Area, New Delhi 110 028, India.

Telephone + 91-11-2579 6150, 5141 1112 Fax + 91-11-2579 5290, 5141 1119

email@cdil.com

www.cdilsemi.com