

## SILICON PLANAR ZENER DIODES

## CZMK3V3-39V

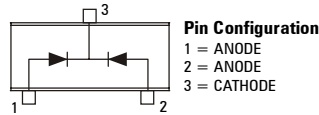
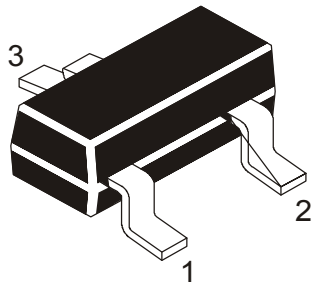

### SOT-23 Formed SMD Package

### Dual Zener Diodes, Common Cathode

#### ABSOLUTE MAXIMUM RATINGS Per Diode ( $T_a=25^\circ\text{C}$ Unless Specified Otherwise)

DESCRIPTION	SYMBOL	VALUE	UNIT
Working Voltage Range	$V_Z$	3V3 to 39	V
Working Voltage Tolerance		+/-5	%
Repetitive Peak Forward Current	$I_{FRM}$	250	mA
Repetitive Peak Working Current	$I_{ZRM}$	250	mA
Power Dissipation upto $T_{amb}=25^\circ\text{C}$	$P_{tot}^*$	300	mW
Power Dissipation upto $T_{amb}=25^\circ\text{C}$	$P_{tot}^{**}$	250	mW
Storage Temperature	$T_j$	150	$^\circ\text{C}$
Junction Temperature	$T_{stg}$	- 55 to +150	$^\circ\text{C}$

#### Thermal Resistance

From Junction to Ambient	$R_{th(j-a)}$	430	K/W
From Junction to Ambient	$R_{th(j-a)}$	500	K/W

\* Device mounted on a ceramic alumina

\*\* Device mounted on an FR5 printed circuit board

#### ELECTRICAL CHARACTERISTICS Per Diode ( $T_a=25^\circ\text{C}$ $V_F < 0.9\text{V max}$ , $I_F=10\text{mA}$ )

Device #	Working Voltage		Differential Resistance		Reverse Current		Temperature Coefficient			Differential Resistance		Marking
	$V_Z(\text{V})^{***}$ @ $I_{Ztest}=5\text{mA}$		$r_{diff}(\Omega)$ @ $I_{Ztest}=5\text{mA}$		$I_R$ $\mu\text{A}$ $\text{V}$		$S_Z(\text{mV/K})$ @ $I_{Ztest}=5\text{mA}$			$r_{diff}(\Omega)$ @ $I_{Ztest}=1\text{mA}$		
	min	max	typ	max			min	typ	max	typ	max	
CZMK 3.3	3.10	3.50	85	95	5.0	1	-3.5	-2.4	0	350	600	ZF
CZMK 3.6	3.40	3.80	85	90	5.0	1	-3.5	-2.4	0	375	600	ZG
CZMK 3.9	3.70	4.10	85	90	3.0	1	-3.5	-2.5	0	400	600	ZH
CZMK 4.3	4.00	4.60	80	90	3.0	1	-3.5	-2.5	0	410	600	ZJ
CZMK 4.7	4.40	5.00	50	80	3.0	2	-3.5	-1.4	0.2	425	500	ZK
CZMK 5.1	4.80	5.40	40	60	2.0	2	-2.7	-0.8	1.2	400	480	ZL
CZMK 5.6	5.20	6.00	15	40	1.0	2	-2.0	-1.2	2.5	80	400	ZM
CZMK 6.2	5.80	6.60	6	10	3.0	4	0.4	2.3	3.7	40	150	ZN
CZMK 6.8	6.40	7.20	6	15	2.0	4	1.2	3.0	4.5	30	80	ZP
CZMK 7.5	7.00	7.90	6	15	1.0	5	2.5	4.0	5.3	30	80	ZT
CZMK 8.2	7.70	8.70	6	15	0.7	5	3.2	4.6	6.2	40	80	ZV
CZMK 9.1	8.50	9.60	6	15	0.5	6	3.8	5.5	7.0	40	100	ZW
CZMK 10	9.40	10.60	8	20	0.2	7	4.5	6.4	8.0	50	150	ZX

# SILICON PLANAR ZENER DIODES

# CZMK3V3-39V

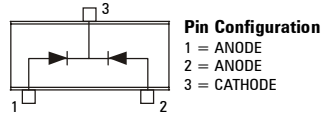
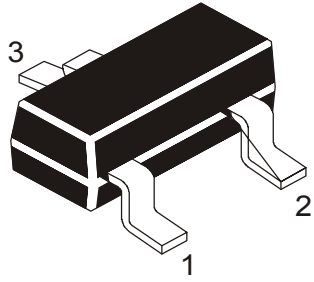

## SOT-23 Formed SMD Package

### ELECTRICAL CHARACTERISTICS Per Diode ( $T_a=25^\circ\text{C}$ $V_F < 0.9\text{V max}$ , $I_F=10\text{mA}$ )

Device #	Working Voltage		Differential Resistance		Reverse Current		Temperature Coefficient			Differential Resistance		Marking	
	$V_Z(\text{V})^{***}$ @ $I_{Z\text{test}}=5\text{mA}$		$r_{\text{diff}}(\Omega)$ @ $I_{Z\text{test}}=5\text{mA}$		$I_R$		$S_Z(\text{mV/K})$ @ $I_{Z\text{test}}=5\text{mA}$			$r_{\text{diff}}(\Omega)$ @ $I_{Z\text{test}}=1\text{mA}$			
	min	max	typ	max	$\mu\text{A}$	V	min	typ	max	typ	max		
CZMK 11	10.40	11.60	10	20	0.1	8.0	5.4	7.4	9.0	50	150	ZY	
CZMK 12	11.40	12.70	10	25	0.1	8.0	6.0	8.4	10	50	150	ZZ	
CZMK 13	12.40	14.10	10	30	0.1	8.0	7.0	9.4	11	50	170	YB	
CZMK 15	13.80	15.60	10	30	0.05	10.5	9.2	11.4	13	50	200	YC	
CZMK 16	15.30	17.10	10	40	0.05	11.2	10.4	12.4	14	50	200	YD	
CZMK 18	16.80	19.10	10	45	0.05	12.6	12.4	14.4	16	50	225	YE	
CZMK 20	18.80	21.20	15	55	0.05	14.0	14.4	16.4	18	60	225	YF	
CZMK 22	20.80	23.30	20	55	0.05	15.4	16.4	18.4	20	60	250	YG	
CZMK 24	22.80	25.60	25	70	0.05	16.8	18.4	20.4	22	60	250	YH	
	@ $I_{Z\text{test}}=2\text{mA}$		@ $I_{Z\text{test}}=2\text{mA}$					@ $I_{Z\text{test}}=2\text{mA}$			@ $I_{Z\text{test}}=0.5\text{mA}$		
CZMK 27	25.10	28.90	25	80	0.05	18.9	21.4	23.4	25.3	65	300	YJ	
CZMK 30	28.00	32.00	30	80	0.05	21.0	24.4	26.6	29.4	70	300	YK	
CZMK 33	31.00	35.00	35	80	0.05	23.1	27.4	29.7	33.4	75	325	YL	
CZMK 36	34.00	38.00	35	90	0.05	25.2	30.4	33.0	37.4	80	350	YM	
CZMK 39	37.00	41.00	40	130	0.05	27.3	33.4	36.4	41.2	80	350	YN	

\*\*\*Pulse test  $20\text{ms} \leq t_p \leq 50\text{ms}$ .

SOT-23 Formed SMD Package

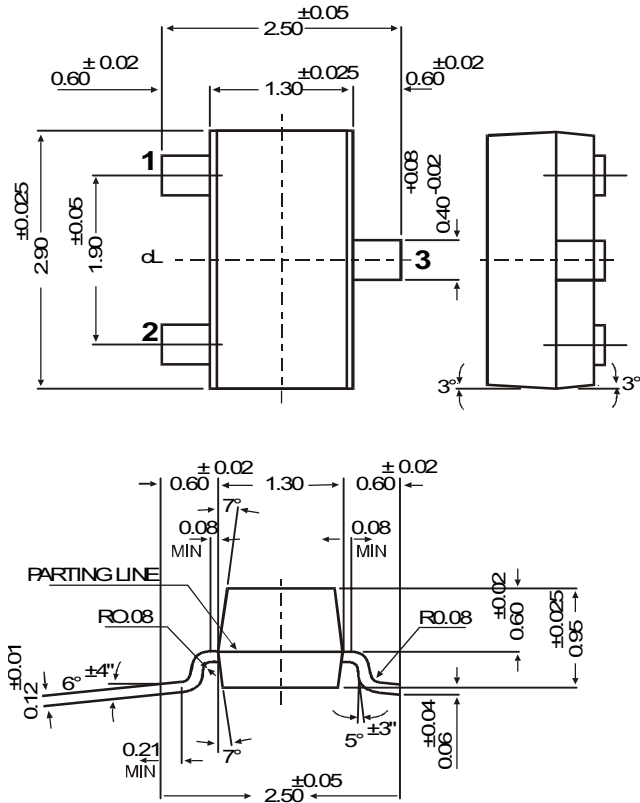

SOT-23 Package Reel Information  
Reel specification for W" Packing (13" reel)

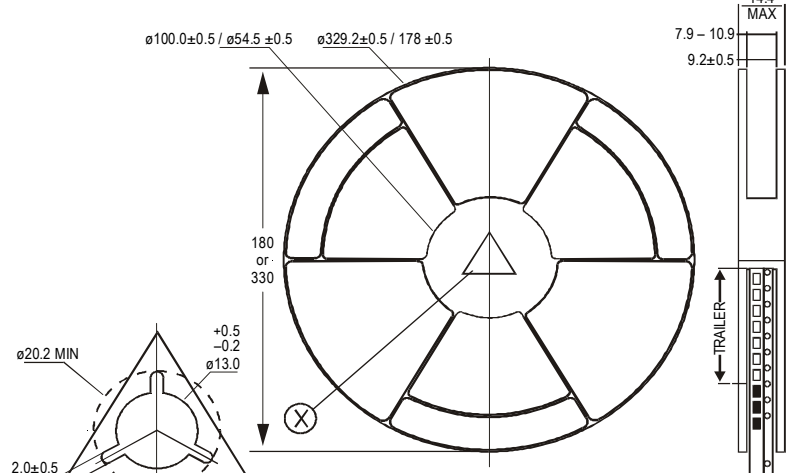

All dimensions in mm  
330 / 180 mm – Antistatic Coated Plastic Reel

NOTES:

- |    | 8mm Tape<br>Size of Reel<br>330 mm (13")<br>No. of Devices<br>10,000 Pcs   | 8mm Tape<br>Size of Reel<br>180 mm (7")<br>No. of Devices<br>3,000 Pcs |
|----|--|--|
| 1. | The bandolier of 330 mm reel contains at least 10,000 devices.   |  |
| 2. | The bandolier of 180 mm reel contains at least 3,000 devices.  |  |
| 3. | No more than 0.5% missing devices / reel. 50 empty compartments for 330 mm reel. 15 empty compartments for 180 mm reel.  |  |
| 4. | Three consecutive empty places might be found provided this gap is followed by 6 consecutive devices.  |  |
| 5. | The carrier tape (leader) starts with at least 75 empty positions (equivalent to 330 mm). In order to fix the carrier tape a self adhesive tape of 20 to 50 mm is applied. At the end of the bandolier at least 40 empty positions (equivalent to 160 mm) are there. |  |

Tape Specification for SOT-23 Surface Mount Device

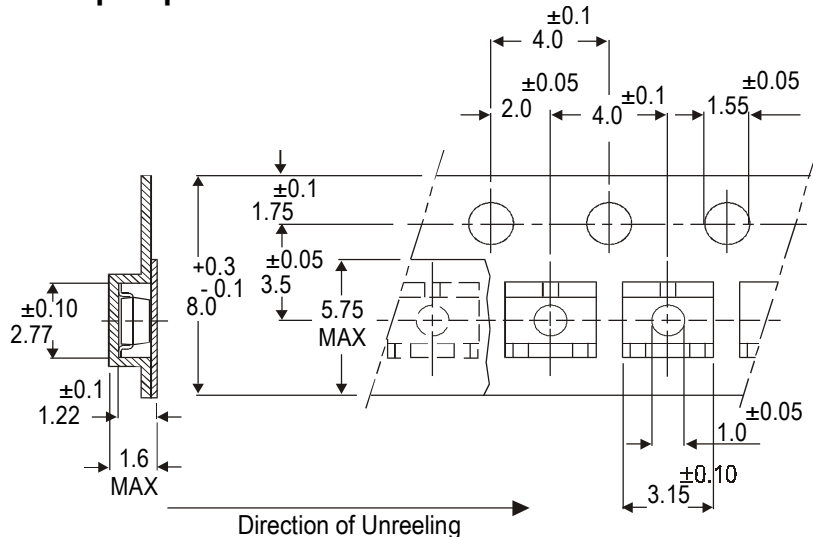

All dimensions in mm

Packing Detail

PACKAGE	STANDARD PACK		INNER CARTON BOX		OUTER CARTON BOX		
	Details	Net Weight/Qty	Size	Qty	Size	Qty	Gr Wt
SOT-23 T&R	3K/reel	136 gm/3K pcs	3" x 7.5" x 7.5"	12 K	17" x 15" x 13.5"	192 K	12 kgs
	10K/reel	415 gm/10K pcs	9" x 9" x 9" 13" x 13" x 0.5"	51 K 10 K	19" x 19" x 19" 17" x 15" x 13.5"	408 K 300 K	28 kgs 16 kgs

### **Disclaimer**

The product information and the selection guides facilitate selection of the CDIL's Discrete Semiconductor Device(s) best suited for application in your product(s) as per your requirement. It is recommended that you completely review our Data Sheet(s) so as to confirm that the Device(s) meet functionality parameters for your application. The information furnished in the Data Sheet and on the CDIL Web Site/CD are believed to be accurate and reliable. CDIL however, does not assume responsibility for inaccuracies or incomplete information. Furthermore, CDIL does not assume liability whatsoever, arising out of the application or use of any CDIL product; neither does it convey any license under its patent rights nor rights of others. These products are not designed for use in life saving/support appliances or systems. CDIL customers selling these products (either as individual Discrete Semiconductor Devices or incorporated in their end products), in any life saving/support appliances or systems or applications do so at their own risk and CDIL will not be responsible for any damages resulting from such sale(s).

CDIL strives for continuous improvement and reserves the right to change the specifications of its products without prior notice.



CDIL is a registered Trademark of

**Continental Device India Limited**

C-120 Naraina Industrial Area, New Delhi 110 028, India.

Telephone + 91-11-2579 6150, 5141 1112 Fax + 91-11-2579 5290, 5141 1119

email@cdil.com www.cdilsemi.com