

MECHANICAL DATA

**GOLD METALLISED
MULTI-PURPOSE SILICON
DMOS RF FET
150W – 28V – 400MHz
PUSH-PULL**

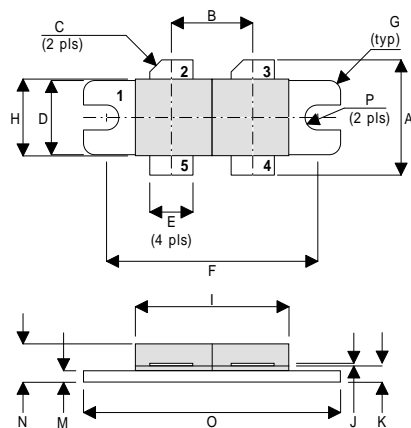

DR

PIN 1 SOURCE (COMMON) PIN 2 DRAIN 1
 PIN 3 DRAIN 2 PIN 4 GATE 2
 PIN 5 GATE 1

DIM	Millimetres	Tol.	Inches	Tol.
A	19.05	0.50	0.75	0.020
B	10.77	0.13	0.424	0.005
C	45°	5°	45°	5°
D	9.78	0.13	0.385	0.005
E	5.71	0.13	0.225	0.005
F	27.94	0.13	1.100	0.005
G	1.52R	0.13	0.060R	0.005
H	10.16	0.13	0.400	0.005
I	22.22	MAX	0.875	MAX
J	0.13	0.02	0.005	0.001
K	2.72	0.13	0.107	0.005
M	1.70	0.13	0.067	0.005
N	5.08	0.50	0.200	0.020
O	34.03	0.13	1.340	0.005
P	1.57R	0.08	0.062R	0.003

FEATURES

- EXTRA LOW C_{rss}
- SIMPLIFIED AMPLIFIER DESIGN
- SUITABLE FOR BROAD BAND APPLICATIONS
- SIMPLE BIAS CIRCUITS
- LOW NOISE
- HIGH GAIN – 10 dB MINIMUM

APPLICATIONS

- HF/VHF/UHF COMMUNICATIONS
from 1 MHz to 400 MHz

ABSOLUTE MAXIMUM RATINGS ($T_{case} = 25^{\circ}C$ unless otherwise stated)

P_D	Power Dissipation	389W
BV_{DSS}	Drain – Source Breakdown Voltage *	70V
BV_{GSS}	Gate – Source Breakdown Voltage *	$\pm 20V$
$I_{D(sat)}$	Drain Current *	20A
T_{stg}	Storage Temperature	-65 to $150^{\circ}C$
T_j	Maximum Operating Junction Temperature	$200^{\circ}C$

* Per Side

ELECTRICAL CHARACTERISTICS (T_{case} = 25°C unless otherwise stated)

Parameter	Test Conditions	Min.	Typ.	Max.	Unit
PER SIDE					
B _V DSS	Drain–Source Breakdown Voltage	V _{GS} = 0	I _D = 100mA	70	V
I _{DSS}	Zero Gate Voltage Drain Current	V _{DS} = 28V	V _{GS} = 0		5 mA
I _{GSS}	Gate Leakage Current	V _{GS} = 20V	V _{DS} = 0		1 μA
V _{GS(th)}	Gate Threshold Voltage*	I _D = 10mA	V _{DS} = V _{GS}	1	7 V
g _{fs}	Forward Transconductance*	V _{DS} = 10V	I _D = 5A	4	S
TOTAL DEVICE					
G _{PS}	Common Source Power Gain	P _O = 150W		10	dB
η	Drain Efficiency	V _{DS} = 28V	I _{DQ} = 2A	50	%
VSWR	Load Mismatch Tolerance	f = 400MHz		20:1	—
PER SIDE					
C _{iss}	Input Capacitance	V _{DS} = 28V	V _{GS} = -5V f = 1MHz		300 pF
C _{oss}	Output Capacitance	V _{DS} = 28V	V _{GS} = 0 f = 1MHz		150 pF
C _{rss}	Reverse Transfer Capacitance	V _{DS} = 28V	V _{GS} = 0 f = 1MHz		10 pF

* Pulse Test: Pulse Duration = 300 μs , Duty Cycle ≤ 2%

HAZARDOUS MATERIAL WARNING

The ceramic portion of the device between leads and metal flange is beryllium oxide. Beryllium oxide dust is highly toxic and care must be taken during handling and mounting to avoid damage to this area.

THESE DEVICES MUST NEVER BE THROWN AWAY WITH GENERAL INDUSTRIAL OR DOMESTIC WASTE.

THERMAL DATA

R _{THj-case}	Thermal Resistance Junction – Case	Max. 0.45°C / W
-----------------------	------------------------------------	-----------------

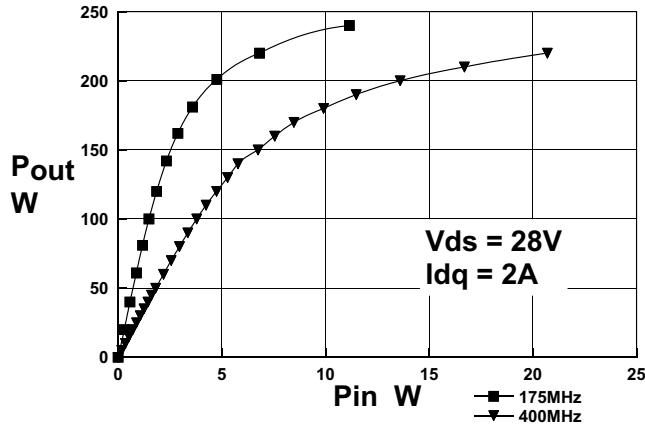

Figure 1. Output Power Vs Input Power

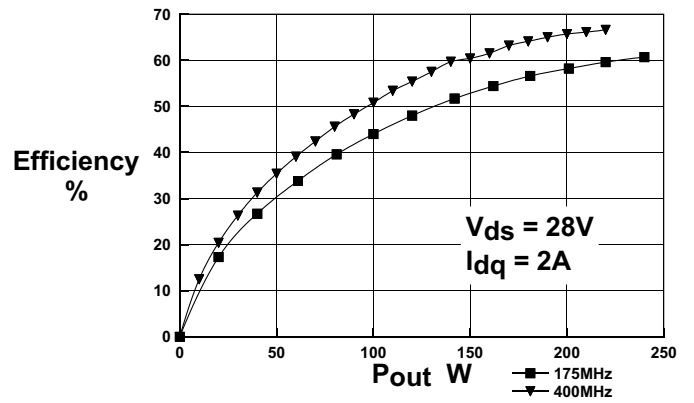

Figure 2. Efficiency Vs. Output Power

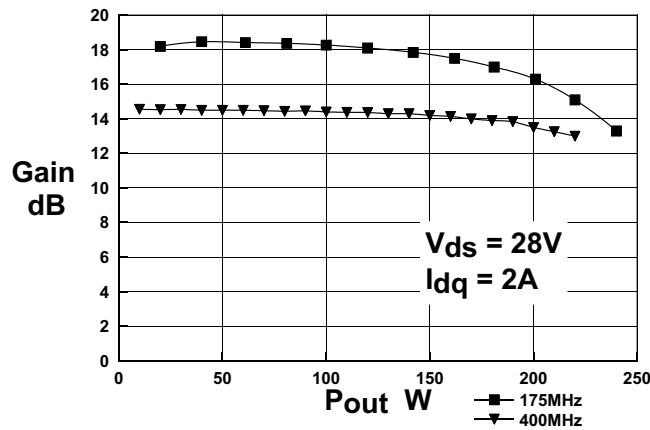
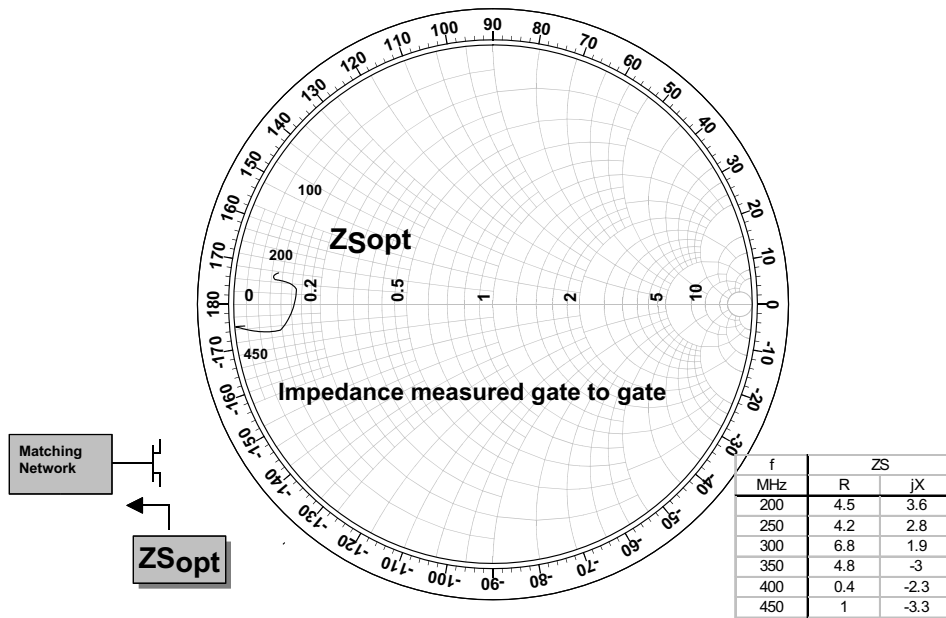
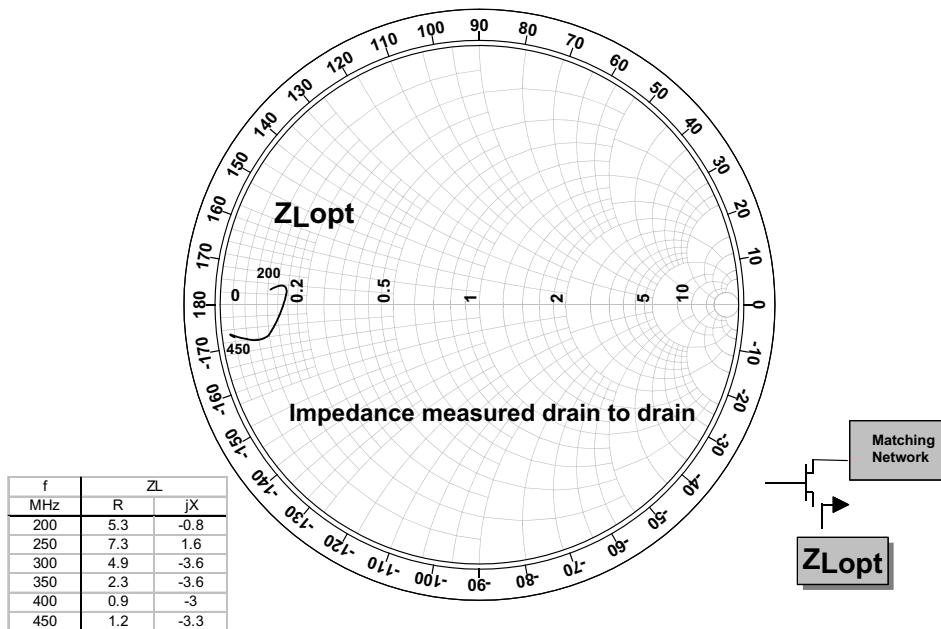

Figure 3. Gain Vs Output Power



Optimum Source Impedence



Optimum Load Impedence

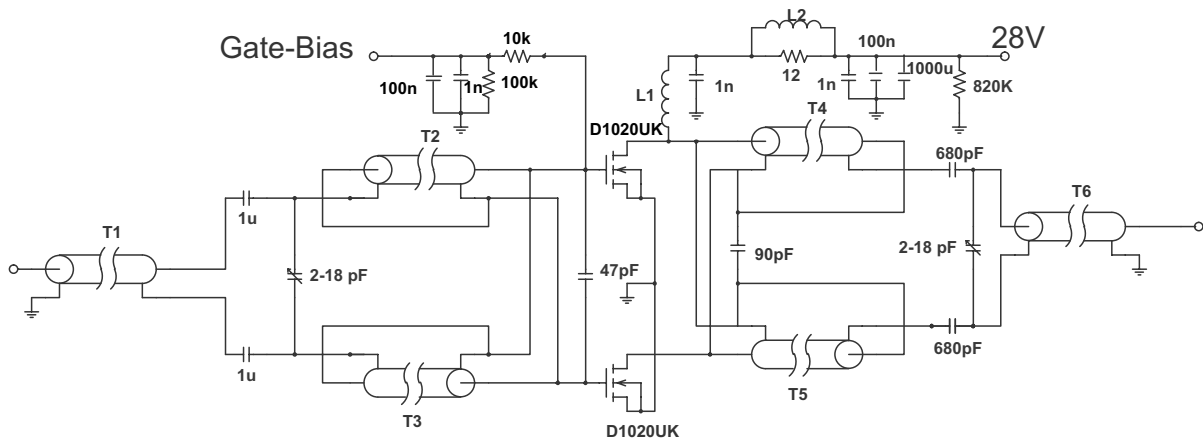

175 MHz Test Fixture

- T1,2,3 7cm Storm Products EXE 18 19/30 S1TW coaxial cable on Siemens A1 x 1 2 hole core
- T4,5 14cm Storm products EXE18 19/30 S1TW coaxial cable
- T6 11cm Storm products EXE 18 19/30 S1TW coaxial cable
- L1 6 turns 1.2mm dia wire, 5mm internal diameter
- L2 1.5 turns 0.9mm dia wire on Siemens A1 x 1 2 hole core

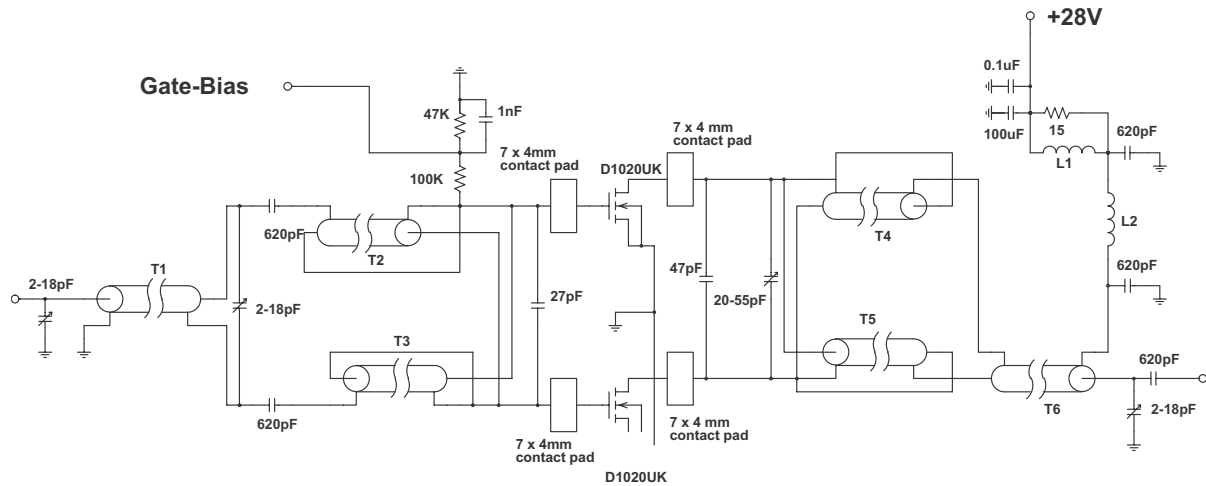

400 MHz Test Fixture

- T1 11cm 50 Ohm UT47 semi-rigid coax
- T2,3,4,5 8.9cm 18 Ohm UT62-18 semi-rigid coax
- T6 9.4cm 50 Ohm UT85 semi-rigid coax
- L1 5.5 turns 18swg enamelled copper wire on Fair-Rite FT50B-43 ferrite core
- L2 6 turns 18swg enamelled copper wire, 3.5mm internal diameter