



STD30NF03L STD30NF03L-1

N-channel 30V - 0.020Ω - 30A - DPAK/IPAK
STripFET™ II Power MOSFET

General features

Type	V _{DSS}	R _{DS(on)}	I _D
STD30NF03L-1	30V	< 0.025Ω	30A
STD30NF03L	30V	< 0.025Ω	30A

- Low threshold drive

Description

This Power MOSFET is the latest development of STMicroelectronics unique "Single Feature Size™" strip-based process. The resulting transistor shows extremely high packing density for low on-resistance, rugged avalanche characteristics and less critical alignment steps therefore a remarkable manufacturing reproducibility.

Applications

- Switching application

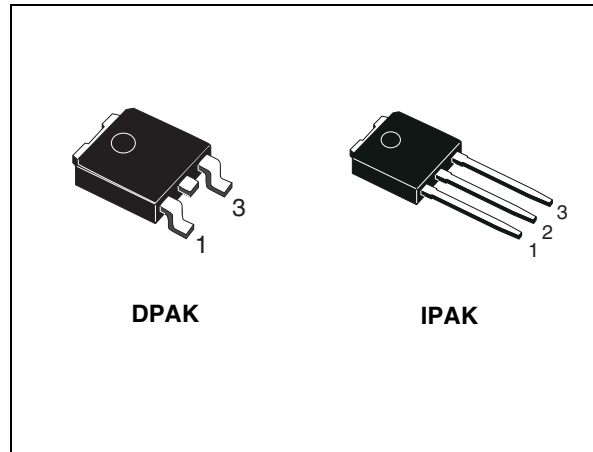

Internal schematic diagram

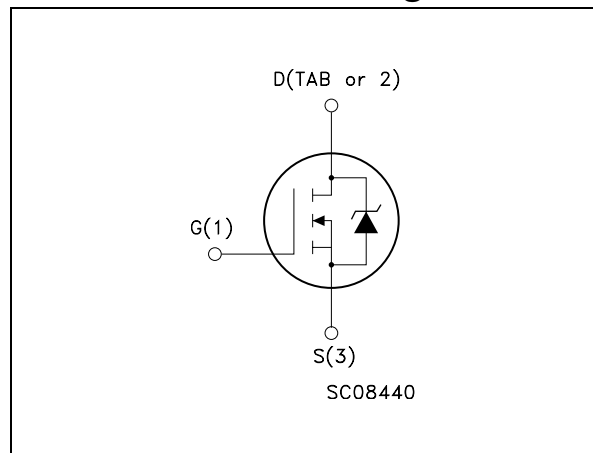

Order codes

Part number	Marking	Package	Packaging
STD30NF03L-1	D30NF03L	IPAK	Tube
STD30NF03LT4	D30NF03L	DPAK	Tape & reel

Contents

1	Electrical ratings	3
2	Electrical characteristics	4
2.1	Electrical characteristics (curves)	6
3	Test circuit	8
4	Package mechanical data	9
5	Packing mechanical data	12
6	Revision history	13

1 Electrical ratings

Table 1. Absolute maximum ratings

Symbol	Parameter	Value	Unit
V_{DS}	Drain-source voltage ($V_{GS} = 0$)	30	V
V_{DGR}	Drain-gate voltage ($R_{GS} = 20\text{ k}\Omega$)	30	V
V_{GS}	Gate- source voltage	± 20	V
$I_D^{(1)}$	Drain current (continuous) at $T_C = 25^\circ\text{C}$	30	A
I_D	Drain current (continuous) at $T_C = 100^\circ\text{C}$	19	A
$I_{DM}^{(2)}$	Drain current (pulsed)	120	A
P_{tot}	Total dissipation at $T_C = 25^\circ\text{C}$	50	W
	Derating Factor	0.27	W/ $^\circ\text{C}$
$E_{AS}^{(3)}$	Single pulse avalanche energy	100	mJ
T_{stg}	Storage temperature	-65 to 175	$^\circ\text{C}$
T_j	Max. operating junction temperature		

1. Current limited by package
2. Pulse width limited by safe operating area.
3. Starting $T_j = 25^\circ\text{C}$, $I_D = 15\text{A}$ $V_{DD} = 15\text{V}$

Table 2. Thermal data

$R_{thj-pcb}$	Thermal resistance junction-pcb max	3.0	$^\circ\text{C}/\text{W}$
$R_{thj-amb}$	Thermal resistance junction-ambient max	100	$^\circ\text{C}/\text{W}$
$R_{thj-sink}$	Thermal resistance case-sink max	1.5	$^\circ\text{C}/\text{W}$
T_J	Maximum lead temperature for soldering purpose	275	$^\circ\text{C}$

2 Electrical characteristics

($T_{CASE}=25^{\circ}C$ unless otherwise specified)

Table 3. On/off states

Symbol	Parameter	Test conditions	Min.	Typ.	Max.	Unit
$V_{(BR)DSS}$	Drain-source breakdown voltage	$I_D = 250\mu A, V_{GS} = 0$	30			V
I_{DSS}	Zero gate voltage drain current ($V_{GS} = 0$)	$V_{DS} = \text{Max rating}$ $V_{DS} = \text{Max rating},$ $T_C = 125^{\circ}C$			1 10	μA μA
I_{GSS}	Gate-body leakage current ($V_{DS} = 0$)	$V_{GS} = \pm 20V$			± 100	nA
$V_{GS(th)}$	Gate threshold voltage	$V_{DS} = V_{GS}, I_D = 250\mu A$	1	1.7	2.5	V
$R_{DS(on)}$	Static drain-source on resistance	$V_{GS} = 10V, I_D = 15A$ $V_{GS} = 4.5V, I_D = 15A$		0.020 0.028	0.025 0.035	Ω Ω

Table 4. Dynamic

Symbol	Parameter	Test conditions	Min.	Typ.	Max.	Unit
$g_{fs}^{(1)}$	Forward transconductance	$V_{DS} = 15V, I_D = 15A$		13		S
C_{iss}	Input capacitance	$V_{DS} = 25V, f = 1MHz,$ $V_{GS} = 0$		830		pF
C_{oss}	Output capacitance			230		pF
C_{rss}	Reverse transfer capacitance			92		pF
$t_{d(on)}$	Turn-on delay time	$V_{DD} = 15V, I_D = 20A$ $R_G = 4.7\Omega, V_{GS} = 4.5V$ (see Figure 12)		35		ns
t_r	Rise time			205		ns
$t_{d(off)}$	Turn-off delay time			90		ns
t_f	Fall time			240		ns
Q_g	Total gate charge	$V_{DD} = 24V, I_D = 30A,$ $V_{GS} = 5V, R_G = 4.7\Omega$ (see Figure 13)		18		nC
Q_{gs}	Gate-source charge			7		nC
Q_{gd}	Gate-drain charge			8		nC

1. Pulsed: Pulse duration = 300 μs , duty cycle 1.5%.

Table 5. Source drain diode

Symbol	Parameter	Test conditions	Min.	Typ.	Max.	Unit
I_{SD} $I_{SDM}^{(1)}$	Source-drain current Source-drain current (pulsed)				30 240	A A
$V_{SD}^{(2)}$	Forward on voltage	$I_{SD} = 30A, V_{GS} = 0$			1.5	V
t_{rr} Q_{rr} I_{RRM}	Reverse recovery time Reverse recovery charge Reverse recovery current	$I_{SD} = 40A, di/dt = 100A/\mu s,$ $V_{DD} = 15V, T_j = 150^\circ C$ (see Figure 14)		65 72 2		ns nC A

1. Pulse width limited by safe operating area.
2. Pulsed: Pulse duration = 300 μs , duty cycle 1.5%

2.1 Electrical characteristics (curves)

Figure 1. Safe operating area

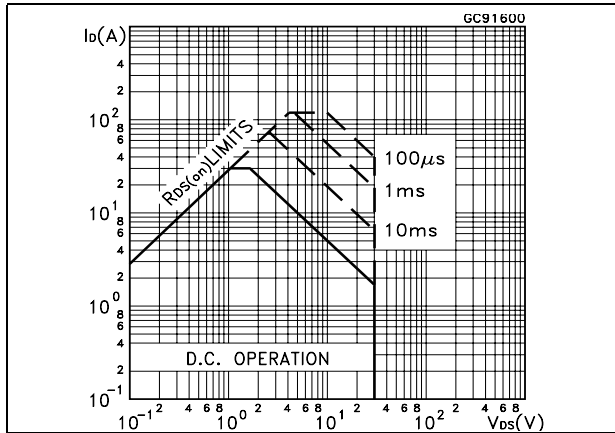

Figure 2. Thermal impedance

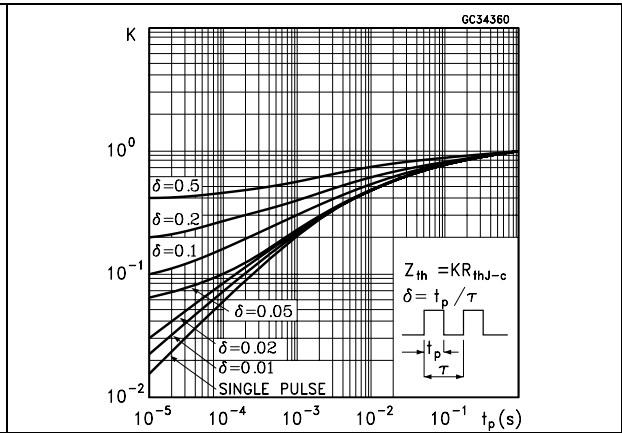

Figure 3. Output characteristics

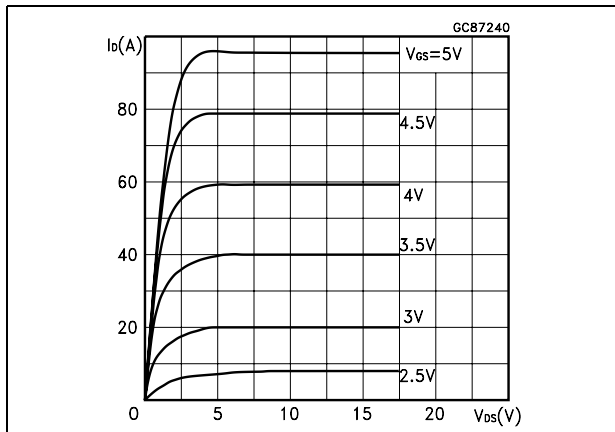

Figure 4. Transfer characteristics

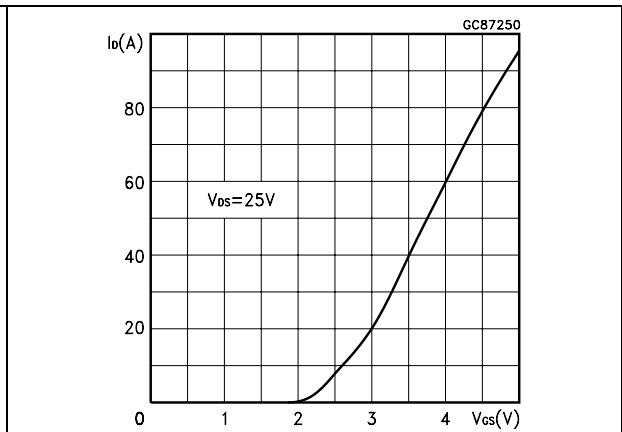

Figure 5. Transconductance

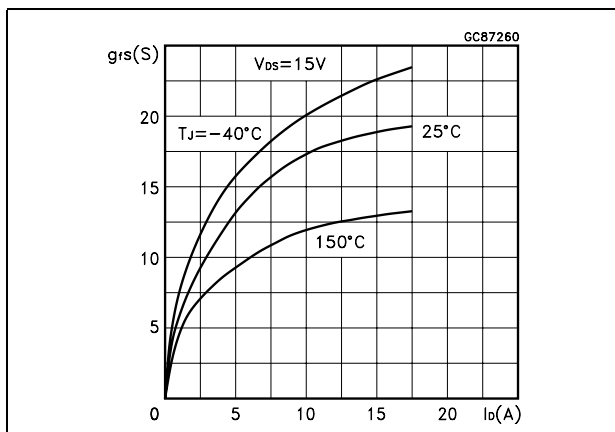

Figure 6. Static drain-source on resistance

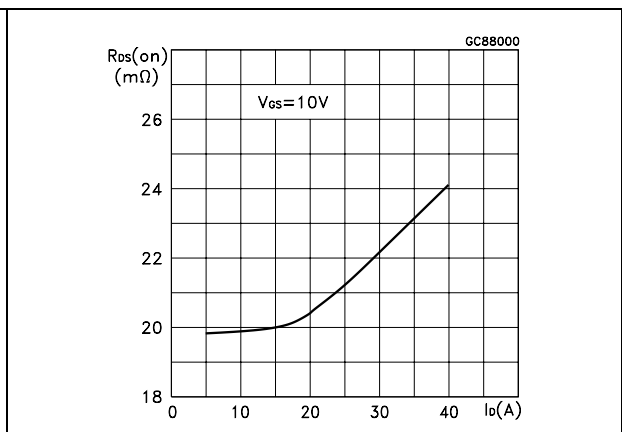

Figure 7. Gate charge vs. gate-source voltage Figure 8. Capacitance variations

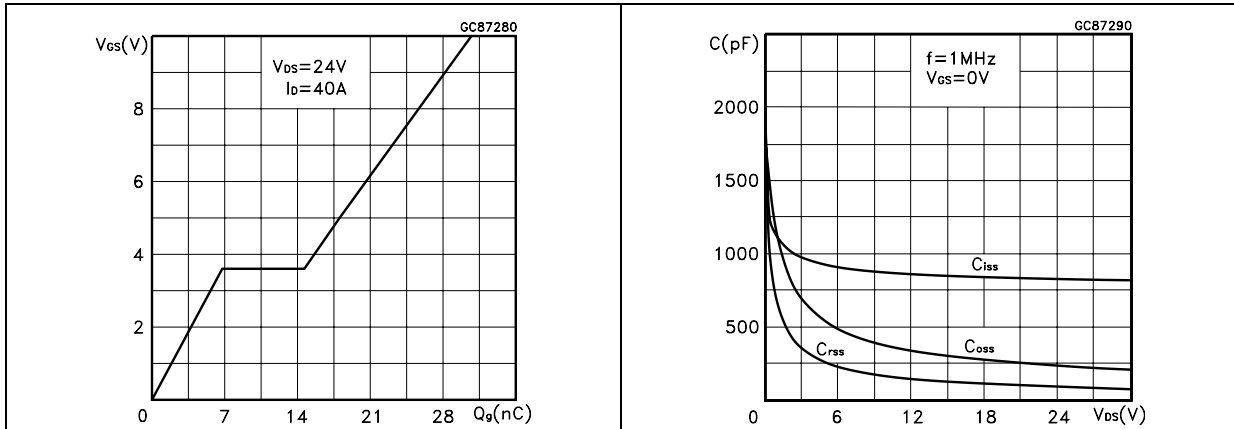

Figure 9. Normalized gate threshold voltage vs. temperature Figure 10. Normalized on resistance vs. temperature

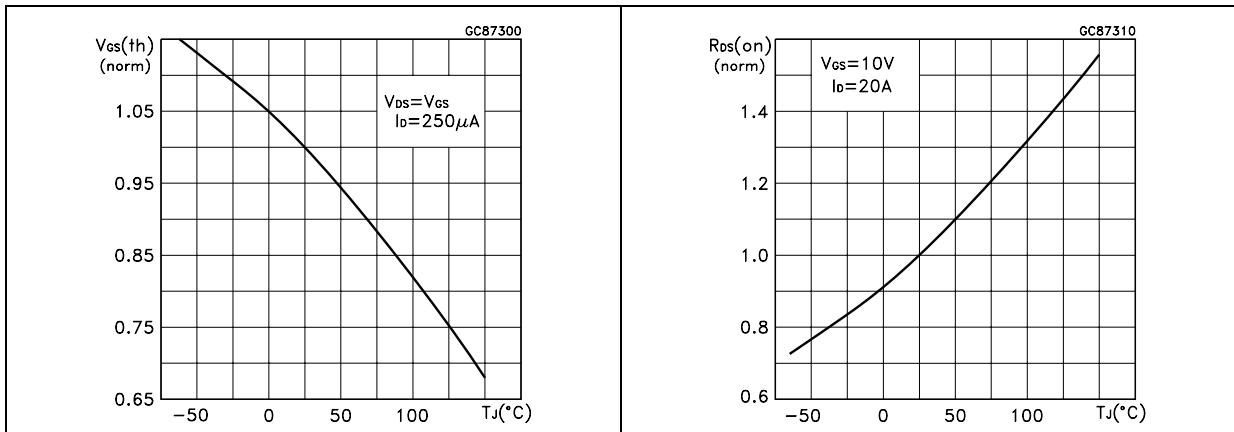
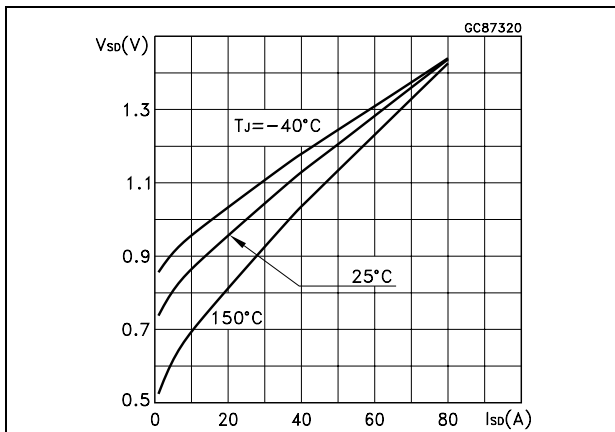

Figure 11. Source-drain diode forward characteristics



3 Test circuit

Figure 12. Switching times test circuit for resistive load



Figure 13. Gate charge test circuit



Figure 14. Test circuit for inductive load switching and diode recovery times



Figure 15. Unclamped Inductive load test circuit



Figure 16. Unclamped inductive waveform



Figure 17. Switching time waveform



4 Package mechanical data

In order to meet environmental requirements, ST offers these devices in ECOPACK® packages. These packages have a Lead-free second level interconnect. The category of second level interconnect is marked on the package and on the inner box label, in compliance with JEDEC Standard JESD97. The maximum ratings related to soldering conditions are also marked on the inner box label. ECOPACK is an ST trademark. ECOPACK specifications are available at: www.st.com

DPAK MECHANICAL DATA

DIM.	mm.			inch		
	MIN.	TYP.	MAX.	MIN.	TYP.	MAX.
A	2.2		2.4	0.086		0.094
A1	0.9		1.1	0.035		0.043
A2	0.03		0.23	0.001		0.009
B	0.64		0.9	0.025		0.035
b4	5.2		5.4	0.204		0.212
C	0.45		0.6	0.017		0.023
C2	0.48		0.6	0.019		0.023
D	6		6.2	0.236		0.244
D1		5.1			0.200	
E	6.4		6.6	0.252		0.260
E1		4.7			0.185	
e		2.28			0.090	
e1	4.4		4.6	0.173		0.181
H	9.35		10.1	0.368		0.397
L	1			0.039		
(L1)		2.8			0.110	
L2		0.8			0.031	
L4	0.6		1	0.023		0.039
R		0.2			0.008	
V2	0°		8°	0°		8°



TO-251 (IPAK) MECHANICAL DATA

DIM.	mm			inch		
	MIN.	TYP.	MAX.	MIN.	TYP.	MAX.
A	2.2		2.4	0.086		0.094
A1	0.9		1.1	0.035		0.043
A3	0.7		1.3	0.027		0.051
B	0.64		0.9	0.025		0.031
B2	5.2		5.4	0.204		0.212
B3			0.85			0.033
B5		0.3			0.012	
B6			0.95			0.037
C	0.45		0.6	0.017		0.023
C2	0.48		0.6	0.019		0.023
D	6		6.2	0.236		0.244
E	6.4		6.6	0.252		0.260
G	4.4		4.6	0.173		0.181
H	15.9		16.3	0.626		0.641
L	9		9.4	0.354		0.370
L1	0.8		1.2	0.031		0.047
L2		0.8	1		0.031	0.039

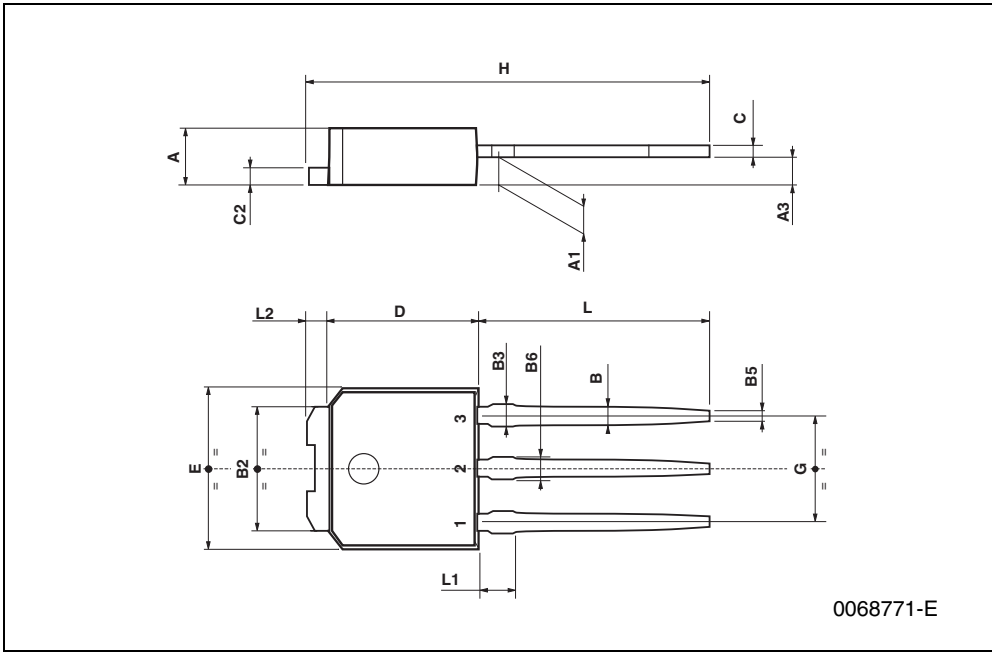

5 Packing mechanical data

DPAK FOOTPRINT



TAPE AND REEL SHIPMENT

40 mm min. Access hole at slot location

Full radius

Tape slot in core for tape start 2.5mm min. width

G measured at hub

REEL MECHANICAL DATA

DIM.	mm		inch	
	MIN.	MAX.	MIN.	MAX.
A		330		12.992
B	1.5		0.059	
C	12.8	13.2	0.504	0.520
D	20.2		0.795	
G	16.4	18.4	0.645	0.724
N	50		1.968	
T		22.4		0.881

TAPE MECHANICAL DATA

DIM.	mm		inch	
	MIN.	MAX.	MIN.	MAX.
A0	6.8	7	0.267	0.275
B0	10.4	10.6	0.409	0.417
B1		12.1		0.476
D	1.5	1.6	0.059	0.063
D1	1.5		0.059	
E	1.65	1.85	0.065	0.073
F	7.4	7.6	0.291	0.299
K0	2.55	2.75	0.100	0.108
P0	3.9	4.1	0.153	0.161
P1	7.9	8.1	0.311	0.319
P2	1.9	2.1	0.075	0.082
R	40		1.574	
W	15.7	16.3	0.618	0.641

TOP COVER TAPE

User Direction of Feed

Center line of cavity

Bending radius R min.

FEED DIRECTION

For machine ref. only including draft and radii concentric around B0

10 pitches cumulative tolerance on tape +/- 0.2 mm

6 Revision history

Table 6. Revision history

Date	Revision	Changes
21-Jun-2004	4	Preliminary version
03-Jul-2006	5	New template, no content change
20-Feb-2007	6	Typo mistake on page 1

Please Read Carefully:

Information in this document is provided solely in connection with ST products. STMicroelectronics NV and its subsidiaries ("ST") reserve the right to make changes, corrections, modifications or improvements, to this document, and the products and services described herein at any time, without notice.

All ST products are sold pursuant to ST's terms and conditions of sale.

Purchasers are solely responsible for the choice, selection and use of the ST products and services described herein, and ST assumes no liability whatsoever relating to the choice, selection or use of the ST products and services described herein.

No license, express or implied, by estoppel or otherwise, to any intellectual property rights is granted under this document. If any part of this document refers to any third party products or services it shall not be deemed a license grant by ST for the use of such third party products or services, or any intellectual property contained therein or considered as a warranty covering the use in any manner whatsoever of such third party products or services or any intellectual property contained therein.

UNLESS OTHERWISE SET FORTH IN ST'S TERMS AND CONDITIONS OF SALE ST DISCLAIMS ANY EXPRESS OR IMPLIED WARRANTY WITH RESPECT TO THE USE AND/OR SALE OF ST PRODUCTS INCLUDING WITHOUT LIMITATION IMPLIED WARRANTIES OF MERCHANTABILITY, FITNESS FOR A PARTICULAR PURPOSE (AND THEIR EQUIVALENTS UNDER THE LAWS OF ANY JURISDICTION), OR INFRINGEMENT OF ANY PATENT, COPYRIGHT OR OTHER INTELLECTUAL PROPERTY RIGHT.

UNLESS EXPRESSLY APPROVED IN WRITING BY AN AUTHORIZED REPRESENTATIVE OF ST, ST PRODUCTS ARE NOT DESIGNED, AUTHORIZED OR WARRANTED FOR USE IN MILITARY, AIR CRAFT, SPACE, LIFE SAVING, OR LIFE SUSTAINING APPLICATIONS, NOR IN PRODUCTS OR SYSTEMS, WHERE FAILURE OR MALFUNCTION MAY RESULT IN PERSONAL INJURY, DEATH, OR SEVERE PROPERTY OR ENVIRONMENTAL DAMAGE.

Resale of ST products with provisions different from the statements and/or technical features set forth in this document shall immediately void any warranty granted by ST for the ST product or service described herein and shall not create or extend in any manner whatsoever, any liability of ST.

ST and the ST logo are trademarks or registered trademarks of ST in various countries.

Information in this document supersedes and replaces all information previously supplied.

The ST logo is a registered trademark of STMicroelectronics. All other names are the property of their respective owners.

© 2007 STMicroelectronics - All rights reserved

STMicroelectronics group of companies

Australia - Belgium - Brazil - Canada - China - Czech Republic - Finland - France - Germany - Hong Kong - India - Israel - Italy - Japan - Malaysia - Malta - Morocco - Singapore - Spain - Sweden - Switzerland - United Kingdom - United States of America

www.st.com