

SHINDENGEN

Super Fast Recovery Rectifiers

Super Fast Bridges

D4SBL40

400V 4A

FEATURES

Low noise
SIL Package
High IFSM

APPLICATION

Switching power supply
Home (Electrical) Appliances
Office Equipment, Telecommunication,
Factory Automation

OUTLINE DIMENSIONS

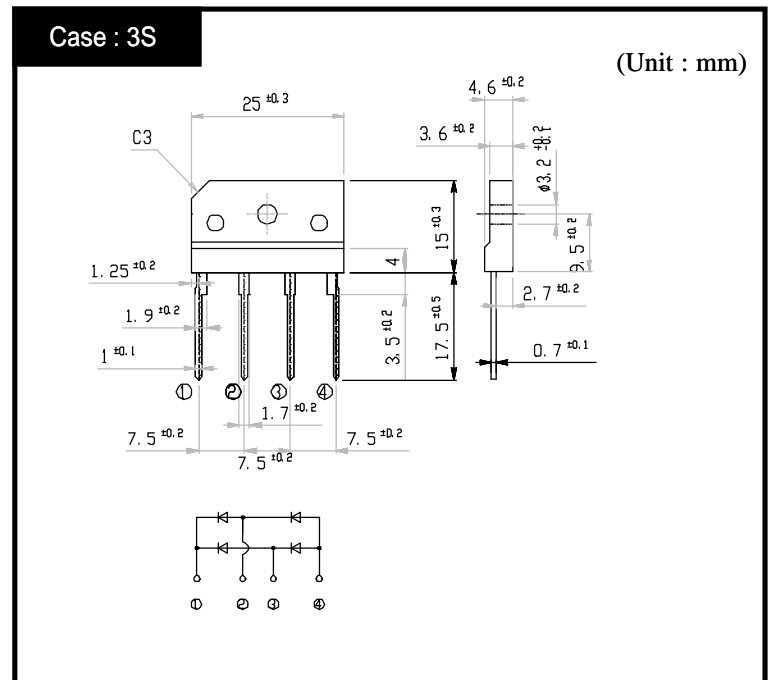

RATINGS

Absolute Maximum Ratings (If not specified $T_c=25$)

Item	Symbol	Conditions	Ratings	Unit
Storage Temperature	T_{stg}		-55 ~ 150	
Operating Junction Temperature	T_j		150	
Maximum Reverse Voltage	V_{RM}		400	V
Average Rectified Forward Current	I_O	50Hz sine wave, R-load With heatsink $T_c=91$	4	A
		50Hz sine wave, R-load Without heatsink $T_a=25$	1.95	
Peak Surge Forward Current	I_{FSM}	50Hz sine wave, Non-repetitive 1cycle peak value, $T_j=25$	50	A
Dielectric Strength	V_{dis}	Terminals to case, AC 1 minute	2	kV
Mounting Torque	TOR	(Recommended torque $0.5N \cdot m$)	0.8	$N \cdot m$

Electrical Characteristics (If not specified $T_l=25$)

Item	Symbol	Conditions	Ratings	Unit
Forward Voltage	V_F	$I_F=2.5A$, Pulse measurement, Rating of per diode	Max.1.3	V
Reverse Current	I_R	$V_R=V_{RM}$, Pulse measurement, Rating of per diode	Max.10	μA
Reverse Recovery Time	trr	$I_F = 0.5A$, $I_R = 1A$	Max.50	ns
Thermal Resistance	θ_{jc}	junction to case With heatsink	Max.5.5	/W
	θ_{jl}	junction to lead Without heatsink	Max.6	
	θ_{ja}	junction to ambient Without heatsink	Max.30	

D4SBL40

Forward Voltage

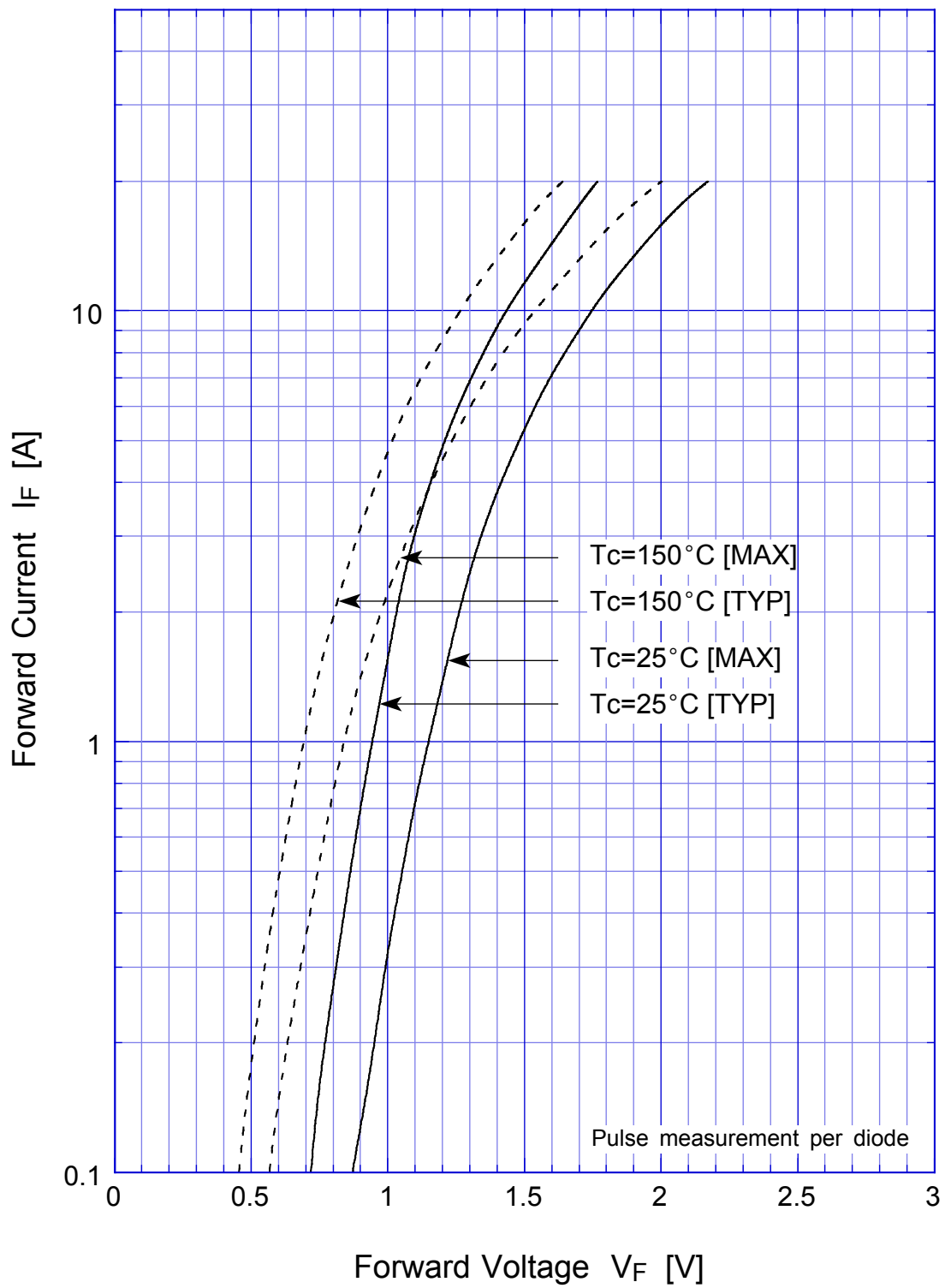

D4SBL40 Junction Capacitance

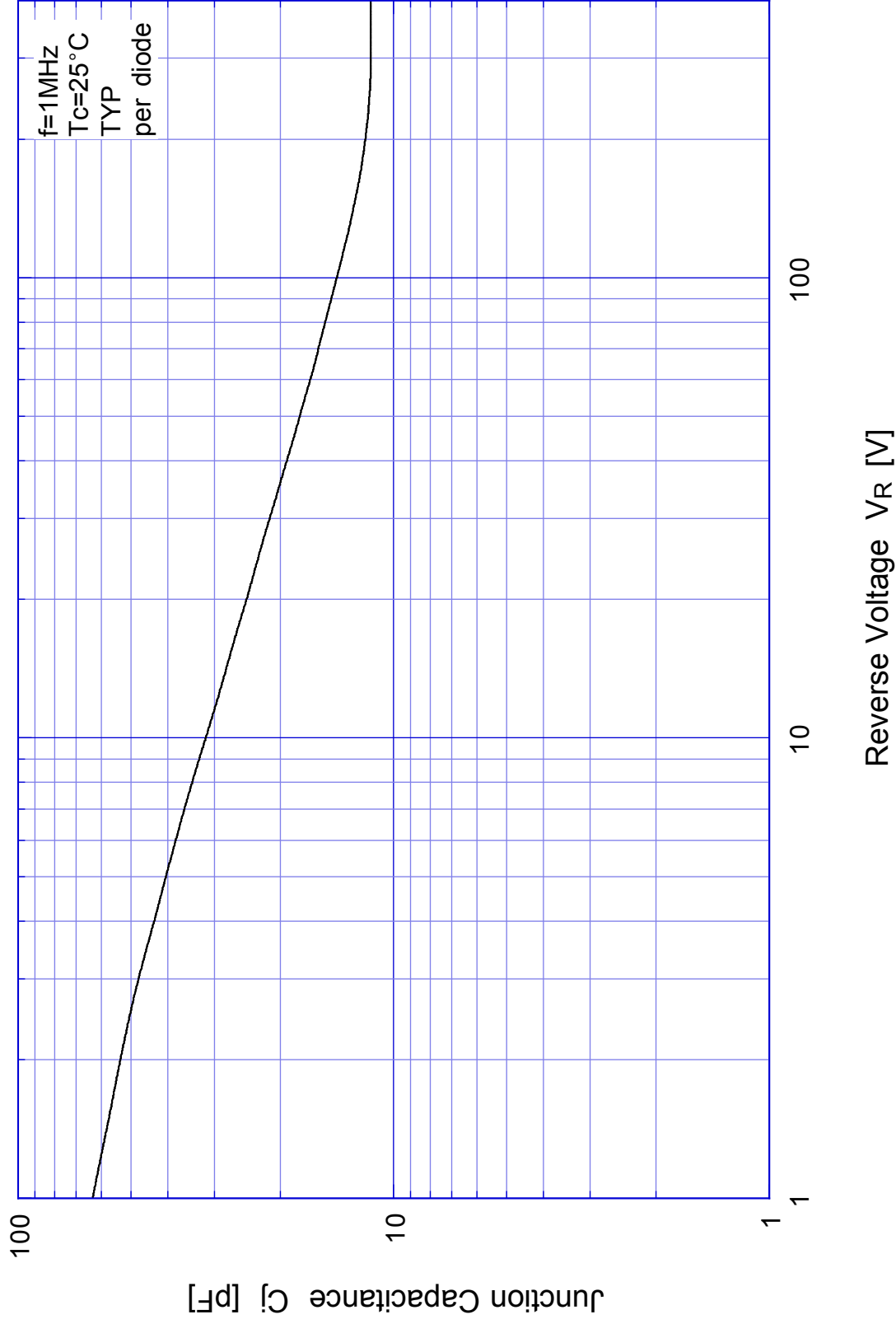

D4SBL40 Forward Power Dissipation

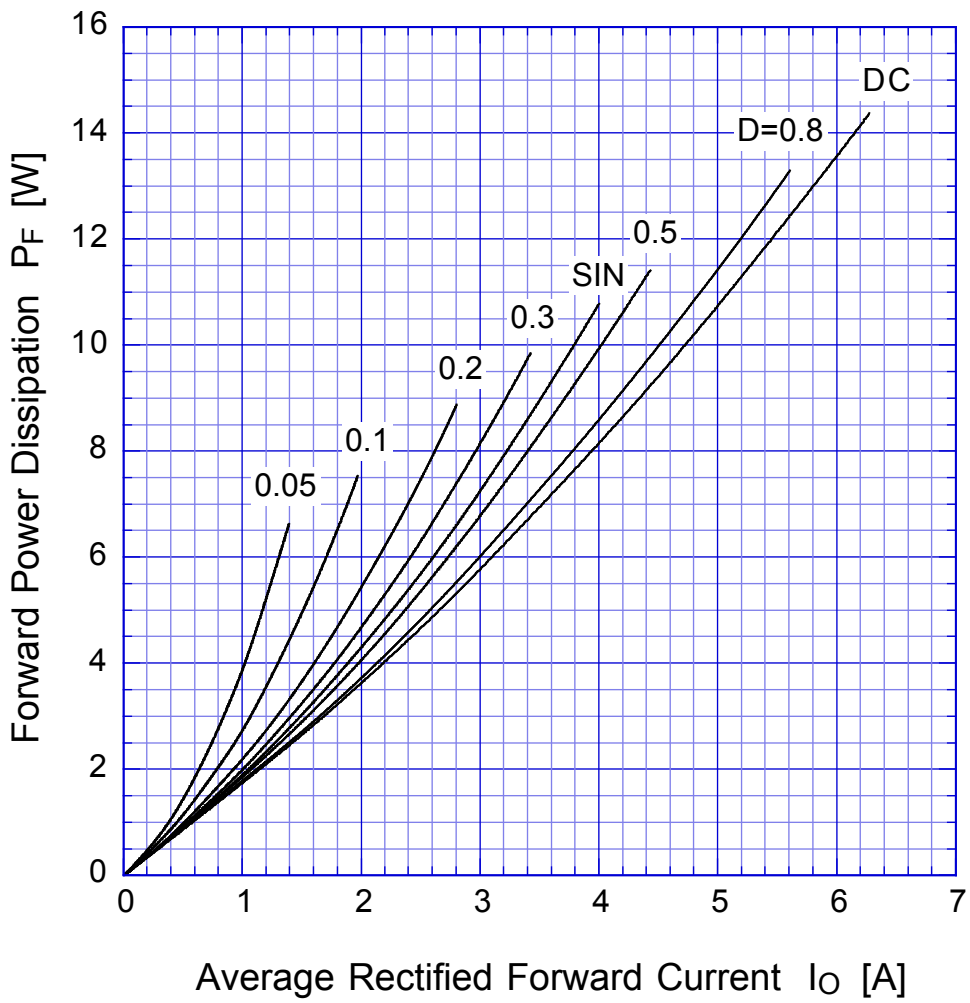

$T_j = 150^\circ\text{C}$

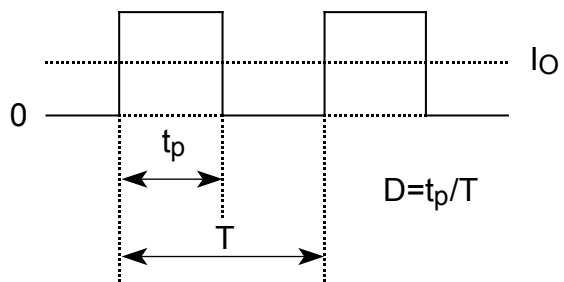

D4SBL40

Derating Curve

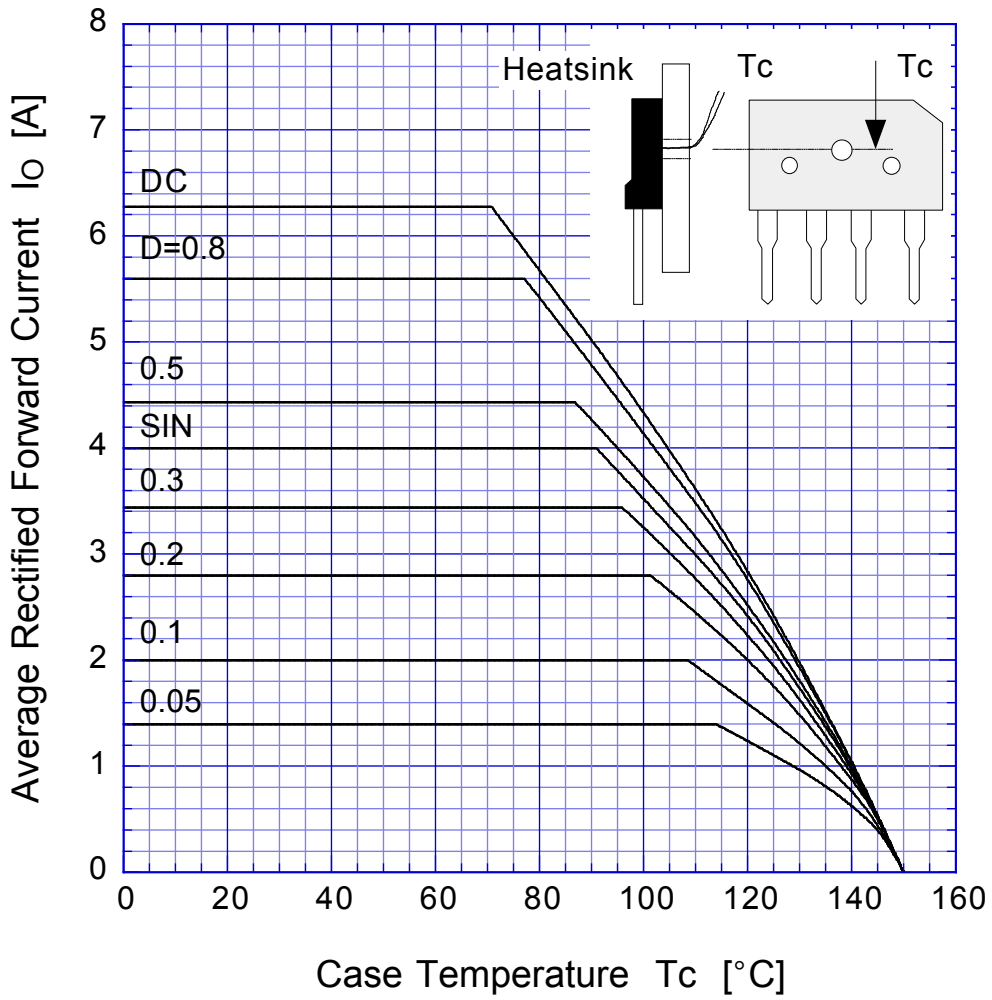

$$V_R = V_{RM}$$



D4SBL40

Derating Curve

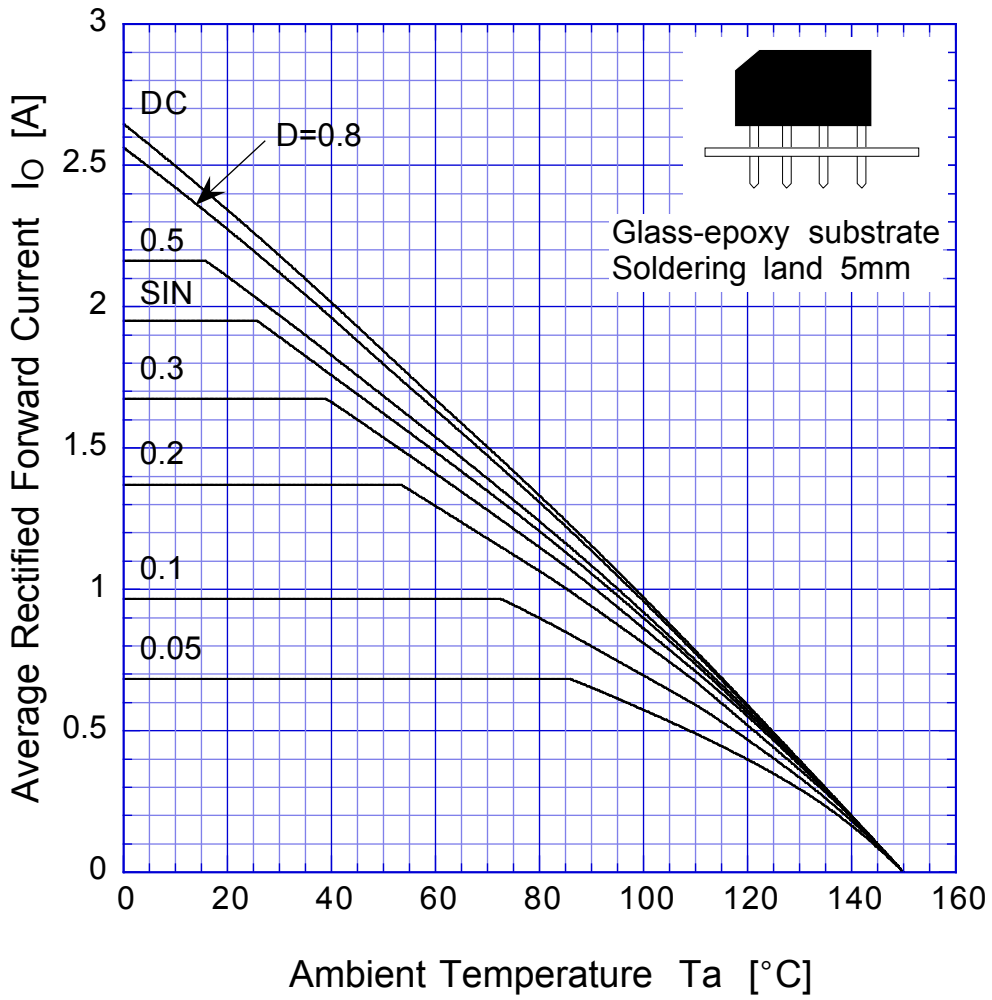

$V_R = V_{RM}$
Sine wave
R-load
Free in air

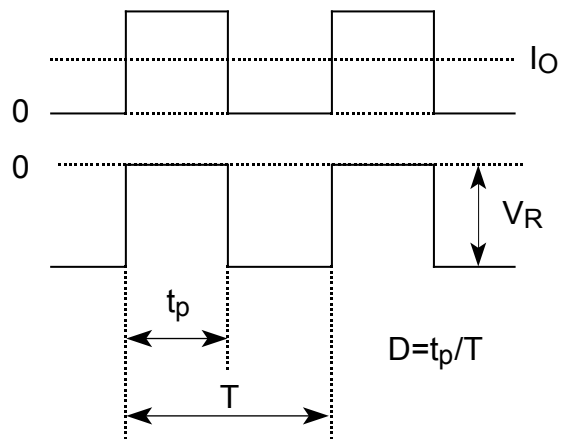

D4SBL40

Peak Surge Forward Capability

