



1.0 Hz to 100 kHz
Fixed Frequency

32 Pin DIP
8-Pole Filters

Description

The D78 and DP78 Series of low-power, fixed-frequency, linear active filters are high performance, 8-pole filters in a compact package. These Butterworth and Bessel low-pass and Butterworth high-pass filters (D78 only) combine linear active filter design with the space savings of a 32-pin dual in-line package (DIP). Each model comes factory tuned to a user-specified corner frequency between 1 Hz and 100 kHz (DP78, 1 Hz to 5kHz). These fully self-contained units require no external components or adjustments and operate with dynamic input voltage range from non-critical $\pm 5V$ to $\pm 18V$ power supplies.

Features/Benefits:

- Low cost solution for low frequency signal conditioning
- Compact DIP design minimizes board space requirements
- Plug-in ready-to-use, reducing engineering design and manufacturing time
- Factory tuned, no external clocks or adjustments needed saving time and labor of other discrete assembly solutions
- Low harmonic distortion and wide signal-to-noise ratio to 12 bit resolution

Applications

- Anti-alias filtering
- Vibration & shock analysis
- Automatic test equipment
- Aerospace, navigation and sonar
- Communication systems
- Medical electronics
- Sound and vibration testing
- Noise elimination
- Process control



Available Low-Pass Models:

D78L8B	8-pole Butterworth2
DP78L8B	8-pole Butterworth (Low Power)2
D78L8L	8-pole Bessel2
DP78L8L	8-pole Bessel (Low Power)2

Available High-Pass Models:

D78H8B	8-pole Butterworth2
---------------	------------------------------	----

General Specifications:

Pin-out/package data & ordering information3
---	----



Fixed Frequency

8-Pole Low-Pass and High-Pass Filters

Model	D78L8B & DP78L8B	D78L8L & DP78L8L	Model	D78H8B
Product Specifications	Low-Pass		High-Pass	
Transfer Function	8-Pole, Butterworth		Transfer Function	8-Pole, Butterworth,
Size			Size	
D78 1.00 Hz to 1.00 kHz	1.8" x 0.8" x 0.5"	1.8" x 0.8" x 0.5"	D78 1.00 Hz to 1.00 kHz	1.8" x 0.8" x 0.5"
D78 1.01 kHz to 100 kHz	1.8" x 0.8" x 0.3"	1.8" x 0.8" x 0.3"	D78 1.01 kHz to 100 kHz	1.8" x 0.8" x 0.3"
DP78 1.00 Hz to 5.00 kHz	1.8" x 0.8" x 0.5"	1.8" x 0.8" x 0.5"		
Range f_c			Range f_c	
D78	1 Hz to 100 kHz	1 Hz to 100 kHz	D78	1 Hz to 100 kHz
DP78	1 Hz to 5 kHz	1 Hz to 5 kHz		
Theoretical Transfer Characteristics	Appendix A Page 9	Appendix A Page 4	Theoretical Transfer Characteristics	Appendix A Page 29
Passband Ripple (theoretical)	0.0 dB		Passband Ripple (theoretical)	0.0 dB
DC Voltage Gain (non-inverting)	0 ± 0.1 dB typ.		Voltage Gain (non-inverting)	0 ± 0.1 dB to 100 kHz
Stopband Attenuation Rate	48 dB/octave		Stopband Attenuation Rate	48 dB/octave
Power Bandwidth			Power Bandwidth	120 kHz
Small Signal Bandwidth			Small Signal Bandwidth	(-6 dB) 1 MHz
Cutoff Frequency Stability	f _c ± 2% max.	f _c ± 2% max.	Cutoff Frequency Stability	f _c ± 2% max.
Amplitude	± 0.03% /°C	± 0.03% /°C	Amplitude	± 0.03% /°C
Phase	-3 dB -360°	-3 dB -182°	Phase	-3 dB -360°
Filter Attenuation (theoretical)	0.12 dB 0.80 f _c 3.01 dB 1.00 f _c 60.0 dB 2.37 f _c 80.0 dB 3.16 f _c	1.91 dB 0.80 f _c 3.01 dB 1.00 f _c 60.0 dB 4.52 f _c 80.0 dB 6.07 f _c	Filter Attenuation (theoretical)	80 dB .31 f _c 60 dB .42 f _c 3.01 dB 1.00 f _c 0.00 dB 2.0 f _c
Total Harmonic Distortion @ 1 kHz			Total Harmonic Distortion @ 1 kHz	
D78	<-70 dB		D78	<-70 dB
DP78	<-70 dB			
Wide Band Noise (5 Hz - 2 MHz)	200 μVrms typ.		Wide Band Noise (5 Hz - 2 MHz)	400 μVrms typ.
Narrow Band Noise (20 Hz - 100 kHz)	50 μVrms typ.		Narrow Band Noise (20 Hz - 100 kHz)	100 μVrms typ.
Filter Mounting Assembly	FMA-01A		Filter Mounting Assembly	FMA-01A



Specification

(25°C and Vs ± 15 Vdc)

Pin-Out and Package Data Ordering Information

Analog Input Characteristics¹

Impedance	10 kΩ min.
Voltage Range	± 10 Vpeak
Max. Safe Voltage	± Vs

Analog Output Characteristics

Impedance	1 Ω
Linear Operating Range	± 10 V
Maximum Current ²	
D78	± 10 mA
DP78	± 5 mA
Offset Voltage	20 mV max. 3 mV typ.
Offset Temp. Coeff.	20 μV / °C typ.

Power Supply (±V)

Rated Voltage	± 15 Vdc
Operating Range	± 5 to ± 18 Vdc
Maximum Safe Voltage	± 18 Vdc
Quiescent Current D78	

12 mA max.
8 mA typ.

Quiescent Current **DP78**

2.5 mA max.
1.5 mA typ.

Temperature

Operating	0 to + 70 °C
Storage	- 25 to + 85 °C

Notes:

1. Input and output signal voltage referenced to supply common.
2. Output is short circuit protected to common.
DO NOT CONNECT TO ±Vs.

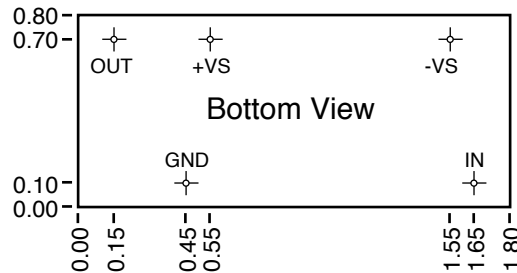
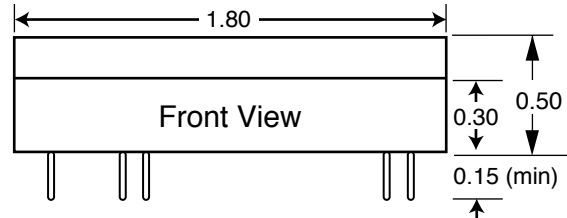
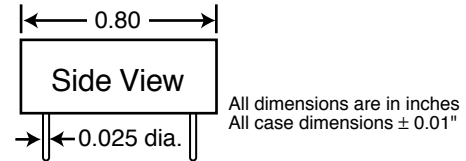

Filter Mounting Assembly-See FMA-01A

Ordering Information

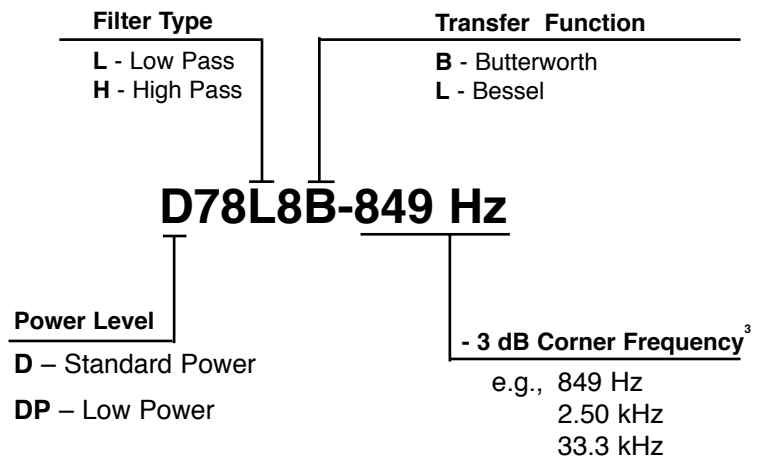

3. How to Specify Corner Frequency:

Corner frequencies are specified by attaching a three digit frequency designator to the basic model number. Corner frequencies can range from 1 Hz to 100 kHz.



Appendix A

Theoretical Transfer Characteristics

f/fc (Hz)	Amp (dB)	Phase (deg)	Delay ¹ (sec)
0.00	0.00	0.00	.506
0.10	-0.029	-18.2	.506
0.20	-0.117	-36.4	.506
0.30	-0.264	-54.7	.506
0.40	-0.470	-72.9	.506
0.50	-0.737	-91.1	.506
0.60	-1.06	-109	.506
0.70	-1.45	-128	.506
0.80	-1.91	-146	.506
0.85	-2.16	-155	.506
0.90	-2.42	-164	.506
0.95	-2.71	-173	.506
1.00	-3.01	-182	.506
1.10	-3.67	-200	.506
1.20	-4.40	-219	.506
1.30	-5.20	-237	.506
1.40	-6.10	-255	.505
1.50	-7.08	-273	.504
1.60	-8.16	-291	.502
1.70	-9.36	-309	.498
1.80	-10.7	-327	.492
1.90	-12.1	-345	.482
2.00	-13.7	-362	.468
2.25	-18.1	-402	.417
2.50	-23.1	-436	.352
2.75	-28.3	-465	.291
3.00	-33.4	-489	.241
3.25	-38.3	-509	.201
3.50	-43.1	-526	.170
4.00	-51.8	-552	.126
5.00	-66.8	-587	.077
6.00	-79.2	-610	.052
7.00	-89.8	-626	.038
8.00	-99.0	-638	.029
9.00	-107	-647	.023
10.0	-114	-655	.018

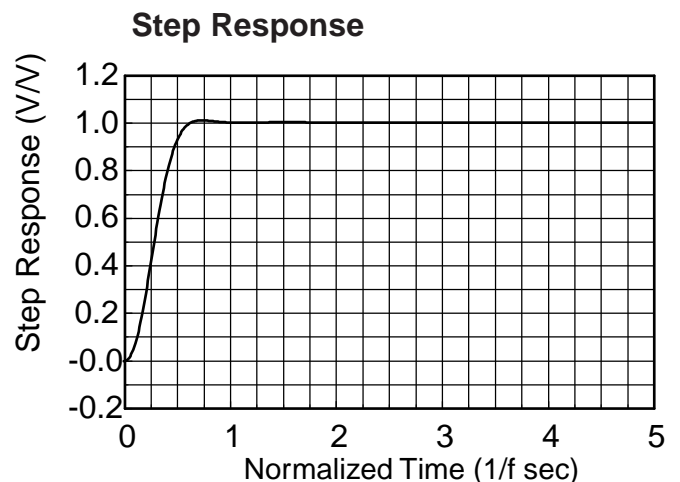
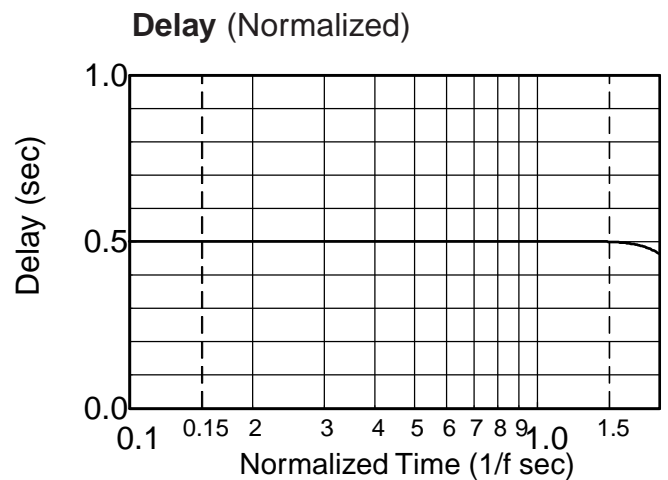
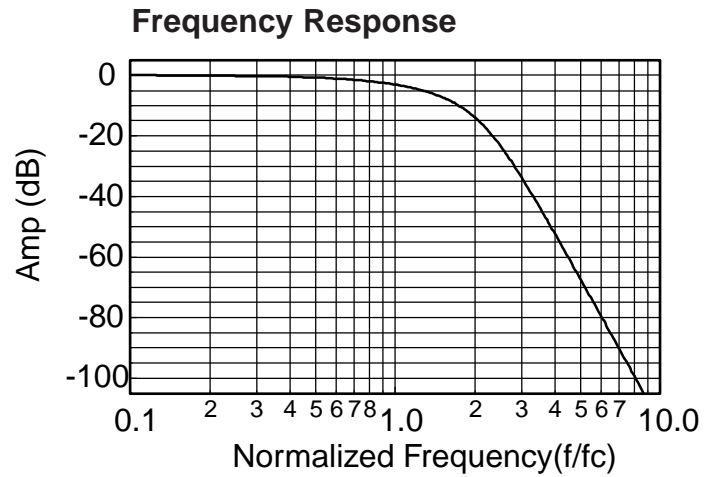

1. Normalized Group Delay:

The above delay data is normalized to a corner frequency of 1.0Hz. The actual delay is the normalized delay divided by the actual corner frequency (fc).

$$\text{Actual Delay} = \frac{\text{Normalized Delay}}{\text{Actual Corner Frequency (fc) in Hz}}$$



Appendix A

Theoretical Transfer Characteristics

f/fc (Hz)	Amp (dB)	Phase (deg)	Delay ¹ (sec)
0.00	0.00	0.00	.816
0.10	0.00	-29.4	.819
0.20	0.00	-59.0	.828
0.30	0.00	-89.1	.843
0.40	0.00	-120	.867
0.50	0.00	-152	.903
0.60	-0.001	-185	.956
0.70	-0.014	-221	1.04
0.80	-0.121	-261	1.19
0.85	-0.311	-283	1.29
0.90	-0.738	-307	1.40
0.95	-1.58	-333	1.48
1.00	-3.01	-360	1.46
1.10	-7.48	-408	1.17
1.20	-12.9	-445	.873
1.30	-18.2	-472	.672
1.40	-23.4	-494	.540
1.50	-28.2	-511	.448
1.60	-32.7	-526	.380
1.70	-36.9	-539	.328
1.80	-40.8	-550	.287
1.90	-44.6	-560	.253
2.00	-48.2	-568	.226
2.25	-56.3	-586	.174
2.50	-63.7	-600	.139
2.75	-70.3	-611	.113
3.00	-76.3	-621	.094
3.25	-81.9	-629	.080
3.50	-87.1	-635	.069
4.00	-96.3	-646	.052
5.00	-112	-661	.033
6.00	-125	-671	.023
7.00	-135	-678	.017
8.00	-144	-683	.013
9.00	-153	-687	.010
10.0	-160	-691	.008

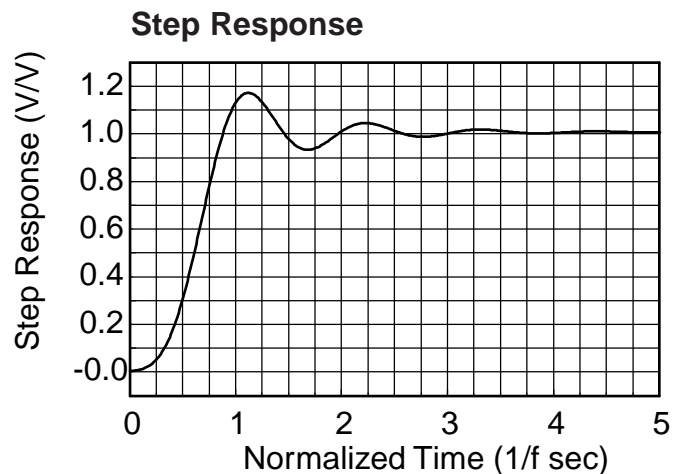
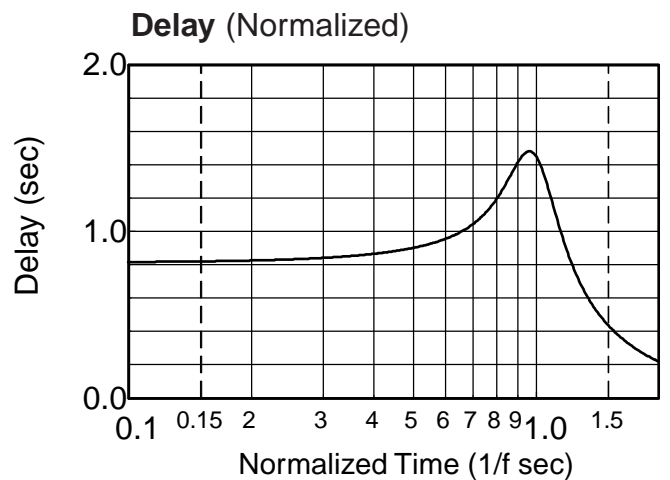
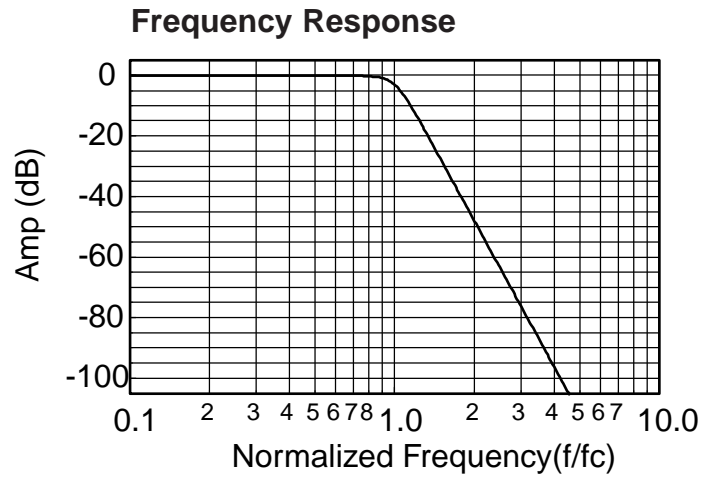

1. Normalized Group Delay:

The above delay data is normalized to a corner frequency of 1.0Hz. The actual delay is the normalized delay divided by the actual corner frequency (fc).

$$\text{Actual Delay} = \frac{\text{Normalized Delay}}{\text{Actual Corner Frequency (fc) in Hz}}$$



Theoretical Transfer Characteristics

f/fc (Hz)	Amp (dB)	Phase (deg)	Delay¹ (sec)
0.10	-160	691	0.819
0.20	-112	661	0.828
0.30	-83.7	631	0.843
0.40	-63.7	600	0.867
0.50	-48.2	568	0.903
0.60	-35.5	535	.956
0.70	-24.8	499	1.04
0.80	-15.6	459	1.19
0.85	-11.6	437	1.29
0.90	-8.06	413	1.40
0.95	-5.15	386	1.48
1.00	-3.01	360	1.46
1.20	-0.229	275	0.873
1.40	-0.020	226	0.540
1.60	-0.002	194	0.380
1.80	0.00	170	0.287
2.00	0.00	152	0.226
2.50	0.00	120	0.139
3.00	0.00	99.2	0.094
4.00	0.00	74.0	0.052
5.00	0.00	59.0	0.033
6.00	0.00	49.0	0.023
7.00	0.00	42.1	0.017
8.00	0.00	36.8	0.013
9.00	0.00	32.7	0.010
10.0	0.00	29.4	0.008

Frequency Response

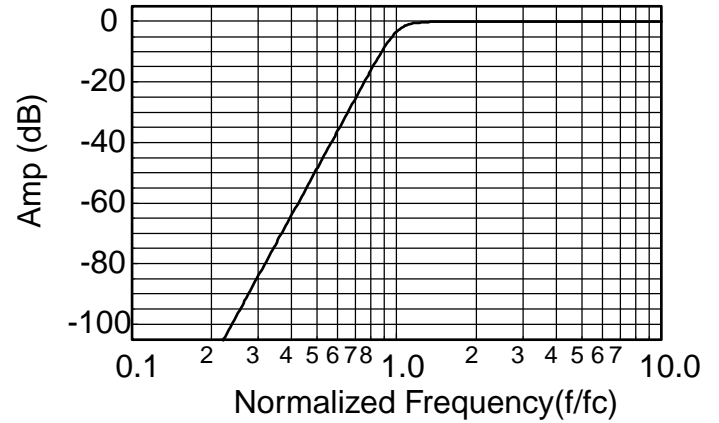

1. Normalized Group Delay:

The above delay data is normalized to a corner frequency of 1.0Hz. The actual delay is the normalized delay divided by the actual corner frequency (fc).

$$\text{Actual Delay} = \frac{\text{Normalized Delay}}{\text{Actual Corner Frequency (fc) in Hz}}$$