



## 16-Bit, Ultra-Low Glitch, Voltage Output DIGITAL-TO-ANALOG CONVERTER with 2.5V, 2ppm/°C Internal Reference

### FEATURES

- **Relative Accuracy: 4LSB**
- **Glitch Energy: 0.15nV-s**
- **MicroPower Operation: 510µA at 2.7V**
- **Internal Reference:**
  - **2.5V Reference Voltage (enabled by default)**
  - **0.02% Initial Accuracy**
  - **2ppm/°C Temperature Drift (typ)**
  - **5ppm/°C Temperature Drift (max)**
  - **20mA Sink/Source Capability**
- **Power-On Reset to Zero**
- **Power Supply: +2.7V to +5.5V**
- **16-Bit Monotonic Over Temperature Range**
- **Settling Time: 10µs to ±0.003% FSR**
- **Low-Power Serial Interface with Schmitt-Triggered Inputs**
- **On-Chip Output Buffer Amplifier with Rail-to-Rail Operation**
- **Power-Down Capability**
- **Drop-In Compatible With [DAC8531/01](#) and [DAC8550/51](#)**
- **Temperature Range: –40°C to +105°C**
- **Available in a Tiny MSOP-8 Package**

### APPLICATIONS

- **Process Control**
- **Data Acquisition Systems**
- **Closed-Loop Servo-Control**
- **PC Peripherals**
- **Portable Instrumentation**

### DESCRIPTION

The DAC8560 is a low-power, voltage output, 16-bit digital-to-analog converter (DAC). The DAC8560 includes a 2.5V, 2ppm/°C internal reference (enabled by default), giving a full-scale output voltage range of 2.5V. The internal reference has an initial accuracy of 0.02% and can source up to 20mA at the  $V_{REF}$  pin. The device is monotonic, provides very good linearity, and minimizes undesired code-to-code transient voltages (glitch). The DAC8560 uses a versatile 3-wire serial interface that operates at clock rates up to 30MHz. It is compatible with standard SPI™, QSPI™, Microwire™, and digital signal processor (DSP) interfaces.

The DAC8560 incorporates a power-on-reset circuit that ensures the DAC output powers up at zero-scale and remains there until a valid code is written to the device. The DAC8560 contains a power-down feature, accessed over the serial interface, that reduces the current consumption of the device to 1.2µA at 5V.

The low-power consumption, internal reference, and small footprint make this device ideal for portable, battery-operated equipment. The power consumption is 2.6mW at 5V, reducing to 6µW in power-down mode.

The DAC8560 is available in an MSOP-8 package.

### FUNCTIONAL BLOCK DIAGRAM

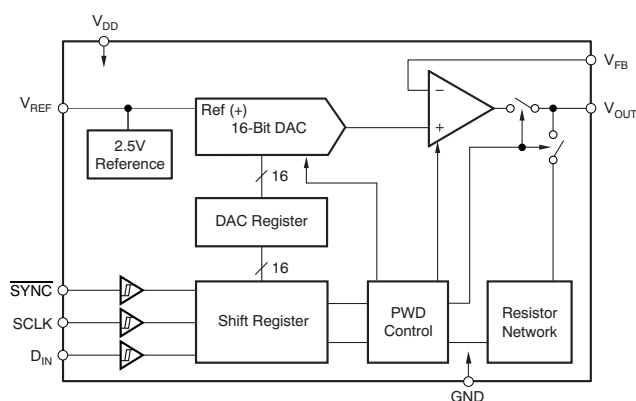

Please be aware that an important notice concerning availability, standard warranty, and use in critical applications of Texas Instruments semiconductor products and disclaimers thereto appears at the end of this data sheet.

SPI, QSPI are trademarks of Motorola, Inc.

Microwire is a trademark of National Semiconductor.

All other trademarks are the property of their respective owners.



This integrated circuit can be damaged by ESD. Texas Instruments recommends that all integrated circuits be handled with appropriate precautions. Failure to observe proper handling and installation procedures can cause damage.

ESD damage can range from subtle performance degradation to complete device failure. Precision integrated circuits may be more susceptible to damage because very small parametric changes could cause the device not to meet its published specifications.

**PACKAGING/ORDERING INFORMATION<sup>(1)</sup>**

PRODUCT	MAXIMUM RELATIVE ACCURACY (LSB)	MAXIMUM DIFFERENTIAL NONLINEARITY (LSB)	MAXIMUM REFERENCE DRIFT (ppm/°C)	PACKAGE-LEAD	PACKAGE DESIGNATOR	SPECIFIED TEMPERATURE RANGE	PACKAGE MARKING
DAC8560A	±12	±1	25	MSOP-8	DGK	–40°C TO +105°C	D860
DAC8560B	±8	±1	25				
DAC8560C	±12	±1	5				
DAC8560D	±8	±1	5				

(1) For the most current package and ordering information, see the Package Option Addendum at the end of this data sheet, or see the TI website at [www.ti.com](http://www.ti.com).

**ABSOLUTE MAXIMUM RATINGS<sup>(1)</sup>**

over operating free-air temperature range (unless otherwise noted)

	UNIT	
V <sub>DD</sub> to GND	–0.3V to 6V	
Digital input voltage to GND	–0.3V to +V <sub>DD</sub> + 0.3V	
V <sub>OUT</sub> to GND	–0.3V to +V <sub>DD</sub> + 0.3V	
Operating temperature range	–40°C to +105°C	
Storage temperature range	–65°C to +150°C	
Junction temperature range (T <sub>J</sub> max)	+150°C	
Power dissipation (DGK)	(T <sub>J</sub> max – T <sub>A</sub> )/θ <sub>JA</sub>	
Thermal impedance, θ <sub>JA</sub>	206°C/W	
Thermal impedance, θ <sub>JC</sub>	44°C/W	
ESD rating	Human body model (HBM)	4000V
	Charged device model (CDM)	1500V

(1) Stresses above those listed under *absolute maximum ratings* may cause permanent damage to the device. Exposure to absolute maximum conditions for extended periods may affect device reliability.

**ELECTRICAL CHARACTERISTICS**
 $V_{DD} = 2.7V$  to  $5.5V$ ,  $-40^{\circ}C$  to  $+105^{\circ}C$  range (unless otherwise noted)

PARAMETER	TEST CONDITIONS	MIN	TYP	MAX	UNIT	
<b>STATIC PERFORMANCE<sup>(1)</sup></b>						
Resolution		16			Bits	
Relative accuracy	Measured by line passing through codes 485 and 64714	DAC8560A, DAC8560C		$\pm 4$	$\pm 12$	LSB
		DAC8560B, DAC8560D		$\pm 4$	$\pm 8$	LSB
Differential nonlinearity	16-bit Monotonic		$\pm 0.5$	$\pm 1$	LSB	
Zero-code error	Measured by line passing through codes 485 and 64714.		$\pm 5$	$\pm 12$	mV	
Full-scale error			$\pm 0.2$	$\pm 0.5$	% of FSR	
Gain error			$\pm 0.05$	$\pm 0.2$	% of FSR	
Zero-code error drift				$\pm 20$	$\mu V/^{\circ}C$	
Gain temperature coefficient	$V_{DD} = 5V$		$\pm 1$		ppm of FSR/ $^{\circ}C$	
	$V_{DD} = 2.7V$		$\pm 3$			
PSRR Power supply rejection ratio	Output unloaded		1		mV/V	
<b>OUTPUT CHARACTERISTICS<sup>(2)</sup></b>						
Output voltage range		0		$V_{REF}$	V	
Output voltage settling time	To $\pm 0.003\%$ FSR, 0200h to FD00h, $R_L = 2k\Omega$ , $0pF < C_L < 200pF$ $R_L = 2k\Omega$ , $C_L = 500pF$		8	10	$\mu s$	
			12			
Slew rate			1.8		V/ $\mu s$	
Capacitive load stability	$R_L = \infty$		470		pF	
	$R_L = 2k\Omega$		1000			
Code change glitch impulse	1LSB change around major carry		0.15		nV-s	
Digital feedthrough	SCLK toggling, SYNC high		0.15		nV-s	
DC output impedance	At mid-code input		1		$\Omega$	
Short-circuit current	$V_{DD} = 5V$		50		mA	
	$V_{DD} = 3V$		20			
Power-up time	Coming out of power-down mode $V_{DD} = 5V$		2.5		$\mu s$	
	Coming out of power-down mode $V_{DD} = 3V$		5			
<b>AC PERFORMANCE<sup>(2)</sup></b>						
SNR	$T_A = +25^{\circ}C$ , BW = 20kHz, $V_{DD} = 5V$ , $f_{OUT} = 1kHz$ , 1st 19 harmonics removed for SNR calculation		88		dB	
THD			-77		dB	
SFDR			79		dB	
SINAD			77		dB	
DAC output noise density	$T_A = +25^{\circ}C$ , at mid-code input, $f_{OUT} = 1kHz$		170		nV/ $\sqrt{Hz}$	
DAC output noise	$T_A = +25^{\circ}C$ , at mid-code input, 0.1Hz to 10Hz		50		$\mu V_{PP}$	

(1) Linearity calculated using a reduced code range of 485 to 64714; output unloaded.

(2) Ensured by design and characterization, not production tested.

**ELECTRICAL CHARACTERISTICS (continued)**
 $V_{DD} = 2.7V$  to  $5.5V$ ,  $-40^{\circ}C$  to  $+105^{\circ}C$  range (unless otherwise noted)

PARAMETER	TEST CONDITIONS	MIN	TYP	MAX	UNIT
<b>REFERENCE OUTPUT</b>					
Output voltage	$T_A = +25^{\circ}C$	2.4995	2.5	2.5005	V
Initial accuracy	$T_A = +25^{\circ}C$	-0.02	$\pm 0.004$	0.02	%
Output voltage temperature drift	DAC8560A, DAC8560B <sup>(3)</sup>		5	25	ppm/ $^{\circ}C$
	DAC8560C, DAC8560D <sup>(4)</sup>		2	5	
Output voltage noise	$f = 0.1Hz$ to $10Hz$		16		$\mu V_{PP}$
Output voltage noise density (high-frequency noise)	$T_A = +25^{\circ}C$ , $f = 1MHz$ , $C_L = 0\mu F$		125		nV/ $\sqrt{Hz}$
	$T_A = +25^{\circ}C$ , $f = 1MHz$ , $C_L = 1\mu F$		20		
	$T_A = +25^{\circ}C$ , $f = 1MHz$ , $C_L = 4\mu F$		2		
Load regulation, sourcing <sup>(5)</sup>	$T_A = +25^{\circ}C$		30		$\mu V/mA$
Load regulation, sinking <sup>(5)</sup>	$T_A = +25^{\circ}C$		15		$\mu V/mA$
Output current load capability <sup>(6)</sup>			$\pm 20$		mA
Line regulation	$T_A = +25^{\circ}C$		10		$\mu V/V$
Long-term stability/drift (aging) <sup>(5)</sup>	$T_A = +25^{\circ}C$ , time = 0 to 1900 hours		50		ppm
Thermal hysteresis <sup>(5)</sup>	First cycle		100		ppm
	Additional cycles		25		
<b>REFERENCE</b>					
Internal reference current consumption	$V_{DD} = 5.5V$		360		$\mu A$
	$V_{DD} = 3.6V$		348		
External reference current	External $V_{REF} = 2.5V$ , if internal reference is disabled		20		$\mu A$
Reference input range		0		$V_{DD}$	V
Reference input impedance			125		k $\Omega$
<b>LOGIC INPUTS <sup>(6)</sup></b>					
Input current			$\pm 1$		$\mu A$
$V_{INL}$ Logic input LOW voltage	$V_{DD} = 5V$			0.8	V
	$V_{DD} = 3V$			0.6	
$V_{INH}$ Logic input HIGH voltage	$V_{DD} = 5V$	2.4			V
	$V_{DD} = 3V$	2.1			
Pin capacitance				3	pF
<b>POWER REQUIREMENTS</b>					
$V_{DD}$		2.7		5.5	V
$I_{DD}$ <sup>(7)</sup>	Normal mode	$V_{DD} = 3.6V$ to $5.5V$ , $V_{IH} = V_{DD}$ and $V_{IL} = GND$	0.530	0.850	mA
		$V_{DD} = 2.7V$ to $3.6V$ , $V_{IH} = V_{DD}$ and $V_{IL} = GND$	0.510	0.840	
	All power-down modes	$V_{DD} = 3.6V$ to $5.5V$ , $V_{IH} = V_{DD}$ and $V_{IL} = GND$	1.2	2.5	$\mu A$
		$V_{DD} = 2.7V$ to $3.6V$ , $V_{IH} = V_{DD}$ and $V_{IL} = GND$	0.7	2.2	
Power dissipation <sup>(7)</sup>	Normal mode	$V_{DD} = 3.6V$ to $5.5V$	2.6	4.7	mW
		$V_{DD} = 2.7V$ to $3.6V$	1.5	3.0	
	All power-down modes	$V_{DD} = 3.6V$ to $5.5V$	6	14	$\mu W$
		$V_{DD} = 2.7V$ to $3.6V$	2	8	
<b>TEMPERATURE RANGE</b>					
Specified performance		-40		+105	$^{\circ}C$

(3) Reference is trimmed and tested at room temperature, and is characterized from  $-40^{\circ}C$  to  $+120^{\circ}C$ .

(4) Reference is trimmed and tested at two temperatures ( $+25^{\circ}C$  and  $+105^{\circ}C$ ), and is characterized from  $-40^{\circ}C$  to  $+120^{\circ}C$ .

(5) Explained in more detail in the [Application Information](#) section of this data sheet.

(6) Ensured by design and characterization, not production tested.

(7) Input code = 32768, reference current included, no load.

## PIN CONFIGURATION

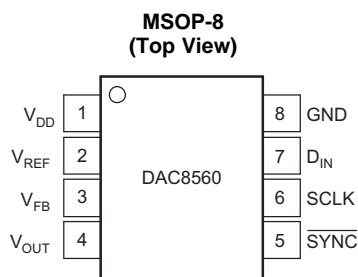

## PIN DESCRIPTIONS

PIN	NAME	DESCRIPTION
1	$V_{DD}$	Power supply input, 2.7V to 5.5V.
2	$V_{REF}$	Reference voltage input/output.
3	$V_{FB}$	Feedback connection for the output amplifier. For voltage output operation, tie to $V_{OUT}$ externally.
4	$V_{OUT}$	Analog output voltage from DAC. The output amplifier has rail-to-rail operation.
5	$\overline{SYNC}$	Level-triggered control input (active LOW). This is the frame synchronization signal for the input data. When $\overline{SYNC}$ goes LOW, it enables the input shift register, and data is sampled on subsequent falling clock edges. The DAC output updates following the 24th clock. If $\overline{SYNC}$ is taken HIGH before the 24th clock edge, the rising edge of $\overline{SYNC}$ acts as an interrupt, and the write sequence is ignored by the DAC8560. Schmitt-Trigger logic input.
6	SCLK	Serial clock input. Schmitt-Trigger logic input.
7	$D_{IN}$	Serial data input. Data is clocked into the 24-bit input shift register on each falling edge of the serial clock input. Schmitt-Trigger logic Input.
8	GND	Ground reference point for all circuitry on the part.

### SERIAL WRITE OPERATION

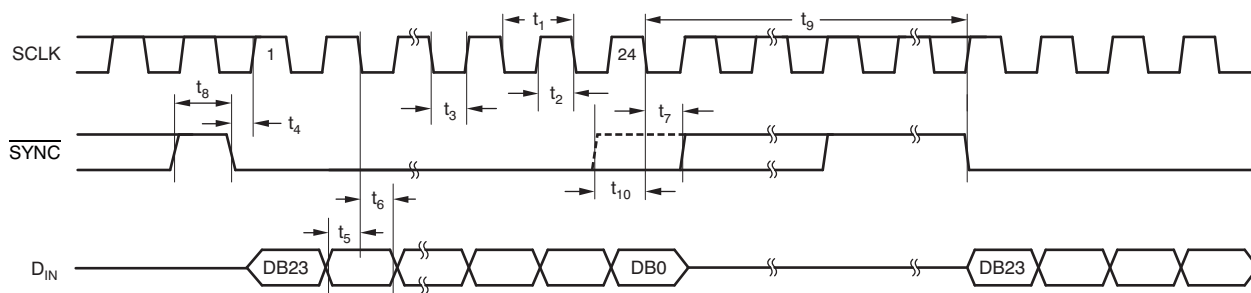

### TIMING REQUIREMENTS<sup>(1)(2)</sup>

V<sub>DD</sub> = 2.7V to 5.5V, all specifications –40°C to +105°C (unless otherwise noted)

PARAMETER		TEST CONDITIONS	MIN	TYP	MAX	UNIT
t <sub>1</sub> <sup>(3)</sup>	SCLK cycle time	V <sub>DD</sub> = 2.7V to 3.6V	50			ns
		V <sub>DD</sub> = 3.6V to 5.5V	33			
t <sub>2</sub>	SCLK HIGH time	V <sub>DD</sub> = 2.7V to 3.6V	13			ns
		V <sub>DD</sub> = 3.6V to 5.5V	13			
t <sub>3</sub>	SCLK LOW time	V <sub>DD</sub> = 2.7V to 3.6V	22.5			ns
		V <sub>DD</sub> = 3.6V to 5.5V	13			
t <sub>4</sub>	SYNC to SCLK rising edge setup time	V <sub>DD</sub> = 2.7V to 3.6V	0			ns
		V <sub>DD</sub> = 3.6V to 5.5V	0			
t <sub>5</sub>	Data setup time	V <sub>DD</sub> = 2.7V to 3.6V	5			ns
		V <sub>DD</sub> = 3.6V to 5.5V	5			
t <sub>6</sub>	Data hold time	V <sub>DD</sub> = 2.7V to 3.6V	4.5			ns
		V <sub>DD</sub> = 3.6V to 5.5V	4.5			
t <sub>7</sub>	SCLK falling edge to SYNC rising edge	V <sub>DD</sub> = 2.7V to 3.6V	0			ns
		V <sub>DD</sub> = 3.6V to 5.5V	0			
t <sub>8</sub>	Minimum SYNC HIGH time	V <sub>DD</sub> = 2.7V to 3.6V	50			ns
		V <sub>DD</sub> = 3.6V to 5.5V	33			
t <sub>9</sub>	24th SCLK falling edge to SYNC falling edge	V <sub>DD</sub> = 2.7V to 3.6V	100			ns
		V <sub>DD</sub> = 3.6V to 5.5V	100			
t <sub>10</sub>	SYNC rising edge to 24th SCLK falling edge (for successful SYNC interrupt)	V <sub>DD</sub> = 2.7V to 3.6V	15			ns
		V <sub>DD</sub> = 3.6V to 5.5V	15			

(1) All input signals are specified with t<sub>R</sub> = t<sub>F</sub> = 3ns (10% to 90% of V<sub>DD</sub>) and timed from a voltage level of (V<sub>IL</sub> + V<sub>IH</sub>)/2.

(2) See Serial Write Operation timing diagram.

(3) Maximum SCLK frequency is 30MHz at V<sub>DD</sub> = 3.6V to 5.5V and 20MHz at V<sub>DD</sub> = 2.7V to 3.6V.

**TYPICAL CHARACTERISTICS: Internal Reference**

At  $T_A = +25^\circ\text{C}$ , unless otherwise noted.

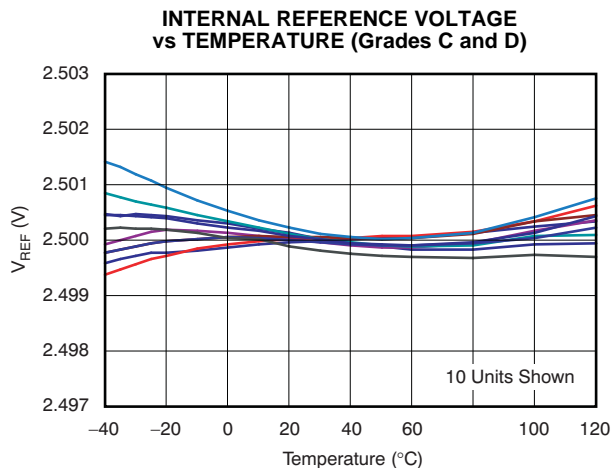

Figure 1.

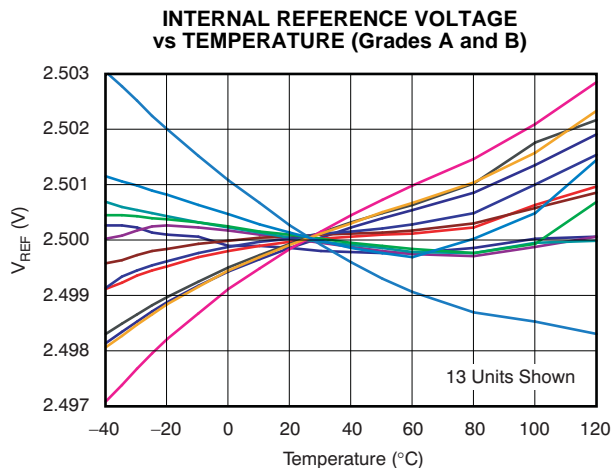

Figure 2.

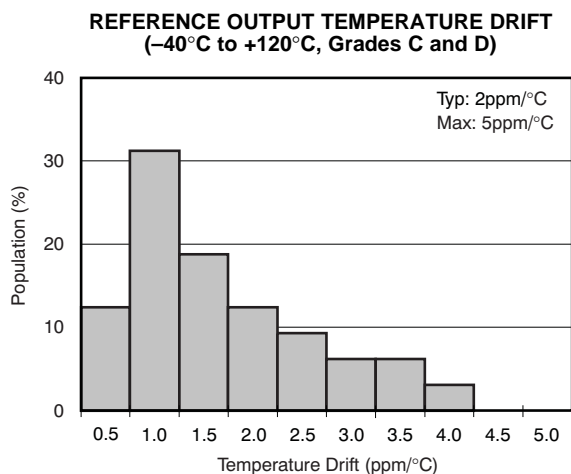

Figure 3.

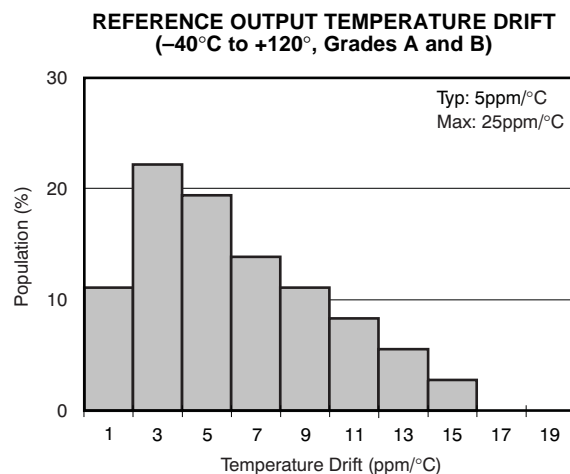

Figure 4.

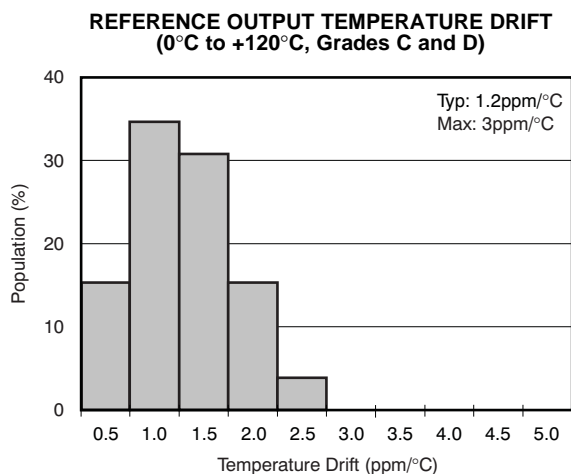

Figure 5.

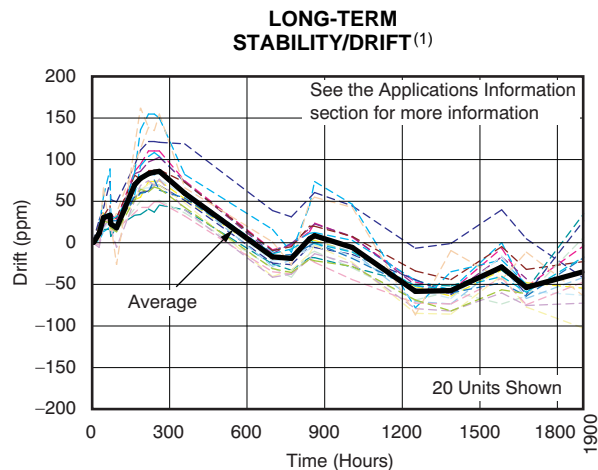

Figure 6.

(1) Explained in more detail in the [Application Information](#) section of this data sheet.

**TYPICAL CHARACTERISTICS: Internal Reference (continued)**

At  $T_A = +25^\circ\text{C}$ , unless otherwise noted.

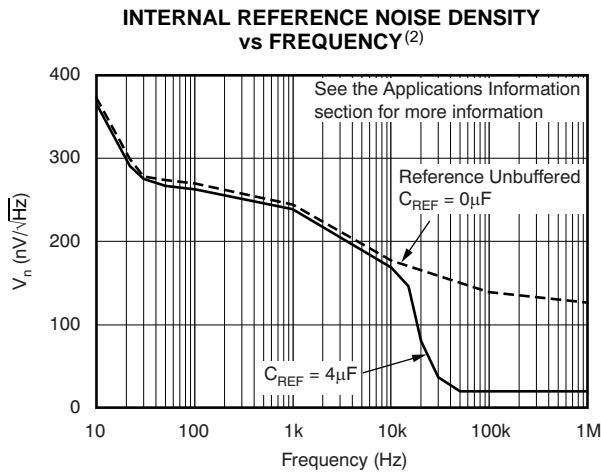

Figure 7.

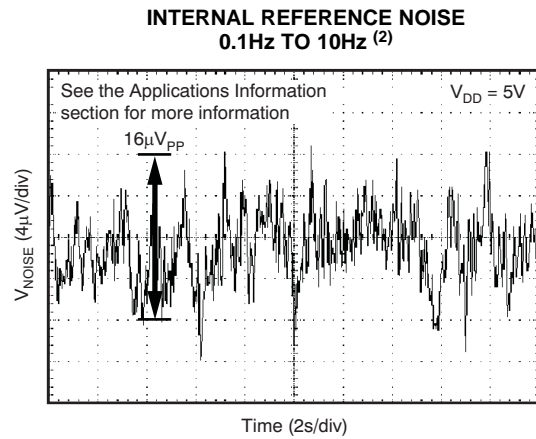

Figure 8.

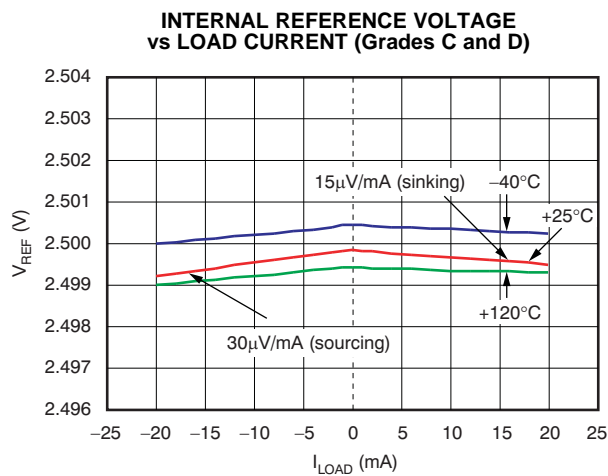

Figure 9.

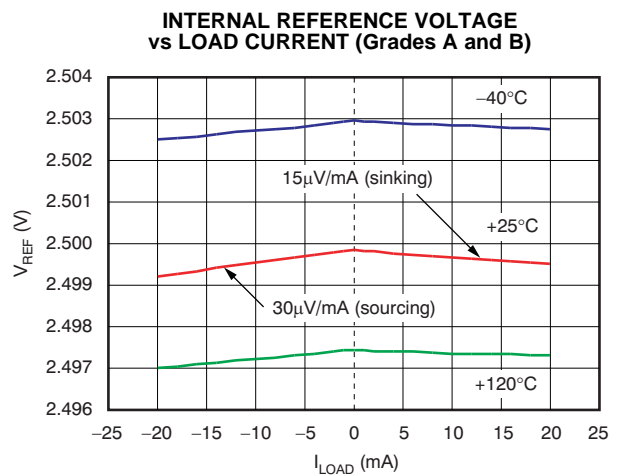

Figure 10.

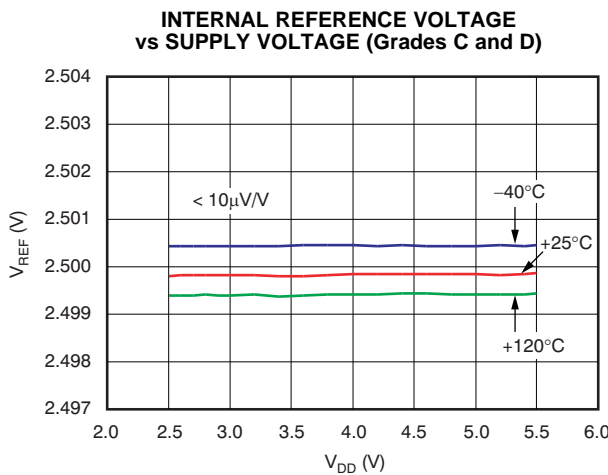

Figure 11.

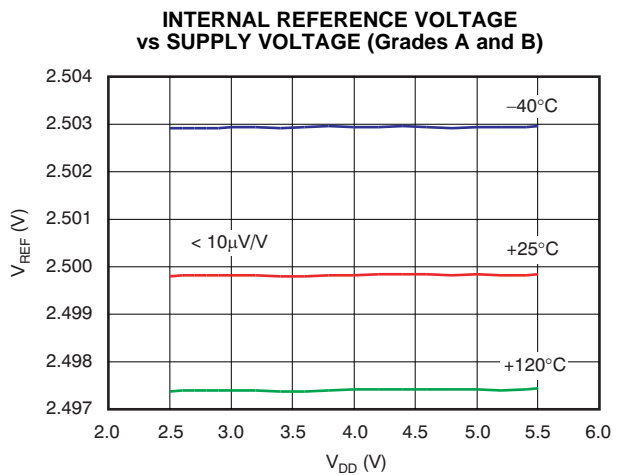

Figure 12.

(2) Explained in more detail in the [Application Information](#) section of this data sheet.



**TYPICAL CHARACTERISTICS: DAC at  $V_{DD} = 5V$**

At  $T_A = +25^\circ C$ , external reference used, and DAC output not loaded, unless otherwise noted.

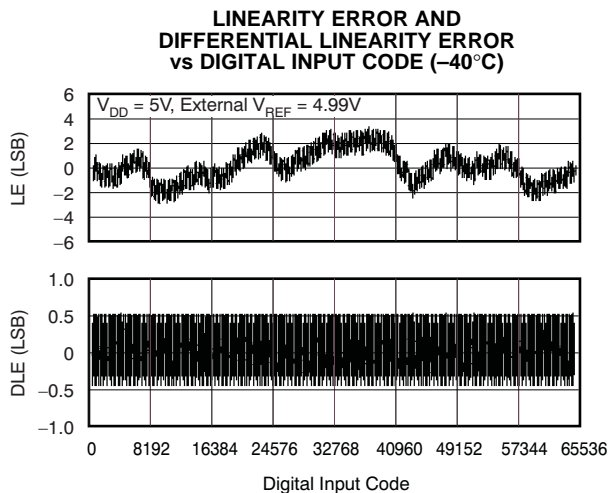

**Figure 13.**

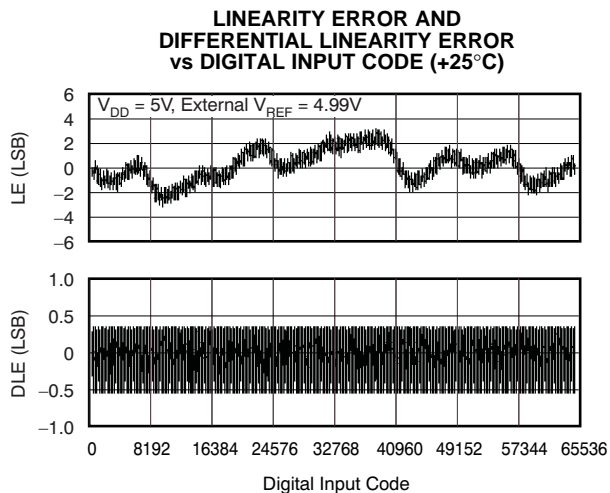

**Figure 14.**

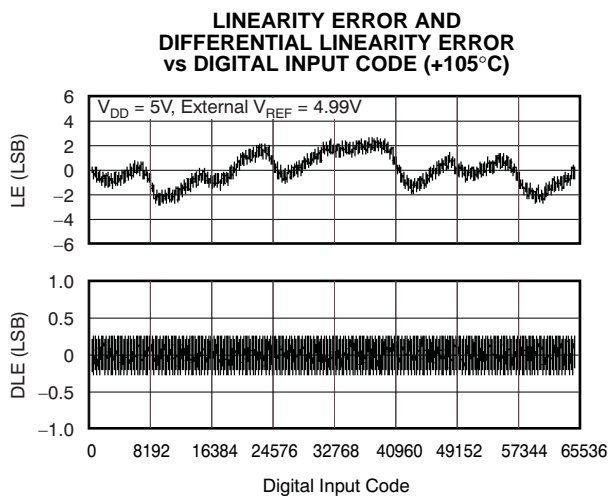

**Figure 15.**

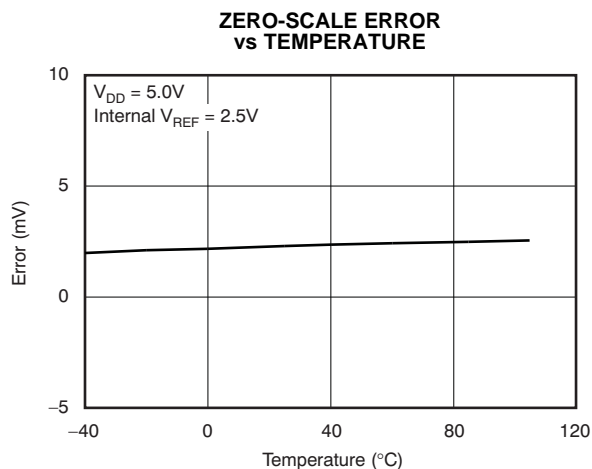

**Figure 16.**

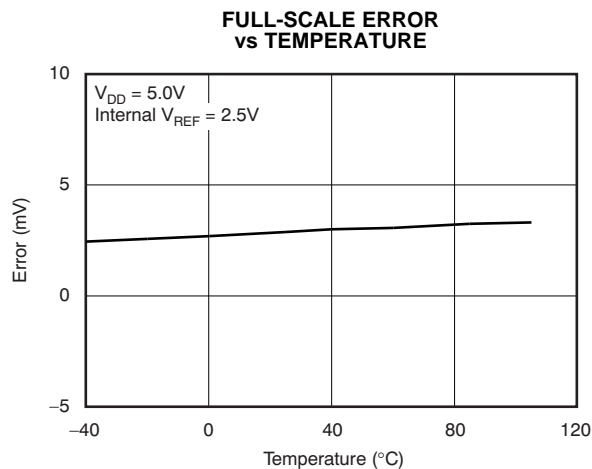

**Figure 17.**

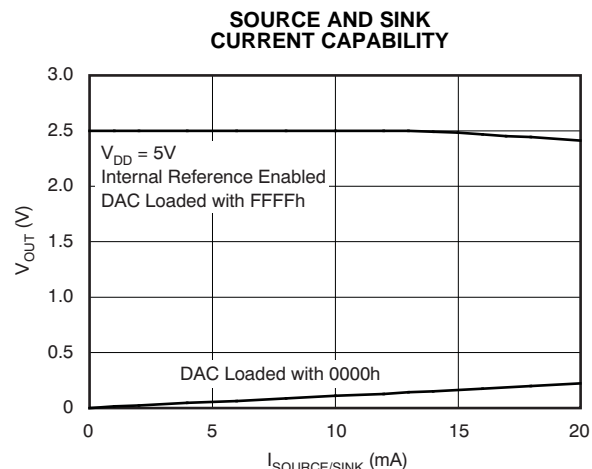

**Figure 18.**

**TYPICAL CHARACTERISTICS: DAC at  $V_{DD} = 5V$  (continued)**

At  $T_A = +25^\circ C$ , external reference used, and DAC output not loaded, unless otherwise noted.

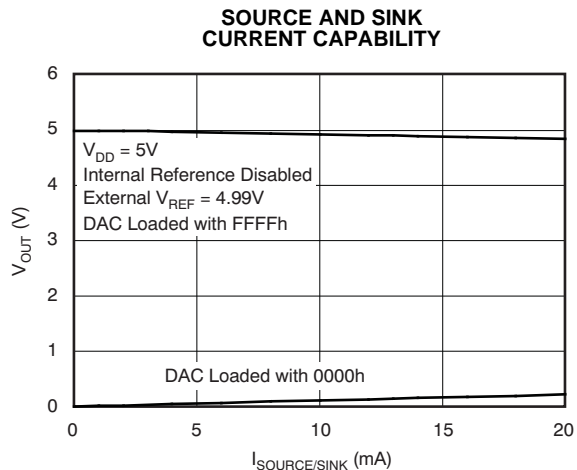

Figure 19.

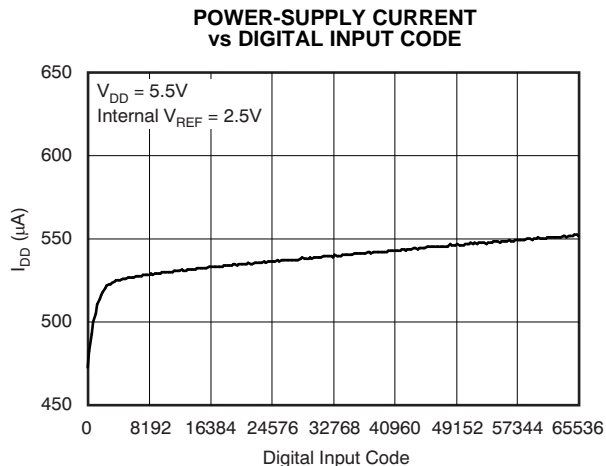

Figure 20.

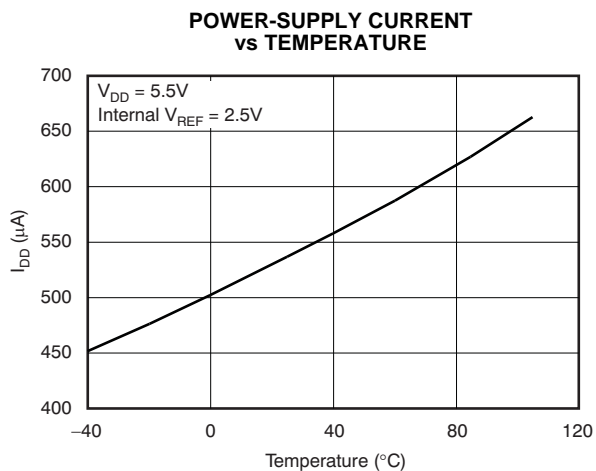

Figure 21.

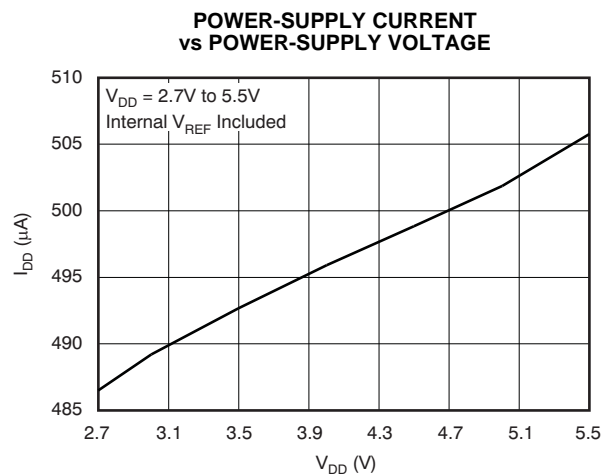

Figure 22.

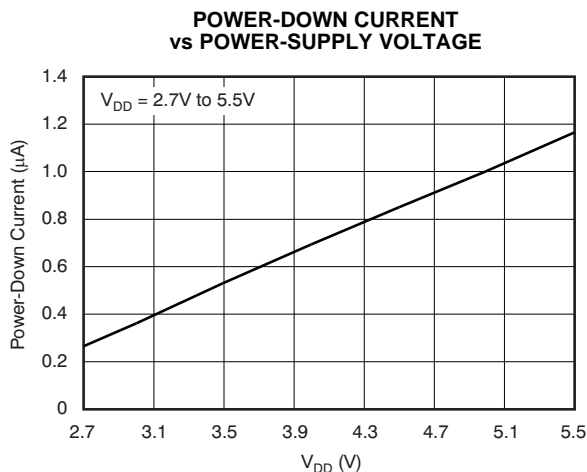

Figure 23.

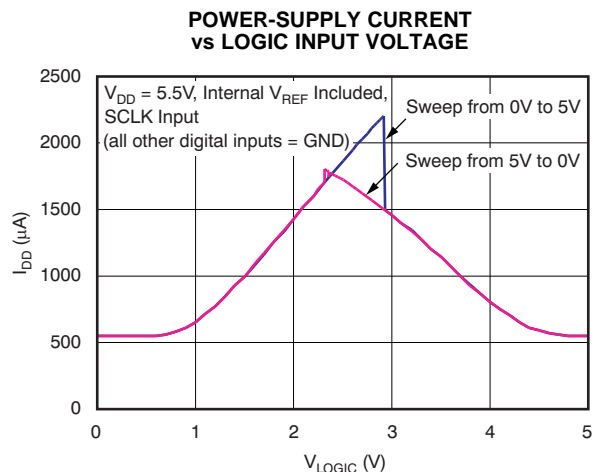
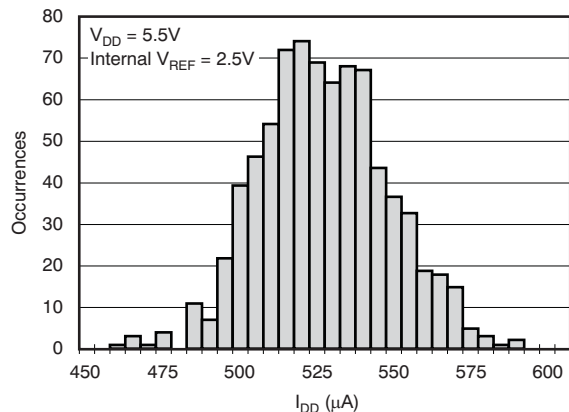

Figure 24.

**TYPICAL CHARACTERISTICS: DAC at  $V_{DD} = 5V$  (continued)**

At  $T_A = +25^\circ C$ , external reference used, and DAC output not loaded, unless otherwise noted.

**POWER-SUPPLY CURRENT HISTOGRAM**



**Figure 25.**

**TOTAL HARMONIC DISTORTION vs OUTPUT FREQUENCY**

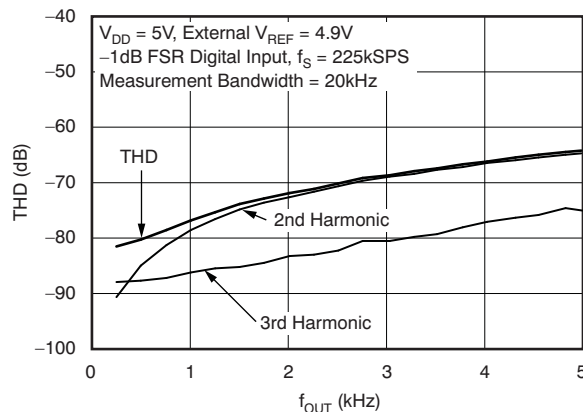

**Figure 26.**

**FULL-SCALE SETTLING TIME: 5V RISING EDGE**

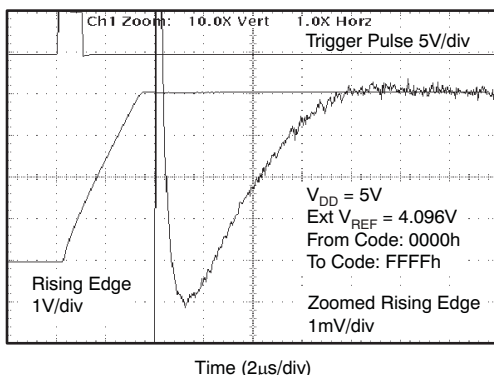

**Figure 27.**

**FULL-SCALE SETTLING TIME: 5V FALLING EDGE**

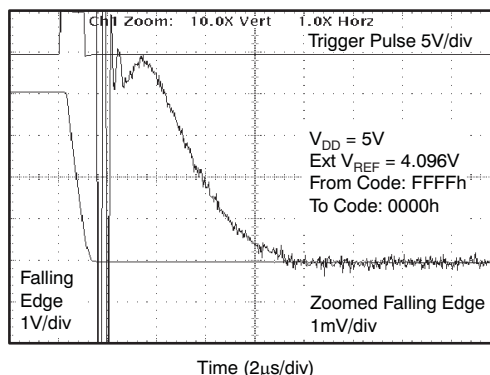

**Figure 28.**

**HALF-SCALE SETTLING TIME: 5V RISING EDGE**

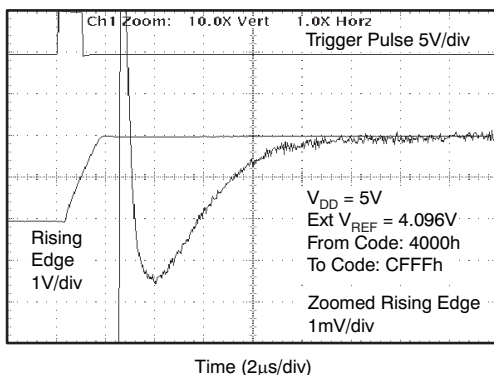

**Figure 29.**

**HALF-SCALE SETTLING TIME: 5V FALLING EDGE**

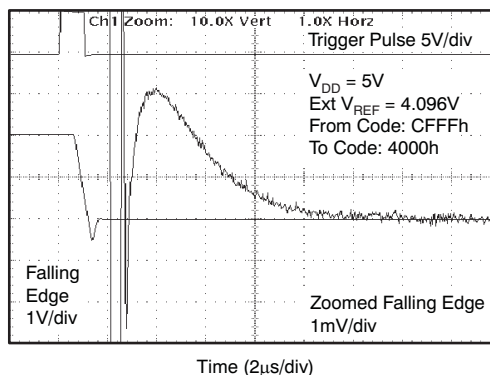

**Figure 30.**

**TYPICAL CHARACTERISTICS: DAC at  $V_{DD} = 5V$  (continued)**

At  $T_A = +25^\circ C$ , external reference used, and DAC output not loaded, unless otherwise noted.

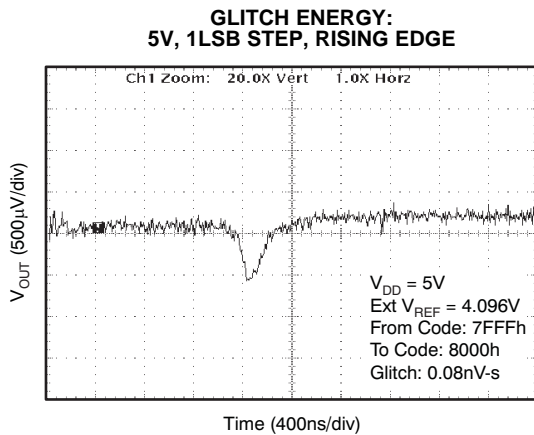

Figure 31.

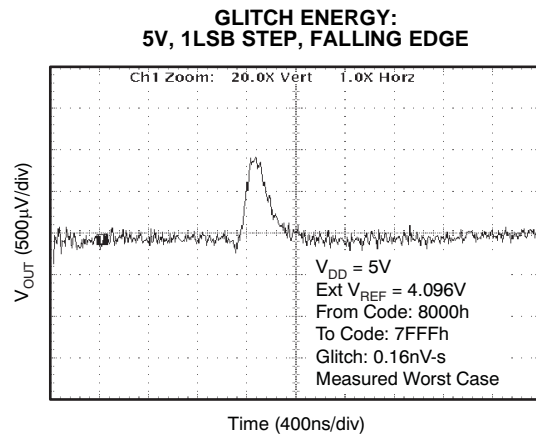

Figure 32.

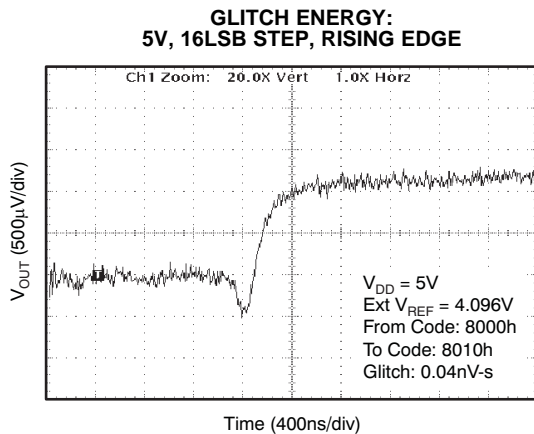

Figure 33.

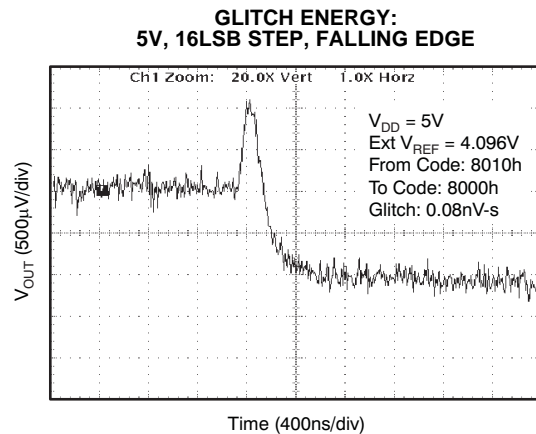

Figure 34.

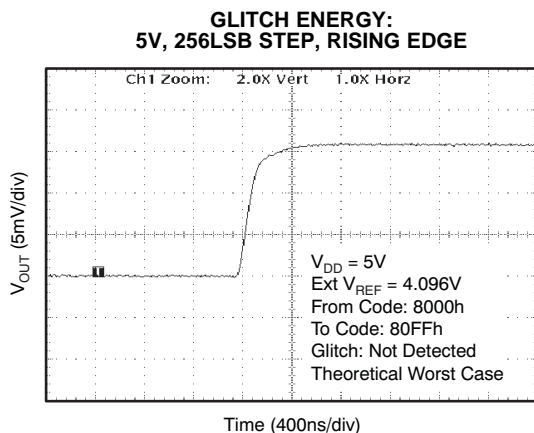

Figure 35.

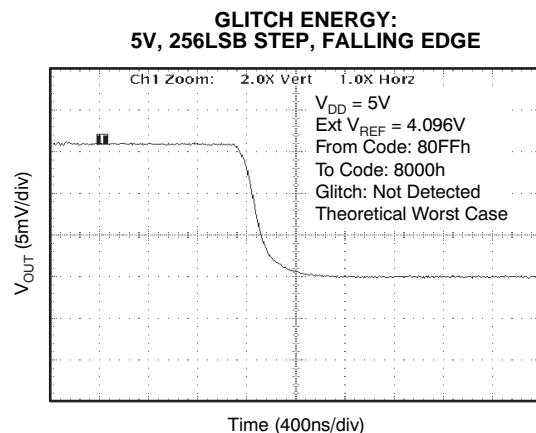

Figure 36.

**TYPICAL CHARACTERISTICS: DAC at  $V_{DD} = 5V$  (continued)**

At  $T_A = +25^\circ C$ , external reference used, and DAC output not loaded, unless otherwise noted.

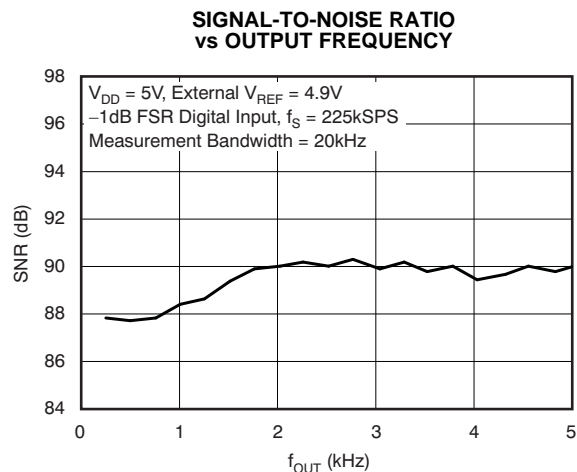

Figure 37.

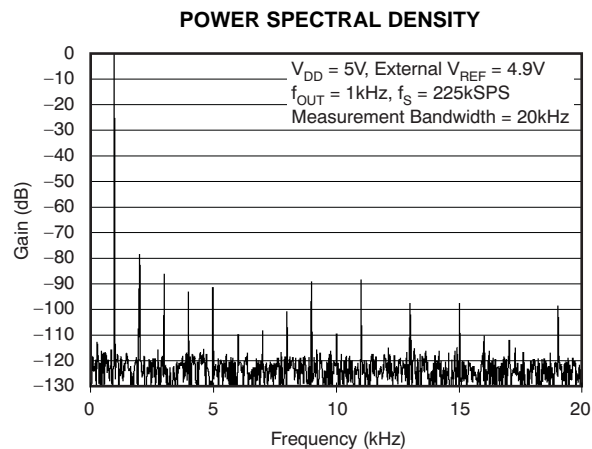

Figure 38.

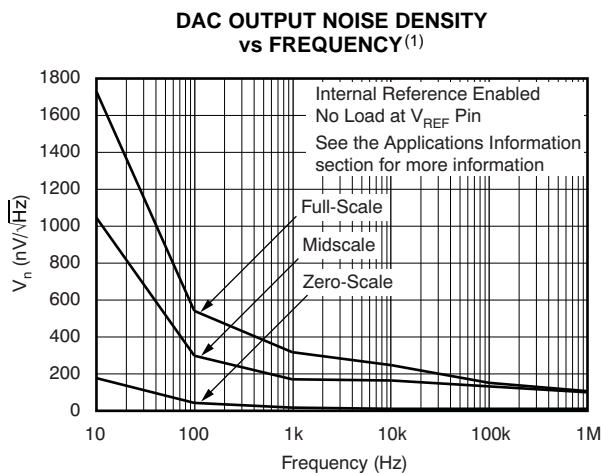

Figure 39.

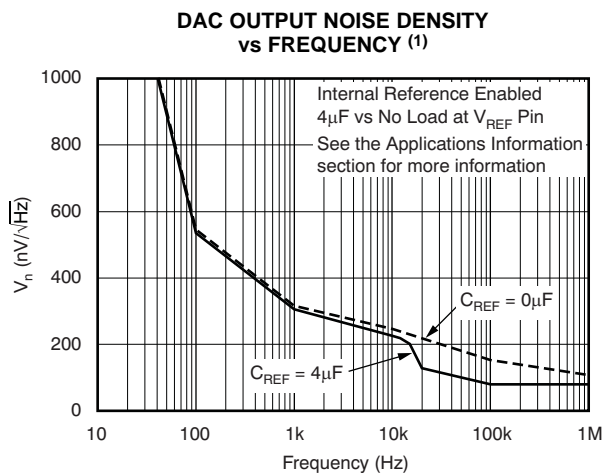

Figure 40.

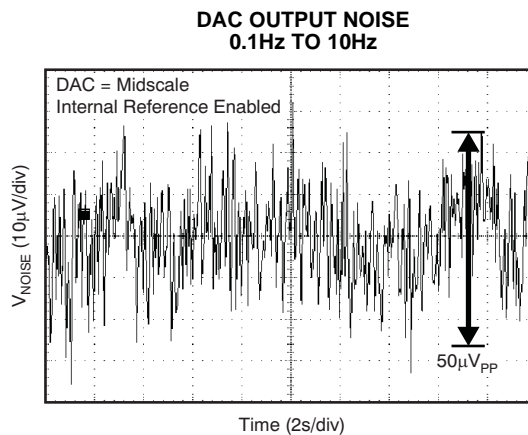

Figure 41.

(1) Explained in more detail in the [Application Information](#) section of this data sheet.

**TYPICAL CHARACTERISTICS: DAC at  $V_{DD} = 3.6V$**

At  $T_A = +25^\circ C$ , internal reference used, and DAC output not loaded, unless otherwise noted

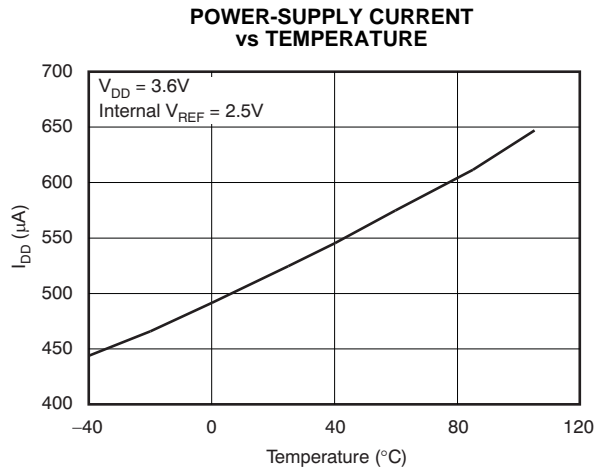

Figure 42.

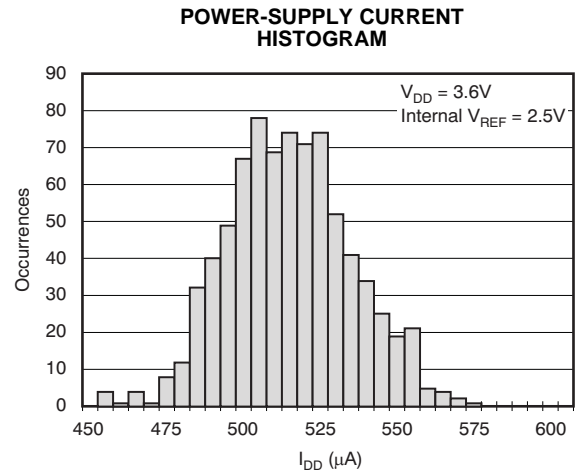
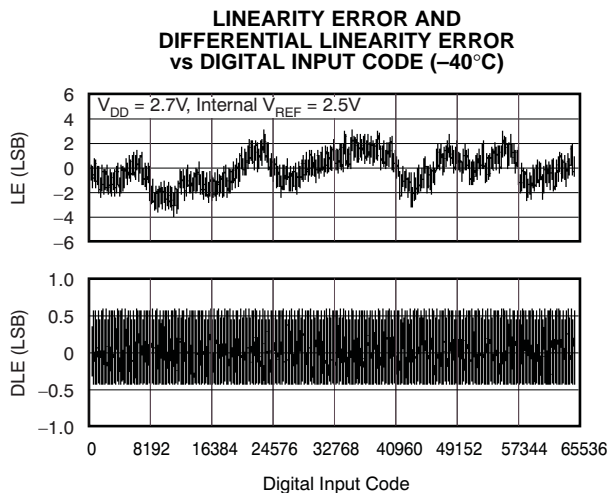

Figure 43.

**TYPICAL CHARACTERISTICS: DAC at  $V_{DD} = 2.7V$**

At  $T_A = +25^\circ C$ , internal reference used, and DAC output not loaded, unless otherwise noted



**Figure 44.**

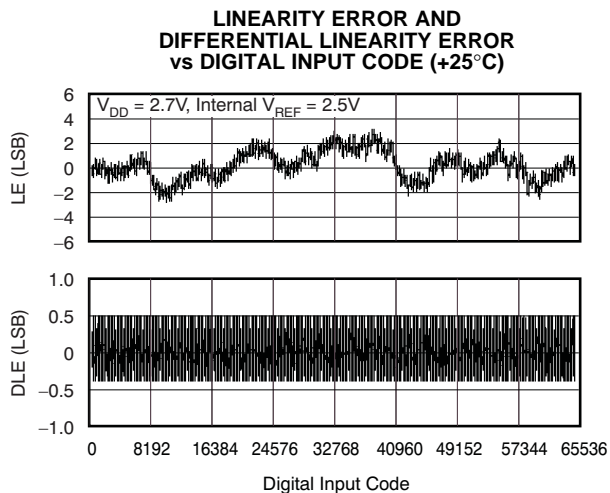

**Figure 45.**

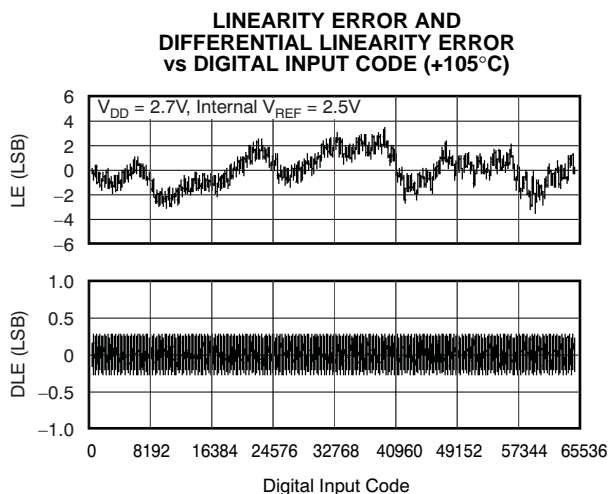

**Figure 46.**

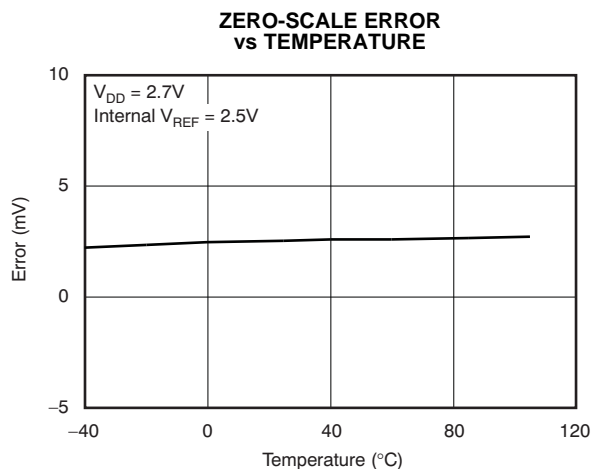

**Figure 47.**

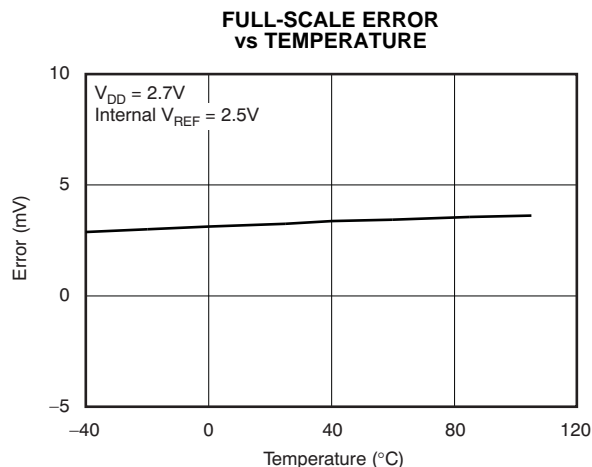

**Figure 48.**

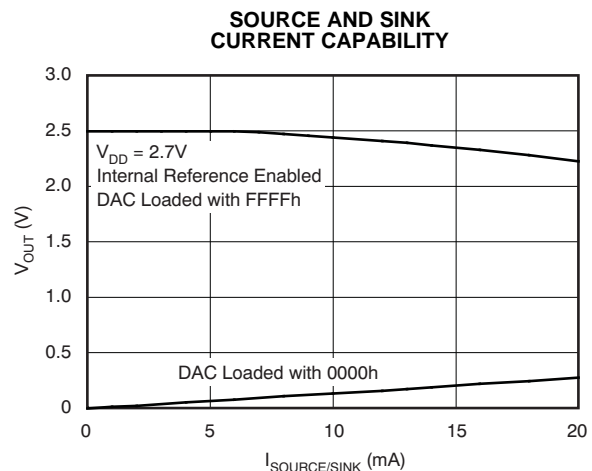
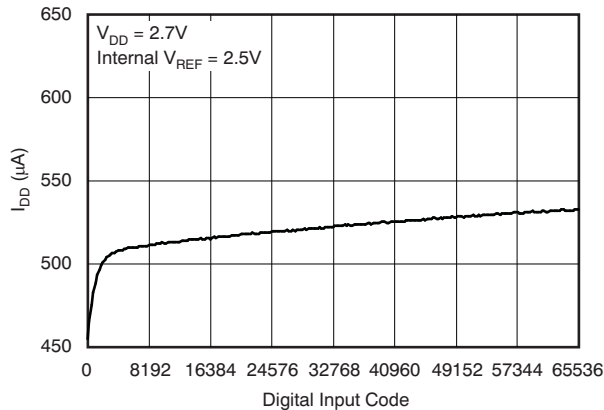

**Figure 49.**

**TYPICAL CHARACTERISTICS: DAC at  $V_{DD} = 2.7V$  (continued)**

At  $T_A = +25^\circ C$ , internal reference used, and DAC output not loaded, unless otherwise noted

**SUPPLY CURRENT vs DIGITAL INPUT CODE**



**Figure 50.**

**POWER-SUPPLY CURRENT vs LOGIC INPUT VOLTAGE**

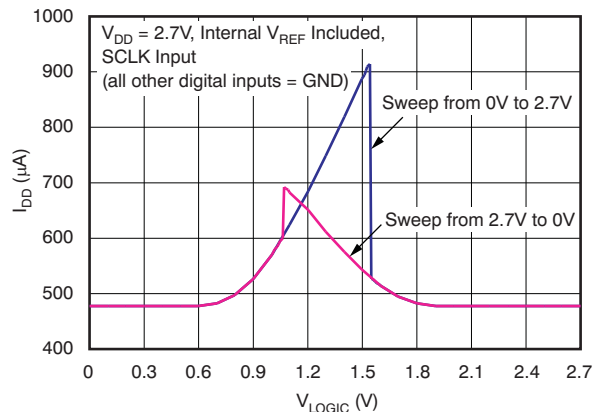

**Figure 51.**

**FULL-SCALE SETTLING TIME: 2.7V RISING EDGE**

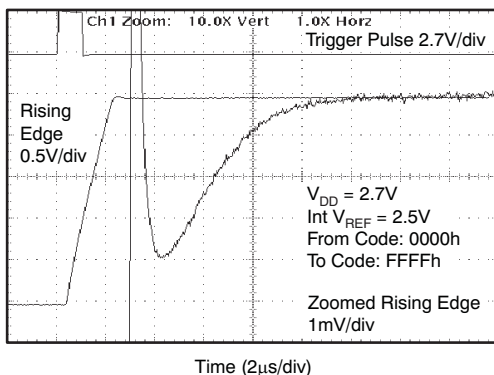

**Figure 52.**

**FULL-SCALE SETTLING TIME: 2.7V FALLING EDGE**

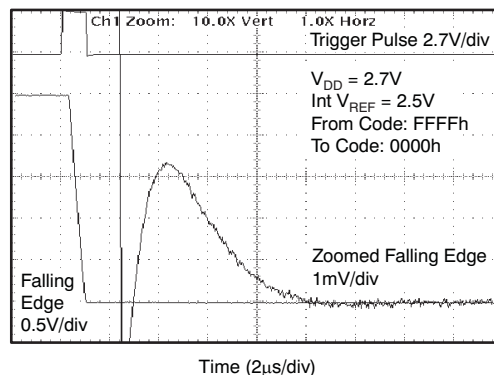

**Figure 53.**

**HALF-SCALE SETTLING TIME: 2.7V RISING EDGE**

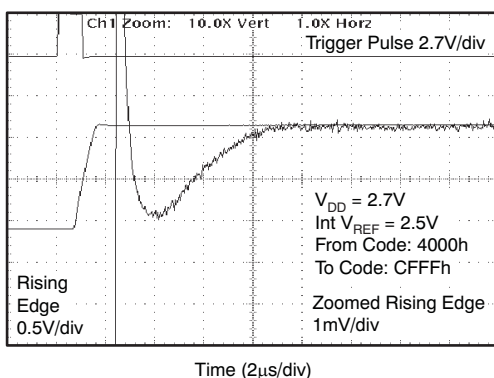

**Figure 54.**

**HALF-SCALE SETTLING TIME: 2.7V FALLING EDGE**

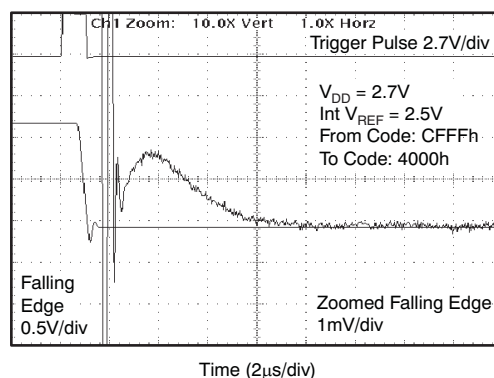

**Figure 55.**



**TYPICAL CHARACTERISTICS: DAC at  $V_{DD} = 2.7V$  (continued)**

At  $T_A = +25^\circ C$ , internal reference used, and DAC output not loaded, unless otherwise noted

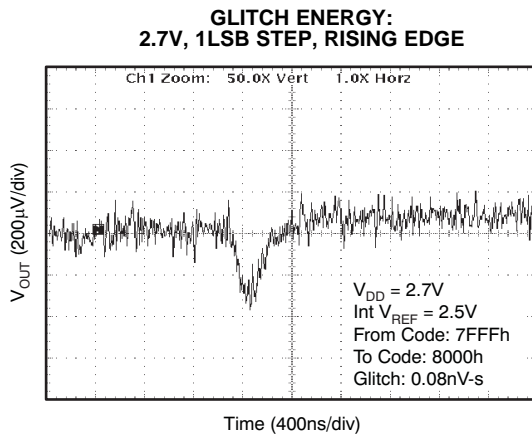

Figure 56.

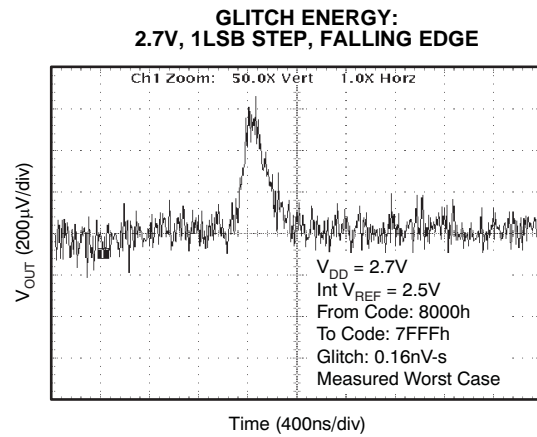

Figure 57.

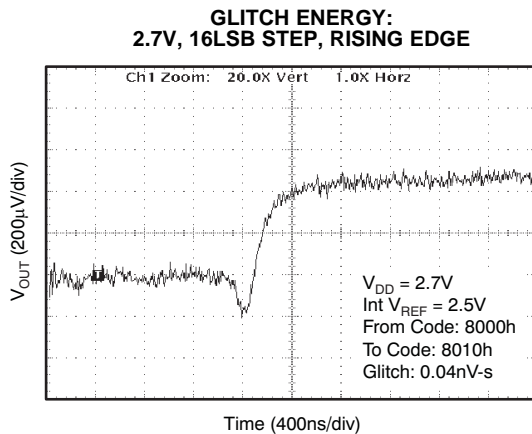

Figure 58.

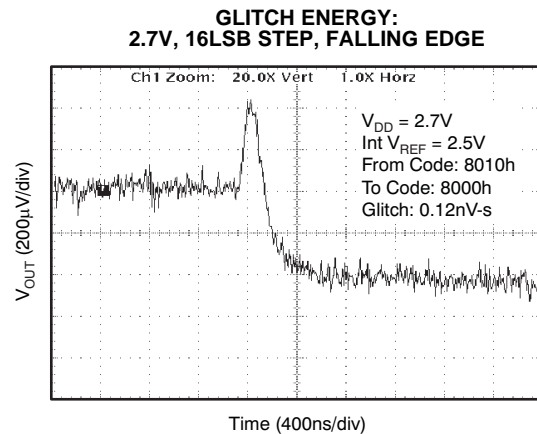

Figure 59.

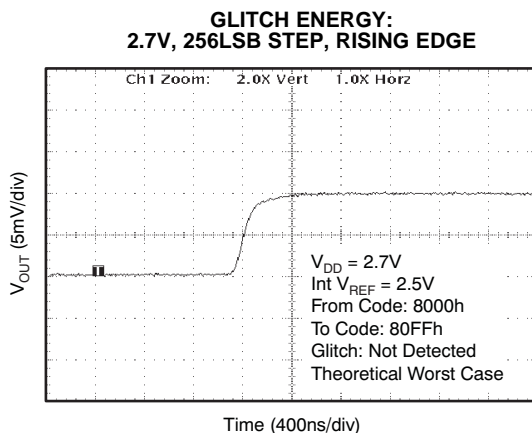

Figure 60.

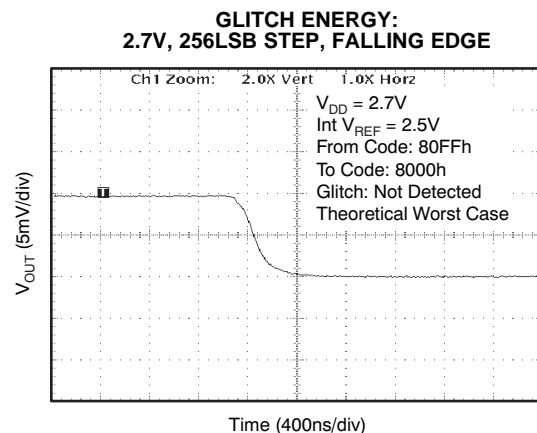

Figure 61.

## THEORY OF OPERATION

### DIGITAL-TO-ANALOG CONVERTER (DAC)

The DAC8560 architecture consists of a string DAC followed by an output buffer amplifier. Figure 62 shows a block diagram of the DAC architecture.

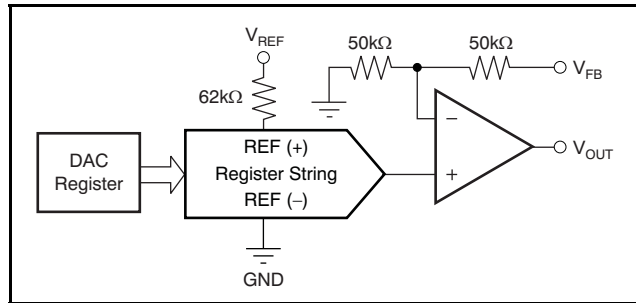

Figure 62. DAC8560 Architecture

The input coding to the DAC8560 is straight binary, so the ideal output voltage is given by:

$$V_{OUT} = \frac{D_{IN}}{65536} \times V_{REF}$$

where  $D_{IN}$  = decimal equivalent of the binary code that is loaded to the DAC register; it can range from 0 to 65535.

### RESISTOR STRING

The resistor string section is shown in Figure 63. It is simply a string of resistors, each of value R. The code loaded into the DAC register determines at which node on the string the voltage is tapped off by closing one of the switches connecting the string to the amplifier. It is monotonic because it is a string of resistors.

### OUTPUT AMPLIFIER

The output buffer amplifier is capable of generating rail-to-rail voltages on its output, giving an output range of 0V to  $V_{DD}$ . It is capable of driving a load of 2kΩ in parallel with 1000pF to GND. The source and sink capabilities of the output amplifier can be seen in the Typical Characteristics. The slew rate is 1.8V/μs with a full-scale settling time of 8μs with the output unloaded.

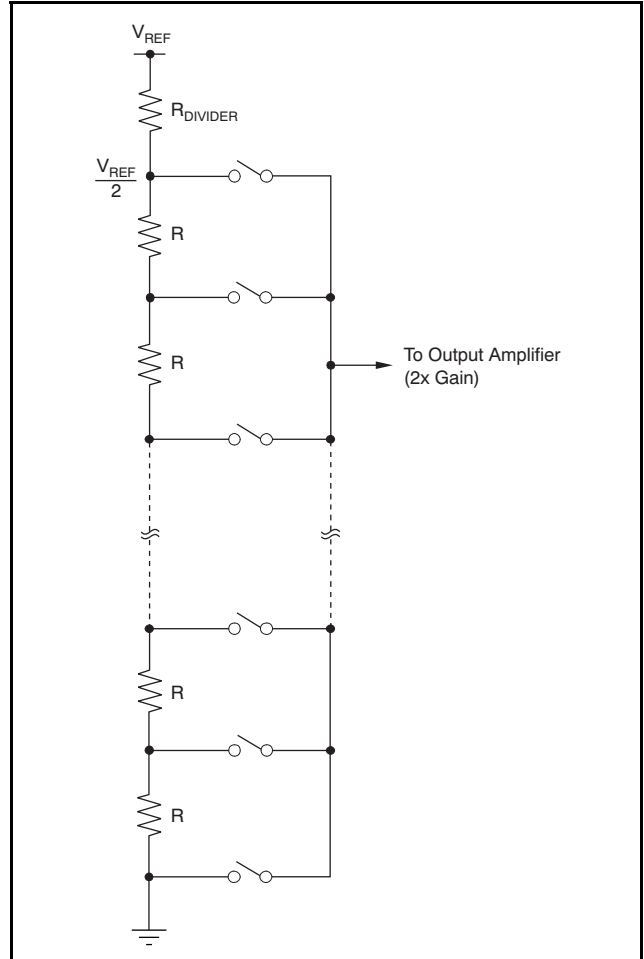

Figure 63. Resistor String

The inverting input of the output amplifier is available at the  $V_{FB}$  pin. This feature allows better accuracy in critical applications by tying the  $V_{FB}$  point and the amplifier output together directly at the load. Other signal conditioning circuitry may also be connected between these points for specific applications.

### INTERNAL REFERENCE

The DAC8560 includes a 2.5V internal reference that is enabled by default. The internal reference is externally available at the  $V_{REF}$  pin. A minimum 100nF capacitor is recommended between the reference output and GND for noise filtering.

The internal reference of the DAC8560 is a bipolar transistor-based, precision bandgap voltage reference. The basic bandgap topology is shown in Figure 64. Transistors  $Q_1$  and  $Q_2$  are biased such that the current density of  $Q_1$  is greater than that of  $Q_2$ . The difference of the two base-emitter voltages ( $V_{BE1} - V_{BE2}$ ) has a positive temperature coefficient and is forced across resistor  $R_1$ . This voltage is gained up and added to the base-emitter voltage of  $Q_2$ , which has a negative temperature coefficient. The resulting output voltage is virtually independent of temperature. The short-circuit current is limited by design to approximately 100mA.

#### Enable/Disable Internal Reference

The DAC8560 internal reference is enabled by default; however, the reference can be disabled for debugging or evaluation purposes. A serial command requiring at least two additional SCLK cycles at the end of the 24-bit write sequence (see [Serial Interface](#) section) must be used to disable the internal reference. For proper operation, a total of at least 26 SCLK cycles are required for each enable/disable internal reference update sequence, during which  $\overline{SYNC}$  must be held low. To disable the internal reference, execute the write sequence illustrated in Table 1 followed by at least two additional SCLK falling edges while  $\overline{SYNC}$  is low.

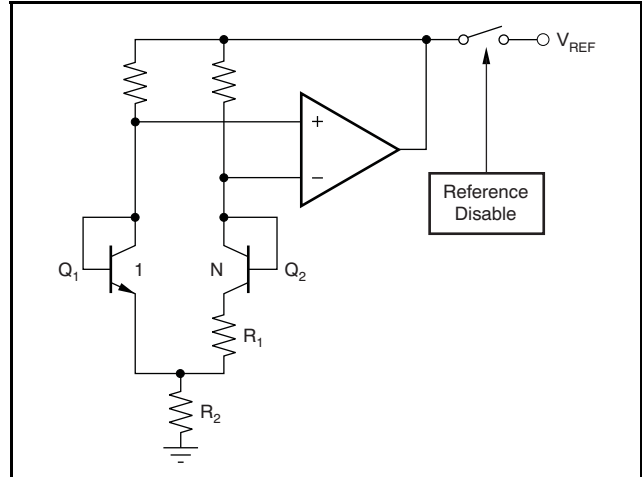

Figure 64. Simplified Schematic of the Bandgap Reference

To then enable the reference, either perform a power-cycle to reset the device, or sequentially execute the two write sequences in Table 2 and Table 3. Each of these write sequences must be followed by at least two additional SCLK falling edges while  $\overline{SYNC}$  remains low.

During the time that the internal reference is disabled, the DAC will function normally using an external reference. At this point, the internal reference is disconnected from the  $V_{REF}$  pin (tri-state). Do not attempt to drive the  $V_{REF}$  pin externally and internally at the same time indefinitely.

Table 1. Write Sequence for Disabling the DAC8560 Internal Reference

DB23																								DB0					
0	1	0	0	1	0	0	0	0	0	0	0	0	0	0	1	0	0	0	0	0	0	0	0	0	0	0	0	0	1

Table 2. Enabling the DAC8560 Internal Reference (Write Sequence 1 of 2)

DB23																								DB0					
0	1	0	0	1	1	0	0	0	0	0	0	0	0	1	0	0	0	0	0	0	0	0	0	0	0	0	0	0	0

Table 3. Enabling the DAC8560 Internal Reference (Write Sequence 2 of 2)

DB23																								DB0					
0	1	0	0	1	0	0	1	0	0	0	0	0	0	1	0	0	0	0	0	0	0	0	0	0	0	0	0	0	1

### SERIAL INTERFACE

The DAC8560 has a 3-wire serial interface ( $\overline{\text{SYNC}}$ , SCLK, and  $D_{\text{IN}}$ ) that is compatible with SPI, QSPI, and Microwire interface standards, as well as most DSPs. See the Serial Write Operation timing diagram for an example of a typical write sequence.

The write sequence begins by bringing the  $\overline{\text{SYNC}}$  line LOW. Data from the  $D_{\text{IN}}$  line is clocked into the 24-bit shift register on each falling edge of SCLK. The serial clock frequency can be as high as 30MHz, making the DAC8560 compatible with high-speed DSPs. On the 24th falling edge of the serial clock, the last data bit is clocked in and the programmed function is executed.

At this point, the  $\overline{\text{SYNC}}$  line may be kept LOW or brought HIGH. In either case, it must be brought HIGH for a minimum of 33ns before the next write sequence so that a falling edge of  $\overline{\text{SYNC}}$  can initiate the next write sequence. As previously mentioned, it must be brought HIGH again before the next write sequence.

### INPUT SHIFT REGISTER

The input shift register is 24 bits wide, as shown in Table 4. The first six bits must be '000000'. The next two bits (PD1 and PD0) are control bits that set the desired mode of operation (normal mode or any one of three power-down modes) as indicated in Table 5.

A more complete description of the various modes is located in the [Power-Down Modes](#) section. The next 16 bits are the data bits, which are transferred to the DAC register on the 24th falling edge of SCLK under normal operation (see Table 5).

### $\overline{\text{SYNC}}$ INTERRUPT

In a normal write sequence, the  $\overline{\text{SYNC}}$  line is kept LOW for at least 24 falling edges of SCLK and the DAC is updated on the 24th falling edge. However, if  $\overline{\text{SYNC}}$  is brought HIGH before the 24th falling edge, it acts as an interrupt to the write sequence. The shift register is reset, and the write sequence is seen as invalid. Neither an update of the DAC register contents, nor a change in the operating mode occurs, as shown in Figure 65.

### POWER-ON RESET

The DAC8560 contains a power-on-reset circuit that controls the output voltage during power up. On power up, all registers are filled with zeros and the output voltage is zero-scale; it remains there until a valid write sequence is made to the DAC. This feature is useful in applications where it is important to know the state of the output of the DAC while it is in the process of powering up.

Table 4. DAC8560 Data Input Register Format

DB23																								DB0					
0	0	0	0	0	0	PD1	PD0	D15	D14	D13	D12	D11	D10	D9	D8	D7	D6	D5	D4	D3	D2	D1	D0						

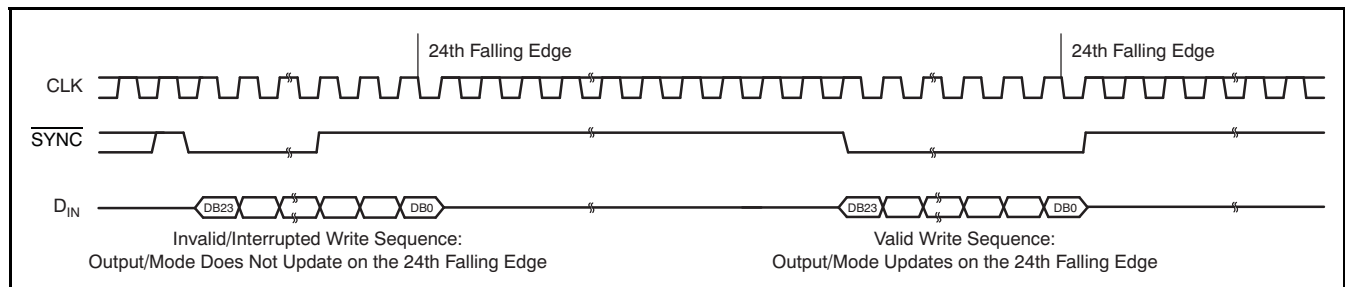

Figure 65.  $\overline{\text{SYNC}}$  Interrupt Facility

## POWER-DOWN MODES

The DAC8560 supports four separate modes of operation. These modes are programmable by setting two bits (PD1 and PD0) in the control register. Table 5 shows how to control the operating mode with data bits PD1 (DB17) and PD0 (DB16).

**Table 5. Operating Modes**

PD1 (DB17)	PD0 (DB16)	OPERATING MODE
0	0	Normal operation
0	1	Power-down 1 kΩ to GND
1	0	Power-down 100 kΩ to GND
1	1	Power-down High-Z

When both bits are set to '0', the device works normally with its typical current consumption of 530μA at 5.5V. However, for the three power-down modes, the supply current falls to 1.2μA at 5.5V (0.7μA at 3.6V). Not only does the supply current fall, but the output stage is also internally switched from the output of the amplifier to a resistor network of known values.

The advantage of this switching is that the output impedance of the device is known while it is in power-down mode. As shown in Table 5, there are three different power-down options.  $V_{OUT}$  can be connected internally to GND through a 1kΩ resistor, a 100kΩ resistor, or open circuited (High-Z). The output stage is illustrated in Figure 66.

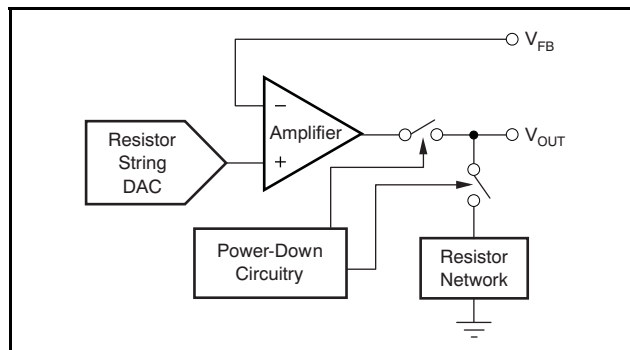

**Figure 66. Output Stage During Power Down**

All analog circuitry is shut down when the power-down mode is activated. However, the contents of the DAC register are unaffected when in power down. The time to exit power-down is typically 2.5μs for  $V_{DD} = 5V$ , and 5μs for  $V_{DD} = 3V$ . See the Typical Characteristics for more information.

## APPLICATION INFORMATION

### INTERNAL REFERENCE

The DAC8560 internal reference does not require an external load capacitor for stability because it is stable with any capacitive load. However, for improved noise performance, an external load capacitor of 150nF or larger connected to the  $V_{REF}$  output is recommended. Figure 67 shows the typical connections required for operation of the DAC8560 internal reference. A supply bypass capacitor at the  $V_{DD}$  input is also recommended.

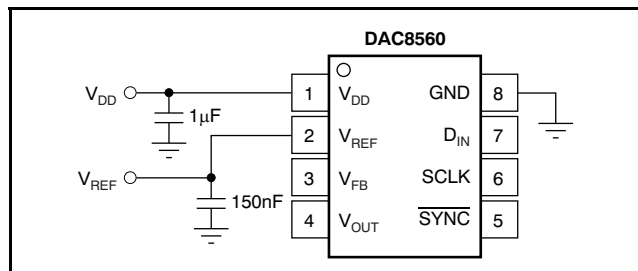

Figure 67. Typical Connections for Operating the DAC8560 Internal Reference

### Supply Voltage

The DAC8560 internal reference features an extremely low dropout voltage. It can be operated with a supply of only 5mV above the reference output voltage in an unloaded condition. For loaded conditions, refer to the Load Regulation section. The stability of the DAC8560 internal reference with variations in supply voltage (line regulation, DC PSRR) is also exceptional. Within the specified supply voltage range of 2.7V to 5.5V, the variation at  $V_{REF}$  is smaller than 10µV/V; see the Typical Characteristics.

### Temperature Drift

The DAC8560 internal reference is designed to exhibit minimal drift error, defined as the change in reference output voltage over varying temperature. The drift is calculated using the box method, which is described by Equation 2:

$$\text{Drift Error} = \left( \frac{V_{REF\_MAX} - V_{REF\_MIN}}{V_{REF} \times T_{RANGE}} \right) \times 10^6 \text{ (ppm/}^\circ\text{C)}$$

Where:

$V_{REF\_MAX}$  = maximum reference voltage observed within temperature range  $T_{RANGE}$ .

$V_{REF\_MIN}$  = minimum reference voltage observed within temperature range  $T_{RANGE}$ .

$V_{REF} = 2.5V$ , target value for reference output voltage.

The DAC8560 internal reference (grades C and D) features an exceptional typical drift coefficient of 2ppm/°C from -40°C to +120°C. Characterizing a large number of units, a maximum drift coefficient of 5ppm/°C (grades C and D) is observed. Temperature drift results are summarized in the Typical Characteristics.

### Noise Performance

Typical 0.1Hz to 10Hz voltage noise can be seen in Figure 8, Internal Reference Noise. Additional filtering can be used to improve output noise levels, although care should be taken to ensure the output impedance does not degrade the AC performance. The output noise spectrum at  $V_{REF}$  without any external components is depicted in Figure 7, Internal Reference Noise Density vs Frequency. Another noise density spectrum is also shown in Figure 7, which was obtained using a 4µF load capacitor at  $V_{REF}$  for noise filtering. Internal reference noise impacts the DAC output noise; see the DAC Noise Performance section for more details.

### Load Regulation

Load regulation is defined as the change in reference output voltage as a result of changes in load current. The load regulation of the DAC8560 internal reference is measured using force and sense contacts as pictured in Figure 68. The force and sense lines reduce the impact of contact and trace resistance, resulting in accurate measurement of the load regulation contributed solely by the DAC8560 internal reference. Measurement results are summarized in the Typical Characteristics. Force and sense lines should be used for applications requiring improved load regulation.

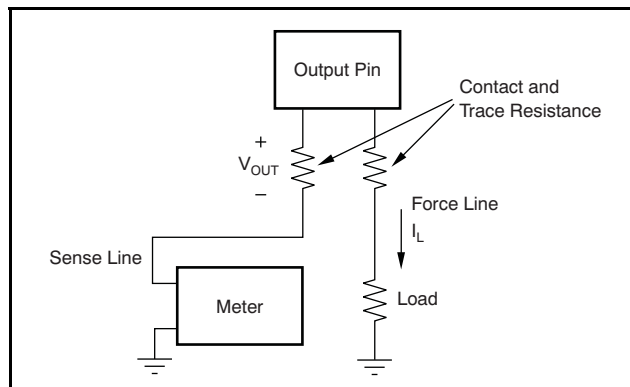

Figure 68. Accurate Load Regulation of the DAC8560 Internal Reference

## Long-Term Stability

Long-term stability/aging refers to the change of the output voltage of a reference over a period of months or years. This effect lessens as time progresses, as shown in [Figure 6](#), the typical long-term stability curve. The typical drift value for the DAC8560 internal reference is 50ppm from 0 hours to 1900 hours. This parameter is characterized by powering-up and measuring 20 units at regular intervals for a period of 1900 hours.

## Thermal Hysteresis

Thermal hysteresis for a reference is defined as the change in output voltage after operating the device at +25°C, cycling the device through the specified temperature range, and returning to +25°C. It is expressed in [Equation 3](#):

$$V_{\text{HYST}} = \left( \frac{|V_{\text{REF\_PRE}} - V_{\text{REF\_POST}}|}{V_{\text{REF\_NOM}}} \right) \times 10^6 \text{ (ppm)}$$

Where:

$V_{\text{HYST}}$  = thermal hysteresis.

$V_{\text{REF\_PRE}}$  = output voltage measured at +25°C pre-temperature cycling.

$V_{\text{REF\_POST}}$  = output voltage measured after the device has been cycled through the temperature range of –40°C to +120°C, and returned to +25°C.

## DAC NOISE PERFORMANCE

Typical noise performance for the DAC8560 with the internal reference enabled is shown in [Figure 39](#) to [Figure 41](#). Output noise spectral density at pin  $V_{\text{OUT}}$  versus frequency is depicted in [Figure 39](#) for full-scale, midscale, and zero scale input codes. The typical noise density for midscale code is 170nV/ $\sqrt{\text{Hz}}$  at 1kHz and 100nV/ $\sqrt{\text{Hz}}$  at 1MHz. High-frequency noise can be improved by filtering the reference noise as shown in [Figure 40](#), where a 4 $\mu\text{F}$  load capacitor is connected to the  $V_{\text{REF}}$  pin and compared to the no-load condition. Integrated output noise between 0.1Hz and 10Hz is close to 50 $\mu\text{V}_{\text{PP}}$  (midscale), as shown in [Figure 41](#).

## BIPOLAR OPERATION USING THE DAC8560

The DAC8560 has been designed for single-supply operation, but a bipolar output range is also possible using the circuit in either [Figure 69](#) or [Figure 70](#). The circuit shown gives an output voltage range of  $\pm V_{\text{REF}}$ . Rail-to-rail operation at the amplifier output is achievable using an [OPA703](#) as the output amplifier.

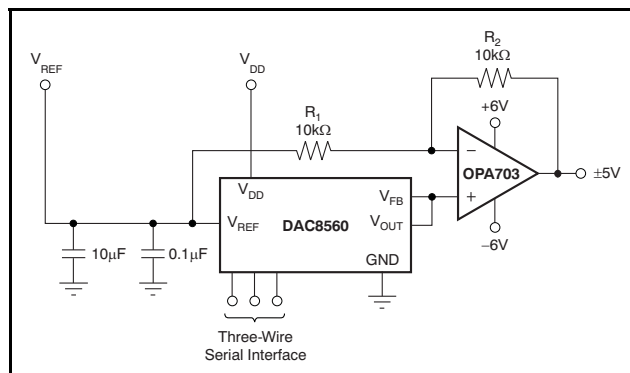

**Figure 69. Bipolar Output Range Using External Reference at 5V**

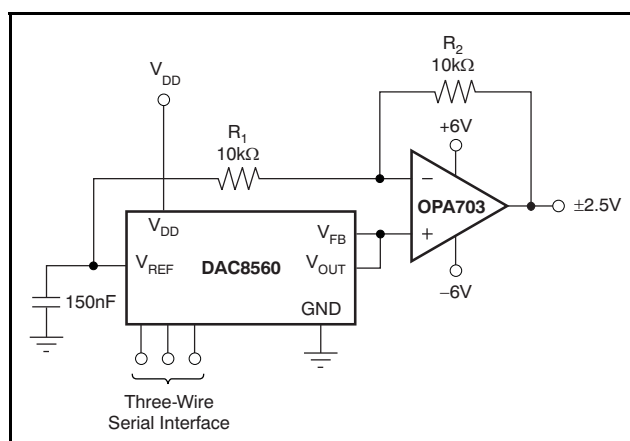

**Figure 70. Bipolar Output Range Using Internal Reference**

The output voltage for any input code can be calculated as using [Equation 4](#):

$$V_o = \left[ V_{\text{REF}} \times \left( \frac{D}{65536} \right) \times \left( \frac{R_1 + R_2}{R_1} \right) - V_{\text{REF}} \times \left( \frac{R_2}{R_1} \right) \right]$$

where  $D$  represents the input code in decimal (0–65535).

With  $V_{\text{REF}} = 5\text{V}$ ,  $R_1 = R_2 = 10\text{k}\Omega$ .

$$V_o = \left( \frac{10 \times D}{65536} \right) - 5\text{V}$$

This result has an output voltage range of  $\pm 5\text{V}$  with 0000h corresponding to a –5V output and FFFFh corresponding to a 5V output, as shown in [Figure 69](#). Similarly, using the internal reference, a  $\pm 2.5\text{V}$  output voltage range can be achieved, as shown in [Figure 70](#).



## MICROPROCESSOR INTERFACING

### DAC8560 TO 8051 Interface

See [Figure 71](#) for a serial interface between the DAC8560 and a typical 8051-type microcontroller. The setup for the interface is as follows: TXD of the 8051 drives SCLK of the DAC8560, while RXD drives the serial data line of the device. The  $\overline{\text{SYNC}}$  signal is derived from a bit-programmable pin on the port of the 8051. In this case, port line P3.3 is used. When data is to be transmitted to the DAC8560, P3.3 is taken LOW. The 8051 transmits data in 8-bit bytes; thus, only eight falling clock edges occur in the transmit cycle. To load data to the DAC, P3.3 is left LOW after the first eight bits are transmitted, then a second write cycle is initiated to transmit the second byte of data. P3.3 is taken HIGH following the completion of the third write cycle. The 8051 outputs the serial data in a format which has the LSB first. The DAC8560 requires its data with the MSB as the first bit received. The 8051 transmit routine must therefore take this into account, and *mirror* the data as needed.

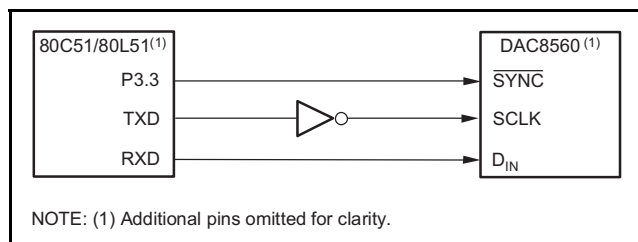

**Figure 71. DAC8560 to 80C51/80L51 Interface**

### DAC8560 to Microwire Interface

[Figure 72](#) shows an interface between the DAC8560 and any Microwire compatible device. Serial data is shifted out on the falling edge of the serial clock and is clocked into the DAC8560 on the rising edge of the SK signal.

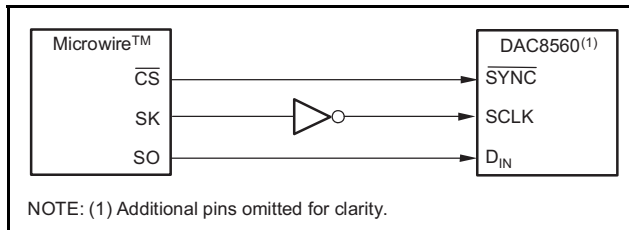

**Figure 72. DAC8560 to Microwire Interface**

### DAC8560 to 68HC11 Interface

[Figure 73](#) shows a serial interface between the DAC8560 and the 68HC11 microcontroller. SCK of the 68HC11 drives the SCLK of the DAC8560, while the MOSI output drives the serial data line of the DAC. The  $\overline{\text{SYNC}}$  signal is derived from a port line (PC7), similar to the 8051 diagram.

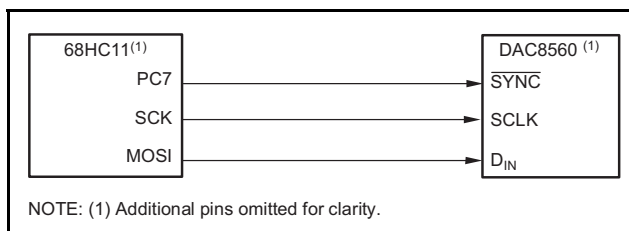

**Figure 73. DAC8560 to 68HC11 Interface**

The 68HC11 should be configured so that its CPOL bit is '0' and its CPHA bit is '1'. This configuration causes data appearing on the MOSI output to be valid on the falling edge of SCK. When data is being transmitted to the DAC, the  $\overline{\text{SYNC}}$  line is held LOW (PC7). Serial data from the 68HC11 is transmitted in 8-bit bytes with only eight falling clock edges occurring in the transmit cycle. (Data is transmitted MSB first.) In order to load data to the DAC8560, PC7 is left LOW after the first eight bits are transferred, then a second and third serial write operation is performed to the DAC. PC7 is taken HIGH at the end of this procedure.



## LAYOUT

A precision analog component requires careful layout, adequate bypassing, and clean, well-regulated power supplies.

The DAC8560 offers single-supply operation, and it often is used in close proximity with digital logic, microcontrollers, microprocessors, and digital signal processors. The more digital logic present in the design and the higher the switching speed, the more difficult it is to keep digital noise from appearing at the output.

As a result of the single ground pin of the DAC8560, all return currents, including digital and analog return currents for the DAC, must flow through a single point. Ideally, GND would be connected directly to an analog ground plane. This plane would be separate from the ground connection for the digital components until they were connected at the power-entry point of the system.

The power applied to  $V_{DD}$  should be well regulated and low noise. Switching power supplies and DC/DC converters often have high-frequency glitches or spikes riding on the output voltage. In addition, digital components can create similar high-frequency spikes as their internal logic switches states. This noise can easily couple into the DAC output voltage through various paths between the power connections and analog output.

As with the GND connection,  $V_{DD}$  should be connected to a power-supply plane or trace that is separate from the connection for digital logic until they are connected at the power-entry point. In addition, a  $1\mu\text{F}$  to  $10\mu\text{F}$  capacitor and  $0.1\mu\text{F}$  bypass capacitor are strongly recommended. In some situations, additional bypassing may be required, such as a  $100\mu\text{F}$  electrolytic capacitor or even a *Pi* filter made up of inductors and capacitors – all designed to essentially low-pass filter the supply, removing the high-frequency noise.

**PACKAGING INFORMATION**

Orderable Device	Status <sup>(1)</sup>	Package Type	Package Drawing	Pins	Package Qty	Eco Plan <sup>(2)</sup>	Lead/Ball Finish	MSL Peak Temp <sup>(3)</sup>
DAC8560IADGKR	ACTIVE	MSOP	DGK	8	2500	Green (RoHS & no Sb/Br)	CU NIPDAU	Level-2-260C-1 YEAR
DAC8560IADGKRG4	ACTIVE	MSOP	DGK	8	2500	Green (RoHS & no Sb/Br)	CU NIPDAU	Level-2-260C-1 YEAR
DAC8560IADGKT	ACTIVE	MSOP	DGK	8	250	Green (RoHS & no Sb/Br)	CU NIPDAU	Level-2-260C-1 YEAR
DAC8560IADGKTG4	ACTIVE	MSOP	DGK	8	250	Green (RoHS & no Sb/Br)	CU NIPDAU	Level-2-260C-1 YEAR
DAC8560IBDGKR	ACTIVE	MSOP	DGK	8	2500	Green (RoHS & no Sb/Br)	CU NIPDAU	Level-2-260C-1 YEAR
DAC8560IBDGKRG4	ACTIVE	MSOP	DGK	8	2500	Green (RoHS & no Sb/Br)	CU NIPDAU	Level-2-260C-1 YEAR
DAC8560IBDGKT	ACTIVE	MSOP	DGK	8	250	Green (RoHS & no Sb/Br)	CU NIPDAU	Level-2-260C-1 YEAR
DAC8560IBDGKTG4	ACTIVE	MSOP	DGK	8	250	Green (RoHS & no Sb/Br)	CU NIPDAU	Level-2-260C-1 YEAR
DAC8560ICDGKR	ACTIVE	MSOP	DGK	8	2500	Green (RoHS & no Sb/Br)	CU NIPDAU	Level-2-260C-1 YEAR
DAC8560ICDGKRG4	ACTIVE	MSOP	DGK	8	2500	Green (RoHS & no Sb/Br)	CU NIPDAU	Level-2-260C-1 YEAR
DAC8560ICDGKT	ACTIVE	MSOP	DGK	8	250	Green (RoHS & no Sb/Br)	CU NIPDAU	Level-2-260C-1 YEAR
DAC8560ICDGKTG4	ACTIVE	MSOP	DGK	8	250	Green (RoHS & no Sb/Br)	CU NIPDAU	Level-2-260C-1 YEAR
DAC8560IDDGKR	ACTIVE	MSOP	DGK	8	2500	Green (RoHS & no Sb/Br)	CU NIPDAU	Level-2-260C-1 YEAR
DAC8560IDDGKRG4	ACTIVE	MSOP	DGK	8	2500	Green (RoHS & no Sb/Br)	CU NIPDAU	Level-2-260C-1 YEAR
DAC8560IDDGKT	ACTIVE	MSOP	DGK	8	250	Green (RoHS & no Sb/Br)	CU NIPDAU	Level-2-260C-1 YEAR
DAC8560IDDGKTG4	ACTIVE	MSOP	DGK	8	250	Green (RoHS & no Sb/Br)	CU NIPDAU	Level-2-260C-1 YEAR

<sup>(1)</sup> The marketing status values are defined as follows:

**ACTIVE:** Product device recommended for new designs.

**LIFEBUY:** TI has announced that the device will be discontinued, and a lifetime-buy period is in effect.

**NRND:** Not recommended for new designs. Device is in production to support existing customers, but TI does not recommend using this part in a new design.

**PREVIEW:** Device has been announced but is not in production. Samples may or may not be available.

**OBSOLETE:** TI has discontinued the production of the device.

<sup>(2)</sup> Eco Plan - The planned eco-friendly classification: Pb-Free (RoHS), Pb-Free (RoHS Exempt), or Green (RoHS & no Sb/Br) - please check <http://www.ti.com/productcontent> for the latest availability information and additional product content details.

**TBD:** The Pb-Free/Green conversion plan has not been defined.

**Pb-Free (RoHS):** TI's terms "Lead-Free" or "Pb-Free" mean semiconductor products that are compatible with the current RoHS requirements for all 6 substances, including the requirement that lead not exceed 0.1% by weight in homogeneous materials. Where designed to be soldered at high temperatures, TI Pb-Free products are suitable for use in specified lead-free processes.

**Pb-Free (RoHS Exempt):** This component has a RoHS exemption for either 1) lead-based flip-chip solder bumps used between the die and package, or 2) lead-based die adhesive used between the die and leadframe. The component is otherwise considered Pb-Free (RoHS compatible) as defined above.

**Green (RoHS & no Sb/Br):** TI defines "Green" to mean Pb-Free (RoHS compatible), and free of Bromine (Br) and Antimony (Sb) based flame retardants (Br or Sb do not exceed 0.1% by weight in homogeneous material)

<sup>(3)</sup> MSL, Peak Temp. -- The Moisture Sensitivity Level rating according to the JEDEC industry standard classifications, and peak solder temperature.

**Important Information and Disclaimer:**The information provided on this page represents TI's knowledge and belief as of the date that it is provided. TI bases its knowledge and belief on information provided by third parties, and makes no representation or warranty as to the accuracy of such information. Efforts are underway to better integrate information from third parties. TI has taken and continues to take reasonable steps to provide representative and accurate information but may not have conducted destructive testing or chemical analysis on incoming materials and chemicals. TI and TI suppliers consider certain information to be proprietary, and thus CAS numbers and other limited information may not be available for release.

In no event shall TI's liability arising out of such information exceed the total purchase price of the TI part(s) at issue in this document sold by TI to Customer on an annual basis.

DGK (S-PDSO-G8)

PLASTIC SMALL-OUTLINE PACKAGE

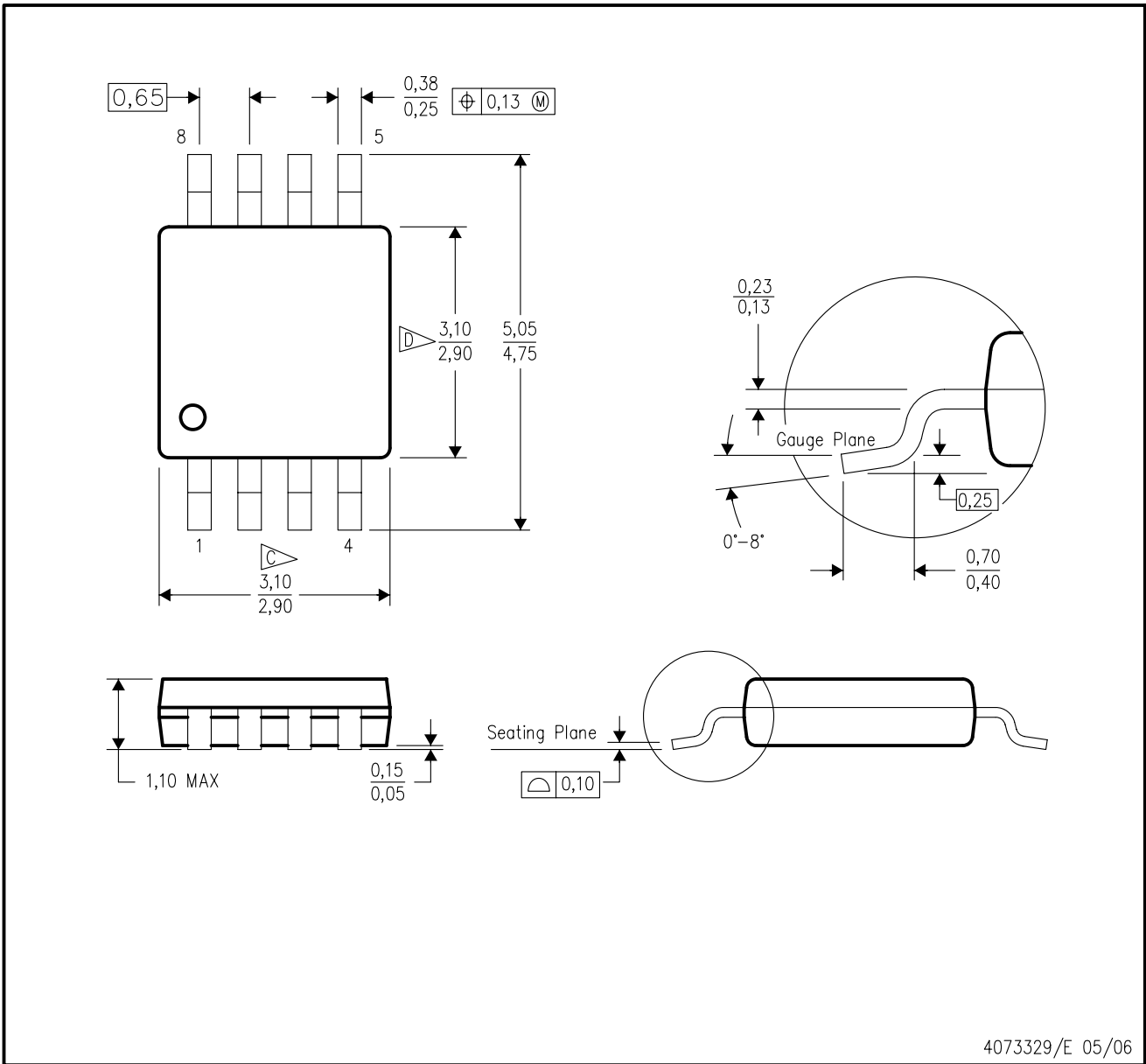

- NOTES:
- A. All linear dimensions are in millimeters.
  - B. This drawing is subject to change without notice.
  - C. Body length does not include mold flash, protrusions, or gate burrs. Mold flash, protrusions, or gate burrs shall not exceed 0.15 per end.
  - D. Body width does not include interlead flash. Interlead flash shall not exceed 0.50 per side.
  - E. Falls within JEDEC MO-187 variation AA, except interlead flash.

## IMPORTANT NOTICE

Texas Instruments Incorporated and its subsidiaries (TI) reserve the right to make corrections, modifications, enhancements, improvements, and other changes to its products and services at any time and to discontinue any product or service without notice. Customers should obtain the latest relevant information before placing orders and should verify that such information is current and complete. All products are sold subject to TI's terms and conditions of sale supplied at the time of order acknowledgment.

TI warrants performance of its hardware products to the specifications applicable at the time of sale in accordance with TI's standard warranty. Testing and other quality control techniques are used to the extent TI deems necessary to support this warranty. Except where mandated by government requirements, testing of all parameters of each product is not necessarily performed.

TI assumes no liability for applications assistance or customer product design. Customers are responsible for their products and applications using TI components. To minimize the risks associated with customer products and applications, customers should provide adequate design and operating safeguards.

TI does not warrant or represent that any license, either express or implied, is granted under any TI patent right, copyright, mask work right, or other TI intellectual property right relating to any combination, machine, or process in which TI products or services are used. Information published by TI regarding third-party products or services does not constitute a license from TI to use such products or services or a warranty or endorsement thereof. Use of such information may require a license from a third party under the patents or other intellectual property of the third party, or a license from TI under the patents or other intellectual property of TI.

Reproduction of information in TI data books or data sheets is permissible only if reproduction is without alteration and is accompanied by all associated warranties, conditions, limitations, and notices. Reproduction of this information with alteration is an unfair and deceptive business practice. TI is not responsible or liable for such altered documentation.

Resale of TI products or services with statements different from or beyond the parameters stated by TI for that product or service voids all express and any implied warranties for the associated TI product or service and is an unfair and deceptive business practice. TI is not responsible or liable for any such statements.

Following are URLs where you can obtain information on other Texas Instruments products and application solutions:

<b>Products</b>		<b>Applications</b>	
Amplifiers	<a href="http://amplifier.ti.com">amplifier.ti.com</a>	Audio	<a href="http://www.ti.com/audio">www.ti.com/audio</a>
Data Converters	<a href="http://dataconverter.ti.com">dataconverter.ti.com</a>	Automotive	<a href="http://www.ti.com/automotive">www.ti.com/automotive</a>
DSP	<a href="http://dsp.ti.com">dsp.ti.com</a>	Broadband	<a href="http://www.ti.com/broadband">www.ti.com/broadband</a>
Interface	<a href="http://interface.ti.com">interface.ti.com</a>	Digital Control	<a href="http://www.ti.com/digitalcontrol">www.ti.com/digitalcontrol</a>
Logic	<a href="http://logic.ti.com">logic.ti.com</a>	Military	<a href="http://www.ti.com/military">www.ti.com/military</a>
Power Mgmt	<a href="http://power.ti.com">power.ti.com</a>	Optical Networking	<a href="http://www.ti.com/opticalnetwork">www.ti.com/opticalnetwork</a>
Microcontrollers	<a href="http://microcontroller.ti.com">microcontroller.ti.com</a>	Security	<a href="http://www.ti.com/security">www.ti.com/security</a>
Low Power Wireless	<a href="http://www.ti.com/lpw">www.ti.com/lpw</a>	Telephony	<a href="http://www.ti.com/telephony">www.ti.com/telephony</a>
		Video & Imaging	<a href="http://www.ti.com/video">www.ti.com/video</a>
		Wireless	<a href="http://www.ti.com/wireless">www.ti.com/wireless</a>

Mailing Address: Texas Instruments  
Post Office Box 655303 Dallas, Texas 75265