

### FEATURES

- Double Side Cooling
- High Surge Capability

### APPLICATIONS

- High Power Drives
- High Voltage Power Supplies
- DC Motor Control
- Welding
- Battery Chargers

### VOLTAGE RATINGS

Type Number	Repetitive Peak Voltages $V_{DRM}$ $V_{RRM}$ V	Conditions
DCR1020SF65	6500	$T_{vj} = 0^\circ \text{ to } 125^\circ \text{C}$ , $I_{DRM} = I_{RRM} = 150\text{mA}$ , $V_{DRM}, V_{RRM} t_p = 10\text{ms}$ , $V_{DSM} \text{ \& } V_{RSM} =$ $V_{DRM} \text{ \& } V_{RRM} + 100\text{V}$ respectively
DCR1020SF64	6400	
DCR1020SF63	6300	
DCR1020SF62	6200	
DCR1020SF61	6100	
DCR1020SF60	6000	

Lower voltage grades available.

### ORDERING INFORMATION

When ordering, select the required part number shown in the Voltage Ratings selection table.

For example:

**DCR1020SF63**

Note: Please use the complete part number when ordering and quote this number in any future correspondence relating to your order.

### KEY PARAMETERS

$V_{DRM}$  **6500V**

$I_{T(AV)}$  **640A**

$I_{TSM}$  **10700A**

$dV/dt$  **1000V/ $\mu\text{s}$**

$dI/dt$  **100A/ $\mu\text{s}$**

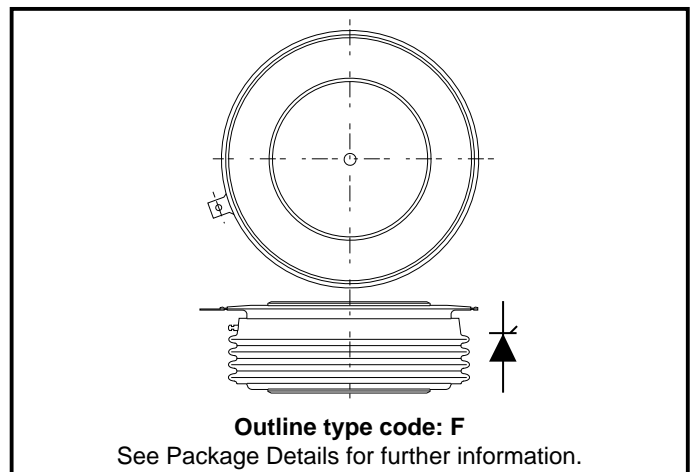

Fig. 1 Package outline

**CURRENT RATINGS**

$T_{case} = 60^{\circ}\text{C}$  unless stated otherwise.

Symbol	Parameter	Conditions	Max.	Units
<b>Double Side Cooled</b>				
$I_{T(AV)}$	Mean on-state current	Half wave resistive load	640	A
$I_{T(RMS)}$	RMS value	-	1005	A
$I_T$	Continuous (direct) on-state current	-	967	A
<b>Single Side Cooled (Anode side)</b>				
$I_{T(AV)}$	Mean on-state current	Half wave resistive load	473	A
$I_{T(RMS)}$	RMS value	-	742	A
$I_T$	Continuous (direct) on-state current	-	682	A

**CURRENT RATINGS**

$T_{case} = 80^{\circ}\text{C}$  unless stated otherwise.

Symbol	Parameter	Conditions	Max.	Units
<b>Double Side Cooled</b>				
$I_{T(AV)}$	Mean on-state current	Half wave resistive load	515	A
$I_{T(RMS)}$	RMS value	-	809	A
$I_T$	Continuous (direct) on-state current	-	765	A
<b>Single Side Cooled (Anode side)</b>				
$I_{T(AV)}$	Mean on-state current	Half wave resistive load	377	A
$I_{T(RMS)}$	RMS value	-	592	A
$I_T$	Continuous (direct) on-state current	-	530	A

**SURGE RATINGS**

Symbol	Parameter	Conditions	Max.	Units
$I_{TSM}$	Surge (non-repetitive) on-state current	10ms half sine; $T_{case} = 125^{\circ}C$	8.5	kA
$I^2t$	$I^2t$ for fusing	$V_R = 50\% V_{RRM}$ - 1/4 sine	$0.36 \times 10^6$	A <sup>2</sup> s
$I_{TSM}$	Surge (non-repetitive) on-state current	10ms half sine; $T_{case} = 125^{\circ}C$	10.7	kA
$I^2t$	$I^2t$ for fusing	$V_R = 0$	$0.562 \times 10^6$	A <sup>2</sup> s

**THERMAL AND MECHANICAL DATA**

Symbol	Parameter	Conditions	Min.	Max.	Units	
$R_{th(j-c)}$	Thermal resistance - junction to case	Double side cooled	dc	-	0.022	$^{\circ}C/W$
		Single side cooled	Anode dc	-	0.038	$^{\circ}C/W$
			Cathode dc	-	0.052	$^{\circ}C/W$
$R_{th(c-h)}$	Thermal resistance - case to heatsink	Clamping force 19.5kN with mounting compound	Double side	-	0.004	$^{\circ}C/W$
			Single side	-	0.008	$^{\circ}C/W$
$T_{vj}$	Virtual junction temperature	On-state (conducting)		-	135	$^{\circ}C$
		Reverse (blocking)		-	125	$^{\circ}C$
$T_{stg}$	Storage temperature range			-55	125	$^{\circ}C$
-	Clamping force			18.0	22.0	kN

## DYNAMIC CHARACTERISTICS

Symbol	Parameter	Conditions	Typ.	Max.	Units	
$V_{TM}$	Maximum on-state voltage	At 1800A peak, $T_{case} = 25^{\circ}C$	-	3.6	V	
$I_{RRM}/I_{DRM}$	Peak reverse and off-state current	At $V_{RRM}/V_{DRM}$ , $T_{case} = 125^{\circ}C$	-	150	mA	
$dV/dt$	Maximum linear rate of rise of off-state voltage	To 67% $V_{DRM}$ , $T_j = 125^{\circ}C$ .	-	1000	V/ $\mu s$	
$di/dt$	Rate of rise of on-state current	From 67% $V_{DRM}$ to 1000A Gate source 30V, 15 $\Omega$ $t_r \leq 0.5\mu s$ , $T_j = 125^{\circ}C$ .	Repetitive 50Hz	-	30	A/ $\mu s$
			Non-repetitive	-	100	A/ $\mu s$
$V_{T(TO)}$	Threshold voltage	At $T_{vj} = 125^{\circ}C$	-	1.2	V	
$r_T$	On-state slope resistance	At $T_{vj} = 125^{\circ}C$	-	1.92	m $\Omega$	
$t_{gd}$	Delay time	$V_D = 67\% V_{DRM}$ , Gate source 30V, 15 $\Omega$ Rise time 0.5 $\mu s$ , $T_j = 25^{\circ}C$	0.5	1.5	$\mu s$	
$t_q$	Turn-off time	$I_T = 1000A$ , $t_p = 1ms$ , $T_j = 125^{\circ}C$ , $V_{RM} = 100V$ , $dI_{RR}/dt = 10A/\mu s$ , $V_{DR} = 67\% V_{DRM}$ , $dV_{DR}/dt = 25V/\mu s$	600	-	$\mu s$	
$I_L$	Latching current	$T_j = 25^{\circ}C$ , $V_D = 10V$	-	600	mA	
$I_H$	Holding current	$T_j = 25^{\circ}C$	-	200	mA	

## GATE TRIGGER CHARACTERISTICS AND RATINGS

Symbol	Parameter	Conditions	Typ.	Max.	Units
$V_{GT}$	Gate trigger voltage	$V_{DRM} = 5V$ , $T_{case} = 25^{\circ}C$	-	3.0	V
$I_{GT}$	Gate trigger current	$V_{DRM} = 5V$ , $T_{case} = 25^{\circ}C$	-	300	mA
$V_{GD}$	Gate non-trigger voltage	At $V_{DRM}$ , $T_{case} = 125^{\circ}C$	-	0.25	V
$V_{FGM}$	Peak forward gate voltage	Anode positive with respect to cathode	-	30	V
$V_{FGN}$	Peak forward gate voltage	Anode negative with respect to cathode	-	0.25	V
$V_{RGM}$	Peak reverse gate voltage		-	5	V
$I_{FGM}$	Peak forward gate current	Anode positive with respect to cathode	-	10	A
$P_{G(M)}$	Peak gate power	See Gate Characteristics curve/table	-	150	W
$P_{G(AV)}$	Mean gate power		-	5	W

**CURVES**

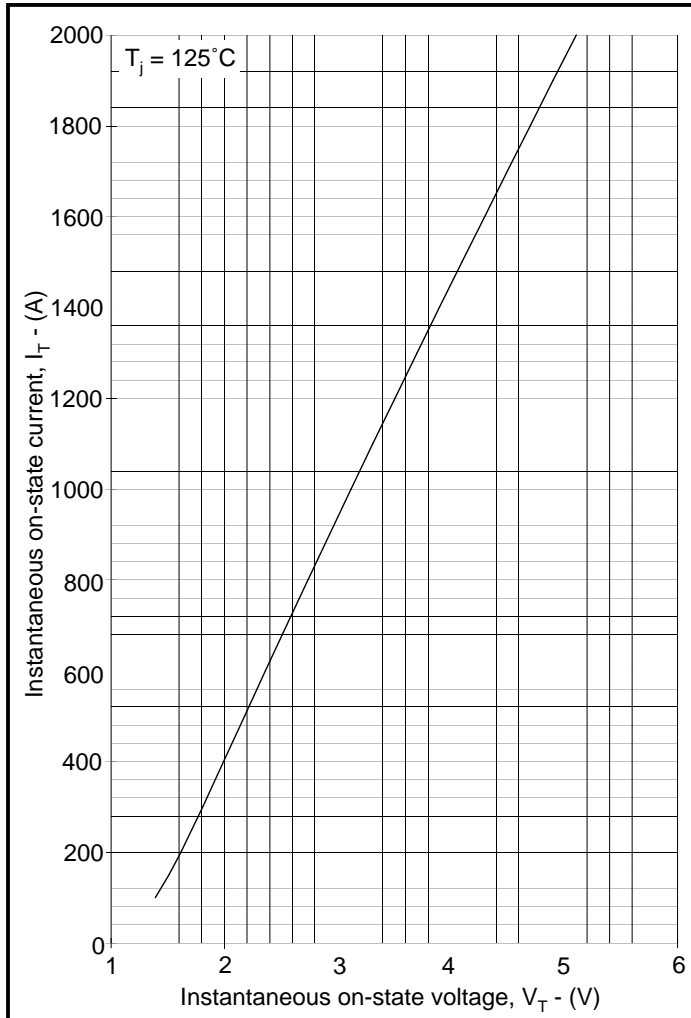

**Fig.2 Maximum (limit) on-state characteristics**

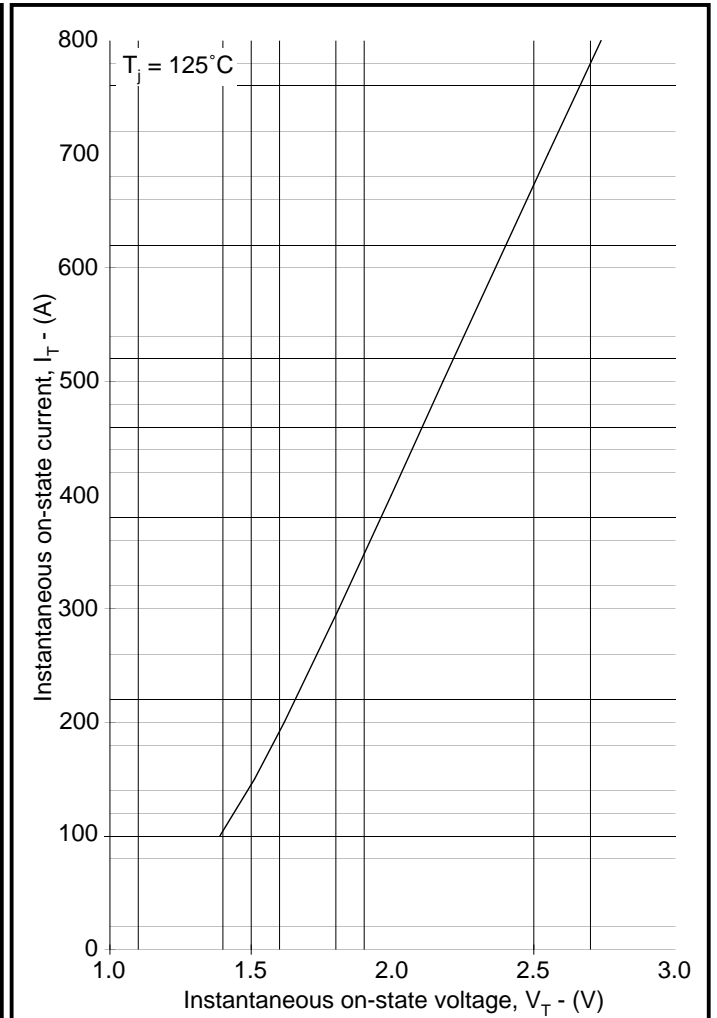

**Fig.3 Maximum (limit) on-state characteristics**

$V_{TM}$  Equation:-

$$V_{TM} = A + B \ln(I_T) + C \cdot I_T + D \cdot \sqrt{I_T}$$

Where

A = 0.25863

B = 0.322589

C = 0.002564

D = -0.061059

these values are valid for  $T_j = 125^\circ\text{C}$  for  $I_T$  100A to 2000A

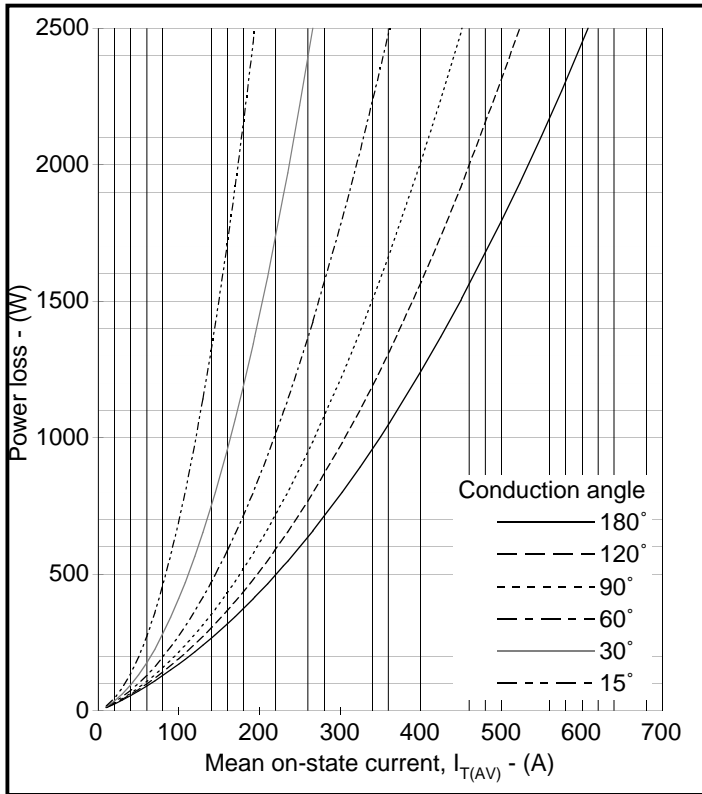

Fig.4 Sine wave power dissipation curves

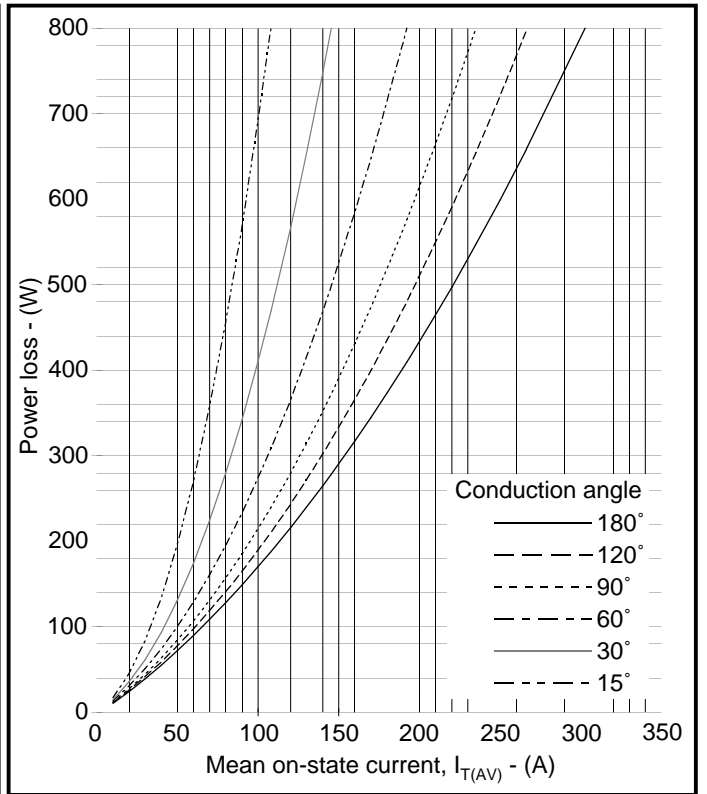

Fig.5 Sine wave power dissipation curves

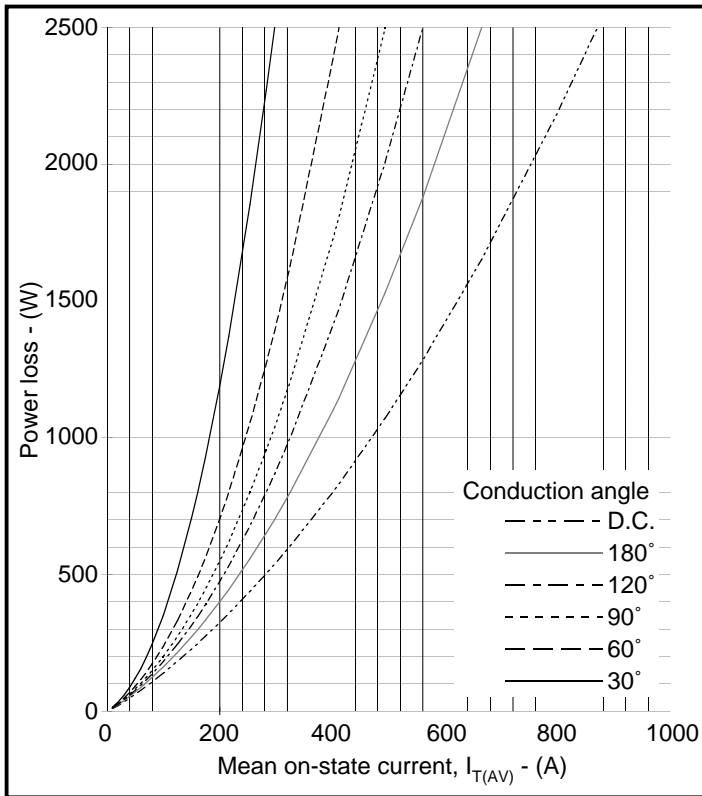

Fig.6 Square wave power dissipation curves

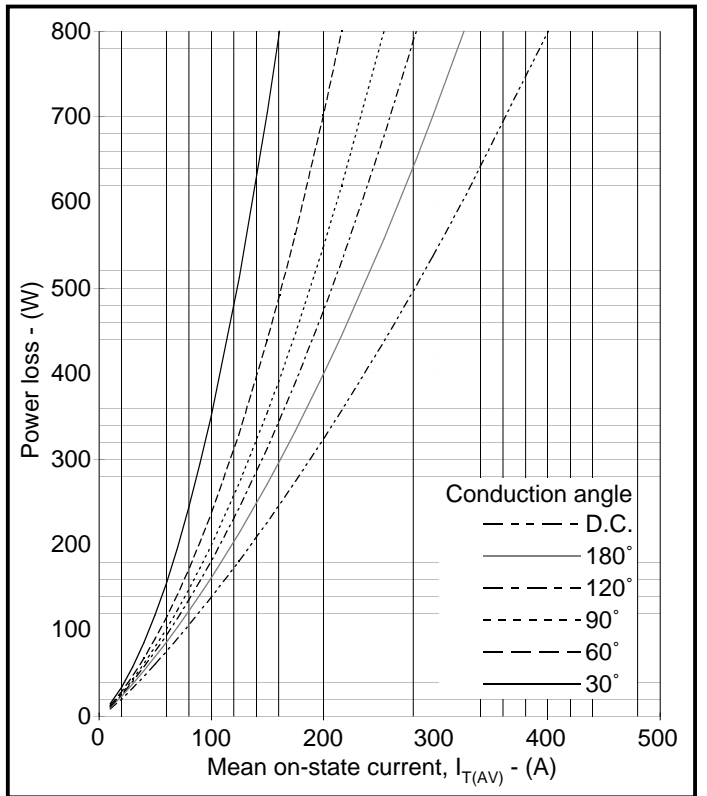
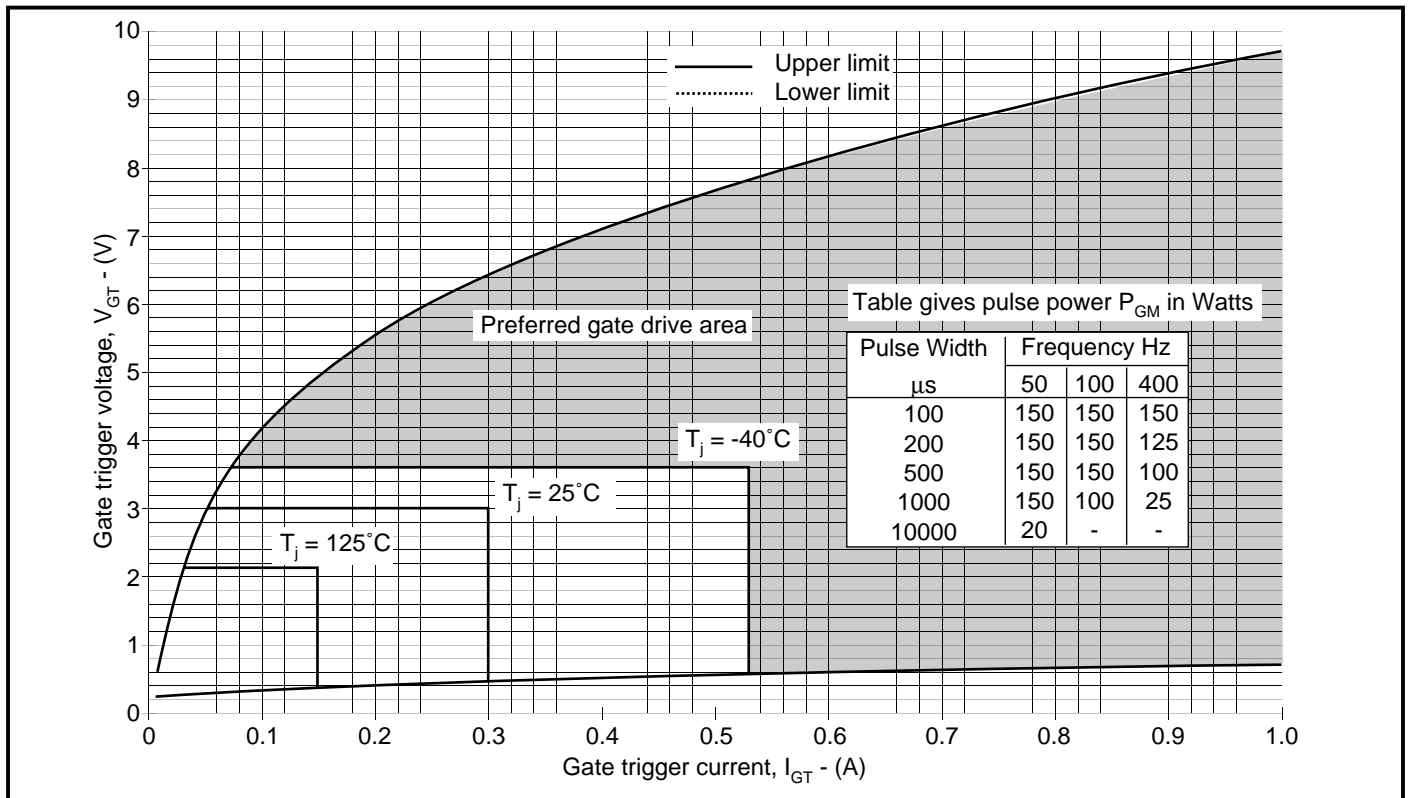
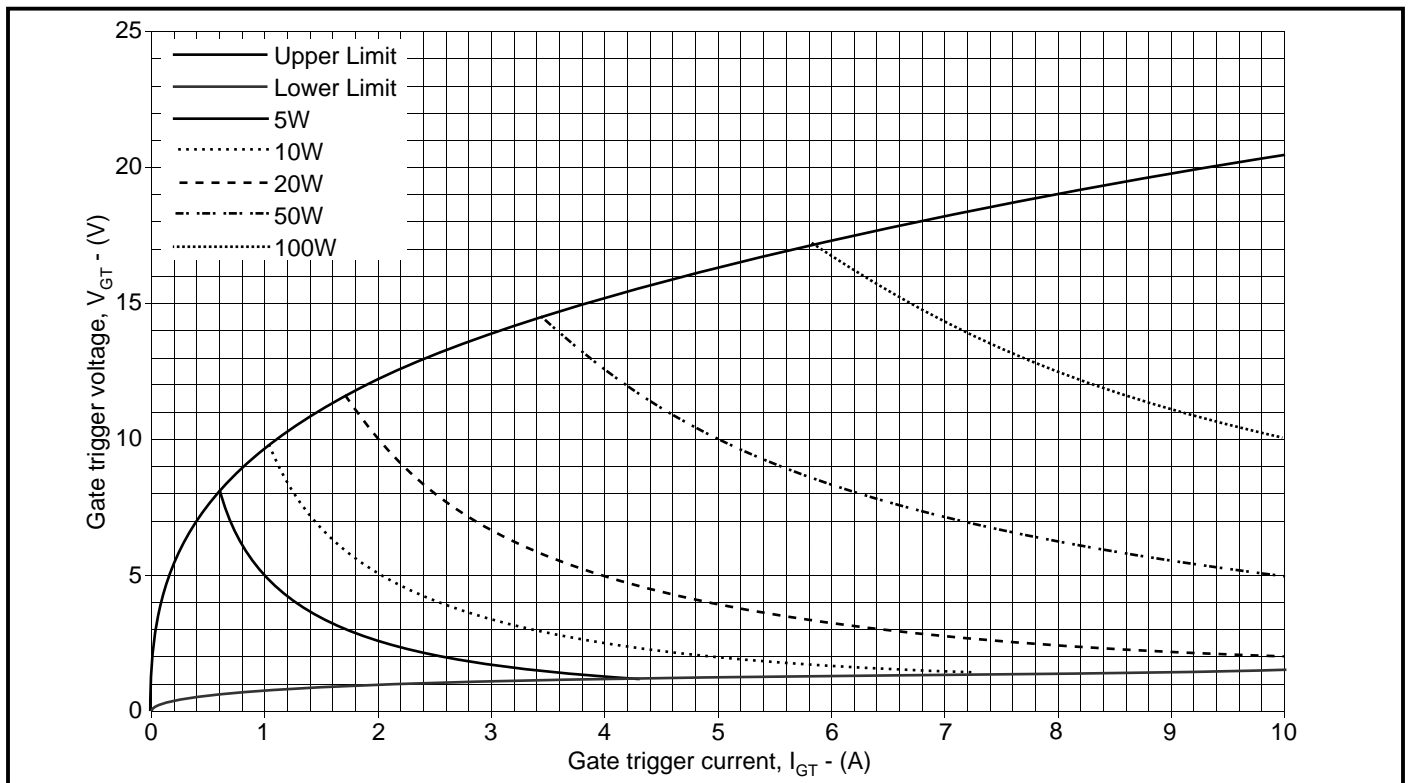

Fig.7 Square wave power dissipation curves



**Fig.8 Gate characteristics**



**Fig.9 Gate characteristics**

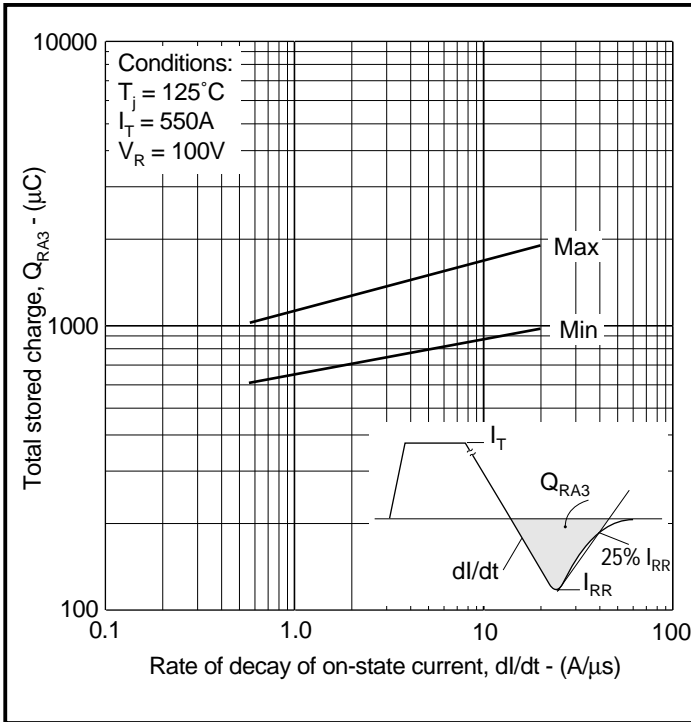

Fig.10 Stored charge

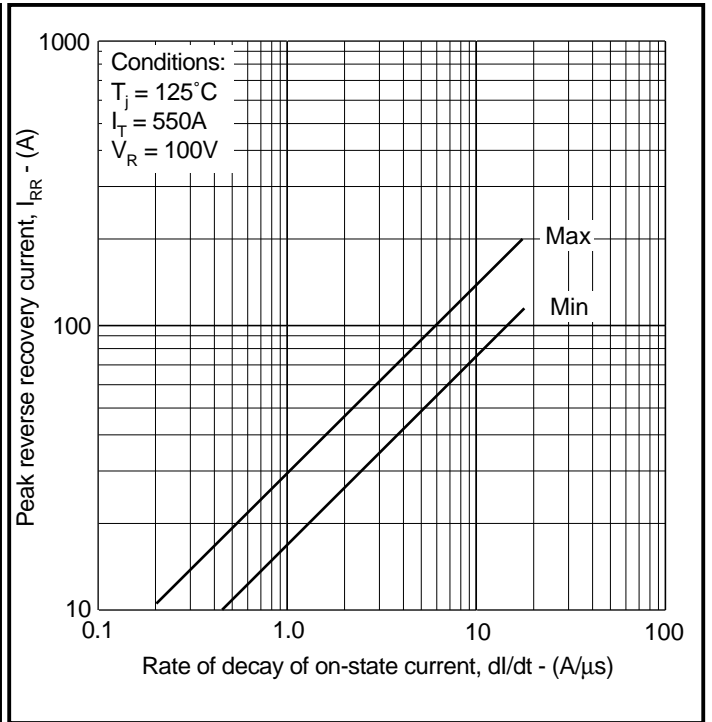

Fig.11 Reverse recovery current

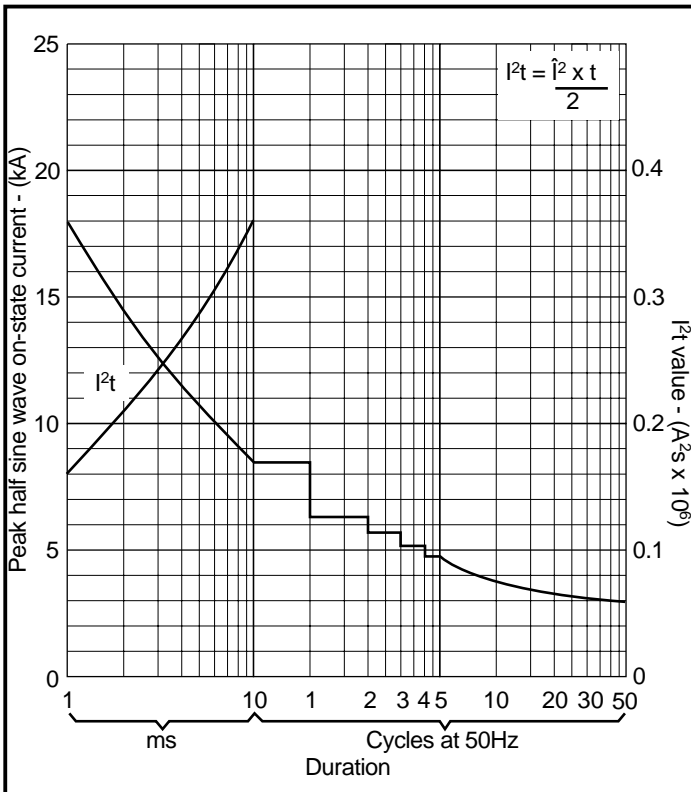

Fig.12 Surge (non-repetitive) on-state current vs time (with 50%  $V_{RRM}$  @  $T_{case} = 125^\circ\text{C}$ )

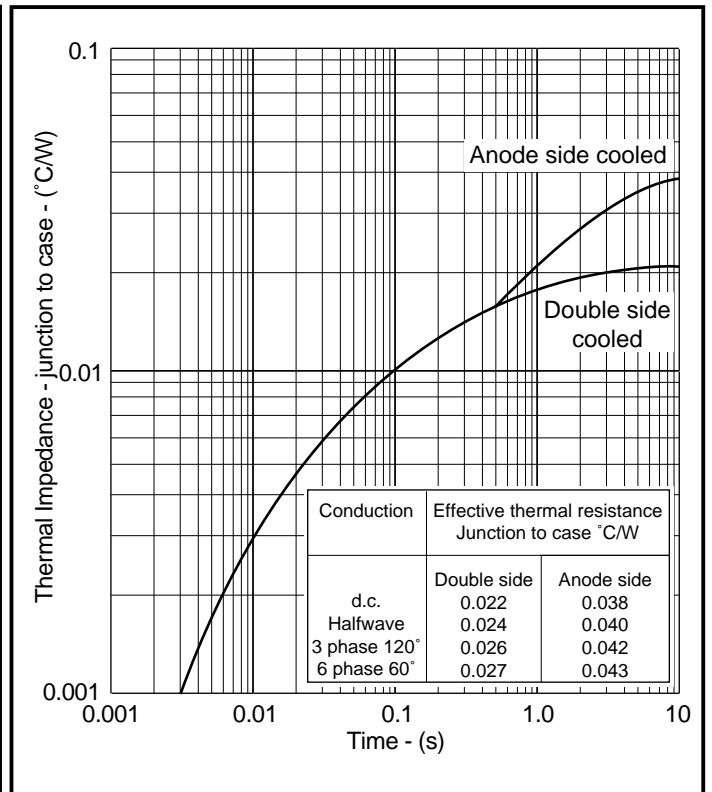
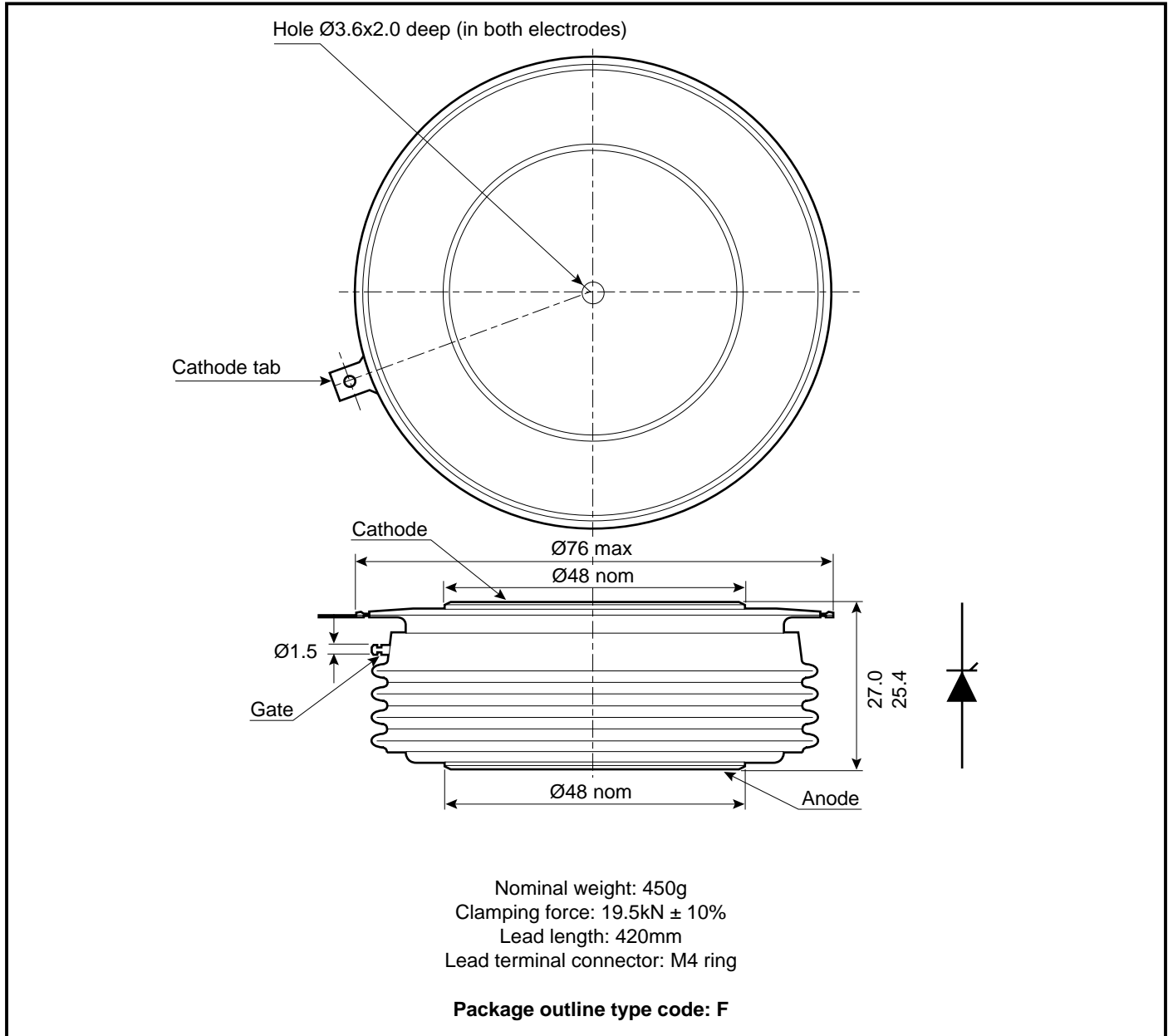

Fig.13 Transient thermal impedance - junction to case



**PACKAGE DETAILS**

For further package information, please contact your nearest Customer Service Centre. All dimensions in mm, unless stated otherwise. DO NOT SCALE.



## POWER ASSEMBLY CAPABILITY

The Power Assembly group was set up to provide a support service for those customers requiring more than the basic semiconductor, and has developed a flexible range of heatsink and clamping systems in line with advances in device voltages and current capability of our semiconductors.

We offer an extensive range of air and liquid cooled assemblies covering the full range of circuit designs in general use today. The Assembly group continues to offer high quality engineering support dedicated to designing new units to satisfy the growing needs of our customers.

Using the latest CAD methods our team of design and applications engineers aim to provide the Power Assembly Complete Solution (PACs).

## DEVICE CLAMPS

Disc devices require the correct clamping force to ensure their safe operation. The PACS range includes a varied selection of pre-loaded clamps to suit all of our manufactured devices. Types available include cube clamps for single side cooling of 'T' 23mm and 'E' 30mm discs, and bar clamps right up to 83kN for our 'Z' 100mm thyristors and diodes.

Clamps are available for single or double side cooling, with high insulation versions for high voltage assemblies.

Please refer to our application note on device clamping, AN4839

## HEATSINKS

The Power Assembly group has its own proprietary range of extruded aluminium heatsinks. They have been designed to optimise the performance of Dynex semiconductors. Data with respect to air natural, forced air and liquid cooling (with flow rates) is available on request.

For further information on device clamps, heatsinks and assemblies, please contact your nearest sales representative or customer service office.



<http://www.dynexsemi.com>

e-mail: [power\\_solutions@dynexsemi.com](mailto:power_solutions@dynexsemi.com)

**HEADQUARTERS OPERATIONS**  
**DYNEX SEMICONDUCTOR LTD**  
 Doddington Road, Lincoln.  
 Lincolnshire. LN6 3LF. United Kingdom.  
 Tel: 00-44-(0)1522-500500  
 Fax: 00-44-(0)1522-500550

**DYNEX POWER INC.**  
 99 Bank Street, Suite 410,  
 Ottawa, Ontario, Canada, K1P 6B9  
 Tel: 613.723.7035  
 Fax: 613.723.1518  
 Toll Free: 1.888.33.DYNEX (39639)

**CUSTOMER SERVICE CENTRES**  
**Mainland Europe** Tel: +33 (0)1 58 04 91 00. Fax: +33 (0)1 46 38 51 33  
**North America** Tel: (613) 723-7035. Fax: (613) 723-1518.  
**UK, Scandinavia & Rest Of World** Tel: +44 (0)1522 500500. Fax: +44 (0)1522 500020

**SALES OFFICES**  
**Mainland Europe** Tel: +33 (0)1 58 04 91 00. Fax: +33 (0)1 46 38 51 33  
**North America** Tel: (613) 723-7035. Fax: (613) 723-1518. Toll Free: 1.888.33.DYNEX (39639) /  
 Tel: (949) 733-3005. Fax: (949) 733-2986.  
**UK, Scandinavia & Rest Of World** Tel: +44 (0)1522 500500. Fax: +44 (0)1522 500020

These offices are supported by Representatives and Distributors in many countries world-wide.  
 © Dynex Semiconductor 2001 Publication No. DS4245-5 Issue No. 5.0 July 2001  
 TECHNICAL DOCUMENTATION – NOT FOR RESALE. PRINTED IN UNITED KINGDOM

### Datasheet Annotations:

Dynex Semiconductor annotate datasheets in the top right hand corner of the front page, to indicate product status. The annotations are as follows:-

**Target Information:** This is the most tentative form of information and represents a very preliminary specification. No actual design work on the product has been started.

**Preliminary Information:** The product is in design and development. The datasheet represents the product as it is understood but details may change.

**Advance Information:** The product design is complete and final characterisation for volume production is well in hand.

**No Annotation:** The product parameters are fixed and the product is available to datasheet specification.

This publication is issued to provide information only which (unless agreed by the Company in writing) may not be used, applied or reproduced for any purpose nor form part of any order or contract nor to be regarded as a representation relating to the products or services concerned. No warranty or guarantee express or implied is made regarding the capability, performance or suitability of any product or service. The Company reserves the right to alter without prior notice the specification, design or price of any product or service. Information concerning possible methods of use is provided as a guide only and does not constitute any guarantee that such methods of use will be satisfactory in a specific piece of equipment. It is the user's responsibility to fully determine the performance and suitability of any equipment using such information and to ensure that any publication or data used is up to date and has not been superseded. These products are not suitable for use in any medical products whose failure to perform may result in significant injury or death to the user. All products and materials are sold and services provided subject to the Company's conditions of sale, which are available on request.

All brand names and product names used in this publication are trademarks, registered trademarks or trade names of their respective owners.