

Features

- Epitaxial Planar Die Construction
- Complementary NPN Types Available (DDTC)
- Built-In Biasing Resistors, R1≠R2
- **Lead Free Finish/RoHS Compliant (Note 2)**

Mechanical Data

- Case: SOT-523
- Case Material: Molded Plastic. UL Flammability Classification Rating 94V-0
- Moisture sensitivity: Level 1 per J-STD-020C
- Terminals: Solderable per MIL-STD-202, Method 208
- Lead Free Plating (Matte Tin Finish annealed over Alloy 42 leadframe).
- Terminal Connections: See Diagram
- Marking: Date Code and Marking Code (See Diagrams & Page 3)
- Weight: 0.002 grams (approx.)
- Ordering Information (See Page 2)

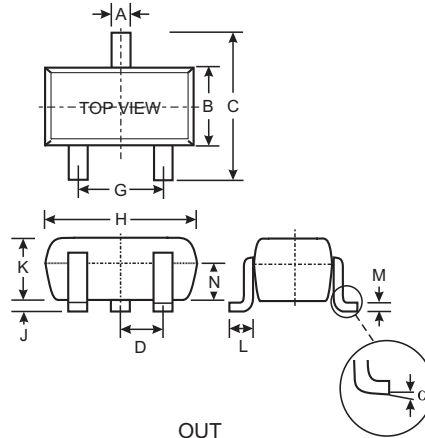

SOT-523			
Dim	Min	Max	Typ
A	0.15	0.30	0.22
B	0.75	0.85	0.80
C	1.45	1.75	1.60
D	—	—	0.50
G	0.90	1.10	1.00
H	1.50	1.70	1.60
J	0.00	0.10	0.05
K	0.60	0.80	0.75
L	0.10	0.30	0.22
M	0.10	0.20	0.12
N	0.45	0.65	0.50
α	0°	8°	—

All Dimensions in mm

P/N	R1 (NOM)	R2 (NOM)	MARKING
DDTA113ZE	1KΩ	10KΩ	P02
DDTA123YE	2.2KΩ	10KΩ	P05
DDTA123JE	2.2KΩ	47KΩ	P06
DDTA143XE	4.7KΩ	10KΩ	P09
DDTA143FE	4.7KΩ	22KΩ	P10
DDTA143ZE	4.7KΩ	47KΩ	P11
DDTA114YE	10KΩ	47KΩ	P14
DDTA114WE	10KΩ	4.7KΩ	P15
DDTA124XE	22KΩ	47KΩ	P18
DDTA144VE	47KΩ	10KΩ	P21
DDTA144WE	47KΩ	22KΩ	P22

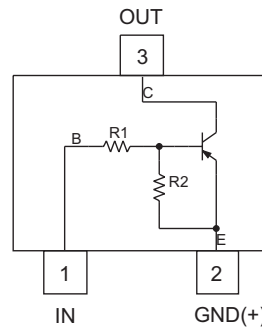

Schematic and Pin Configuration

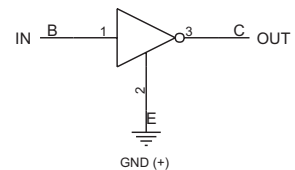

Equivalent Inverter Circuit

Maximum Ratings @ T_A = 25°C unless otherwise specified

Characteristic	Symbol	Value	Unit
Supply Voltage, (2) to (3)	V _{CC}	-50	V
Input Voltage, (1) to (2)	V _{IN}	+5 to -10 +5 to -12 +5 to -12 +7 to -20 +6 to -30 +5 to -30 +6 to -40 +10 to -30 +10 to -40 +15 to -40 +10 to -40	V
Output Current	I _O	-100 -100 -100 -100 -100 -100 -70 -100 -50 -30 -30	mA
Output Current	I _C (Max)	-100	mA
Power Dissipation	P _d	150	mW
Thermal Resistance, Junction to Ambient Air (Note 1)	R _{θJA}	833	°C/W

Note: 1. Mounted on FR4 PC Board with recommended pad layout at <http://www.diodes.com/datasheets/ap02001.pdf>.
2. No purposefully added lead.

Electrical Characteristics @ T_A = 25°C unless otherwise specified

Characteristic		Symbol	Min	Typ	Max	Unit	Test Condition
Input Voltage	DDTA113ZE DDTA123YE DDTA123JE DDTA143XE DDTA143FE DDTA143ZE DDTA114YE DDTA114WE DDTA124XE DDTA144VE DDTA144WE	V _{I(off)}	-0.3 -0.3 -0.5 -0.3 -0.3 -0.5 -0.3 -0.8 -0.4 -1.0 -0.8	—	—	V	V _{CC} = 5V, I _O = 100μA
	DDTA113ZE DDTA123YE DDTA123JE DDTA143XE DDTA143FE DDTA143ZE DDTA114YE DDTA114WE DDTA124XE DDTA144VE DDTA144WE	V _{I(on)}	—	—	-3.0 -3.0 -1.1 -2.5 -1.3 -1.3 -1.4 -3.0 -2.5 -5.0 -4.0		
Output Voltage		V _{O(on)}	—	-0.1	-0.3	V	I _O /I _I = -5mA/-0.25mA DDTA123E I _O /I _I = -5mA/-0.25mA DDTA143E I _O /I _I = -5mA/-0.25mA DDTA114E I _O /I _I = -10mA/-0.5mA All Others
Input Current	DDTA113ZE DDTA123YE DDTA123JE DDTA143XE DDTA143FE DDTA143ZE DDTA114YE DDTA114WE DDTA124XE DDTA144VE DDTA144WE	I _I	—	—	-7.2 -3.8 -3.6 -1.8 -1.8 -1.8 -0.88 -0.88 -0.36 -0.16 -0.16	mA	V _I = -5V
Output Current		I _{O(off)}	—	—	-0.5	μA	V _{CC} = -50V, V _I = 0V
DC Current Gain	DDTA113ZE DDTA123YE DDTA123JE DDTA143XE DDTA143FE DDTA143ZE DDTA114YE DDTA114WE DDTA124XE DDTA144VE DDTA144WE	G _I	-33 -33 -80 -30 -68 -80 -68 -24 -68 -33 -56	—	—	—	V _O = -5V, I _O = -10mA
Input Resistor Tolerance		ΔR ₁	-30	—	+30	%	—
Resistance Ratio Tolerance		ΔR ₂ /R ₁	-20	—	+20	%	—
Gain-Bandwidth Product*		f _T	—	250	—	MHz	V _{CE} = -10V, I _E = 5mA, f = 100MHz

* Transistor - For Reference Only

Ordering Information (Note 3)

Device	Packaging	Shipping
DDTA113ZE-7-F	SOT-523	3000/Tape & Reel
DDTA123YE-7-F	SOT-523	3000/Tape & Reel
DDTA123JE-7-F	SOT-523	3000/Tape & Reel
DDTA143XE-7-F	SOT-523	3000/Tape & Reel
DDTA143FE-7-F	SOT-523	3000/Tape & Reel
DDTA143ZE-7-F	SOT-523	3000/Tape & Reel
DDTA114YE-7-F	SOT-523	3000/Tape & Reel
DDTA114WE-7-F	SOT-523	3000/Tape & Reel
DDTA124XE-7-F	SOT-523	3000/Tape & Reel
DDTA144VE-7-F	SOT-523	3000/Tape & Reel
DDTA144WE-7-F	SOT-523	3000/Tape & Reel

Notes: 3. For Packaging Details, go to our website at <http://www.diodes.com/datasheets/ap02007.pdf>.

Marking Information

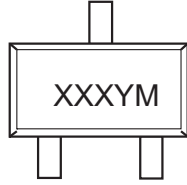

XXX = Product Type Marking Code (See Page 1, e.g. P02 = DDTA113ZE)
 YM = Date Code Marking
 Y = Year ex: T = 2006
 M = Month ex: 9 = September

Date Code Key

Year	2006	2007	2008	2009
Code	T	U	V	W

Month	Jan	Feb	Mar	Apr	May	Jun	Jul	Aug	Sep	Oct	Nov	Dec
Code	1	2	3	4	5	6	7	8	9	O	N	D

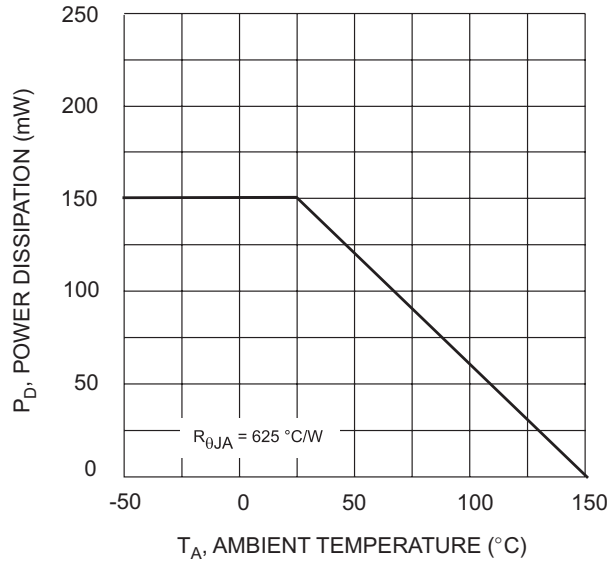

Fig. 1 Derating Curve

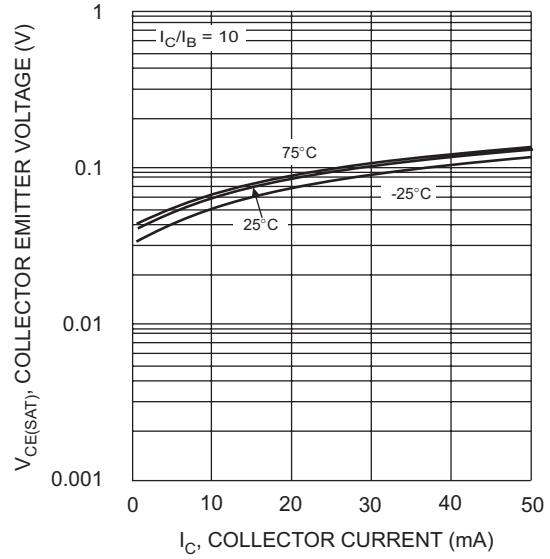

Fig. 2 $V_{CE(SAT)}$ vs. I_C

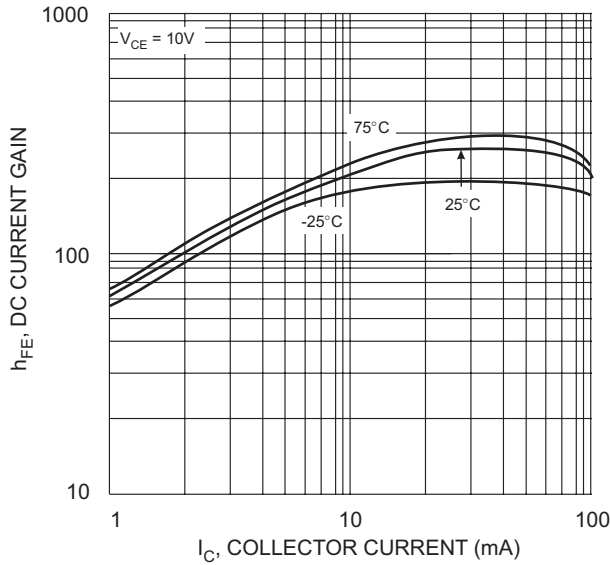

Fig. 3 DC Current Gain

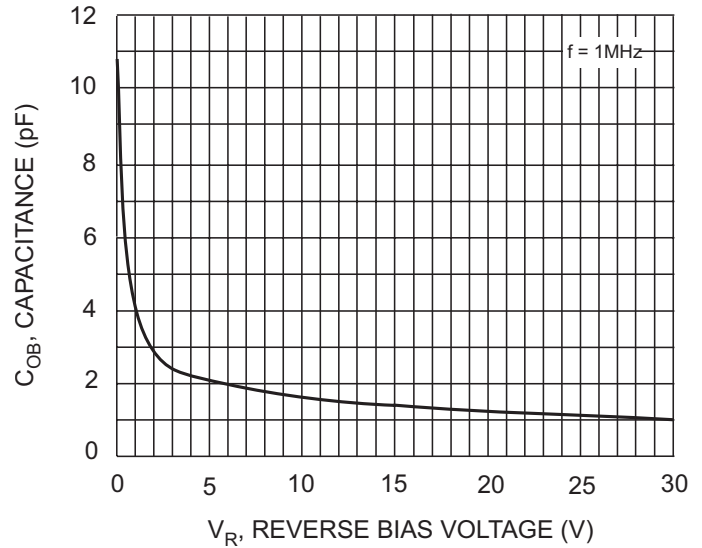

Fig. 4 Output Capacitance

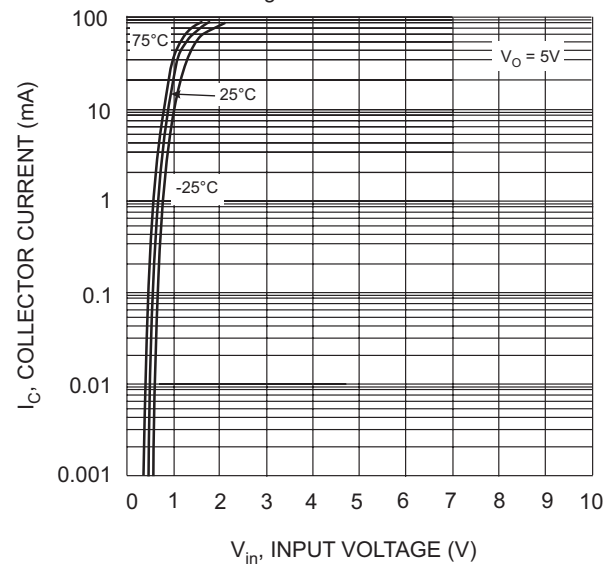

Fig. 5 Collector Current Vs. Input Voltage

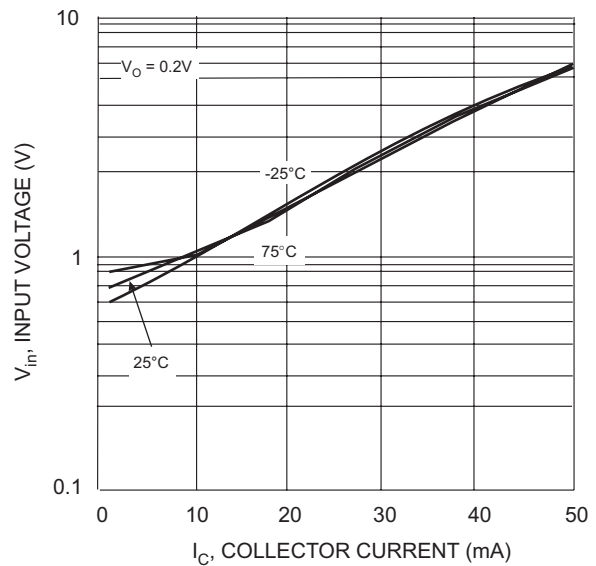

Fig. 6 Input Voltage vs. Collector Current

IMPORTANT NOTICE

Diodes Incorporated and its subsidiaries reserve the right to make modifications, enhancements, improvements, corrections or other changes without further notice to any product herein. Diodes Incorporated does not assume any liability arising out of the application or use of any product described herein; neither does it convey any license under its patent rights, nor the rights of others. The user of products in such applications shall assume all risks of such use and will agree to hold Diodes Incorporated and all the companies whose products are represented on our website, harmless against all damages.

LIFE SUPPORT

Diodes Incorporated products are not authorized for use as critical components in life support devices or systems without the expressed written approval of the President of Diodes Incorporated.