

# RED LASER DIODE



## DL-3107-165

Ver.1 Apr. 2001

### Features

- Short wavelength : 650 nm (Typ.)
- Low threshold current :  $I_{th} = 25\text{mA}$  (Typ.)
- High operating temperature : 5 mW at 70°C
- Frame type

### Applications

- DVD-AV, DVD-ROM

### Absolute Maximum Ratings

( $T_c=25^\circ\text{C}$ )

Parameter	Symbol	Ratings	Unit	
Light Output	CW	$P_o$	7	mW
Reverse Voltage	Laser	VR	2	V
	PD		30	
Operating Temperature	$T_{opr}$	-10 ~ +70	°C	
Storage Temperature	$T_{stg}$	-40 ~ +85	°C	

### Electrical and Optical Characteristics <sup>1) 2)</sup>

( $T_c=25^\circ\text{C}$ )

Parameter	Symbol	Condition	Min.	Typ.	Max.	Unit	
Threshold Current	$I_{th}$	CW	-	20	40	mA	
Operating Current	$I_{op}$	$P_o=5\text{mW}$	-	30	50	mA	
Operating Voltage	$V_{op}$	$P_o=5\text{mW}$	-	2.3	2.6	V	
Lasing Wavelength	$\lambda_p$	$P_o=5\text{mW}$	650	655	665	nm	
Beam <sup>3)</sup> Divergence	Perpendicular	$Q_v$	$P_o=5\text{mW}$	25	30	35	°
	Parallel	$Q_h$	$P_o=5\text{mW}$	7.0	8.0	10	°
Off Axis Angle	Perpendicular	$dQ_v$	-	-	$\pm 3$	°	
	Parallel	$dQ_h$	-	-	$\pm 2$	°	
Differential Efficiency	$dP_o/dI_{op}$	-	0.3	0.5	0.8	mW/mA	
Monitoring Output Current	$I_m$	$P_o=5\text{mW}$	0.05	0.1	0.3	mA	
Astigmatism	$A_s$	$P_o=5\text{mW}$	-	8	-	$\mu\text{m}$	

1) Initial values 2) All the above values are evaluated with Tottori Sanyo's measuring apparatus 3) Full angle at half maximum

Note : The above product specification are subject to change without notice.

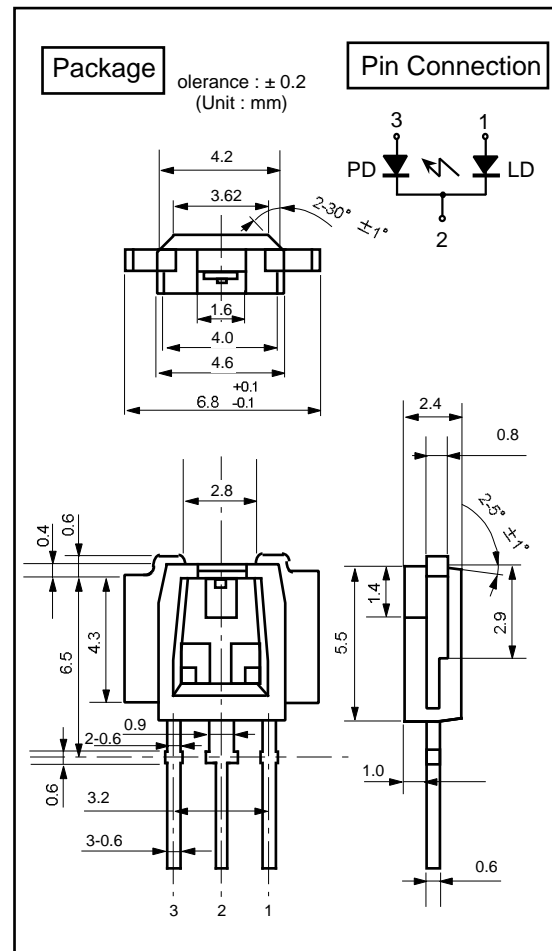

Tottori SANYO Electric Co., Ltd. Electronic Device Business Headquarters  
LED Division

5-318, Tachikawa, Tottori 680-8634 Japan TEL : +81-857-21-2137 FAX : +81-857-21-2161

## Characteristics

**Output power vs. Forward current**

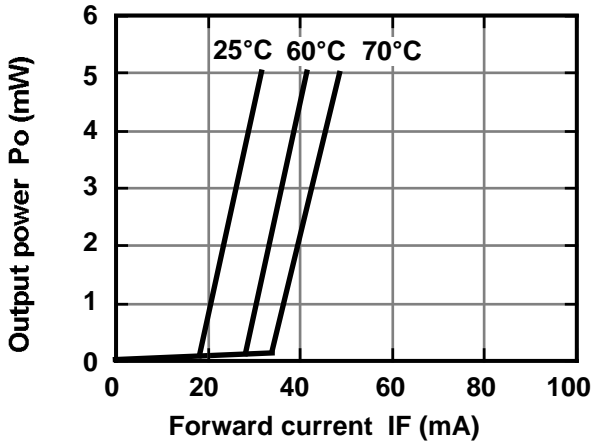

**Threshold current vs. Temperature**

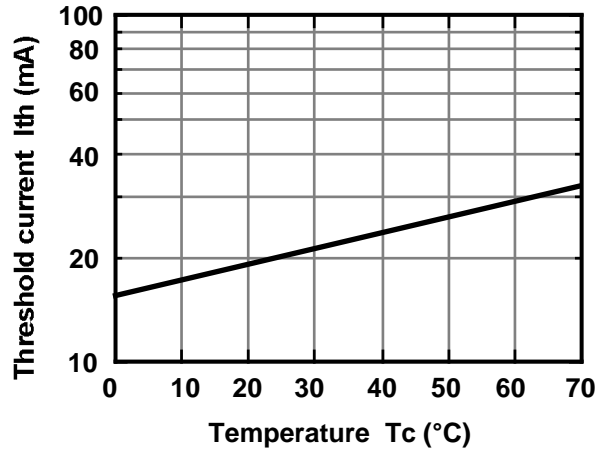

**Monitoring current vs. Output power**

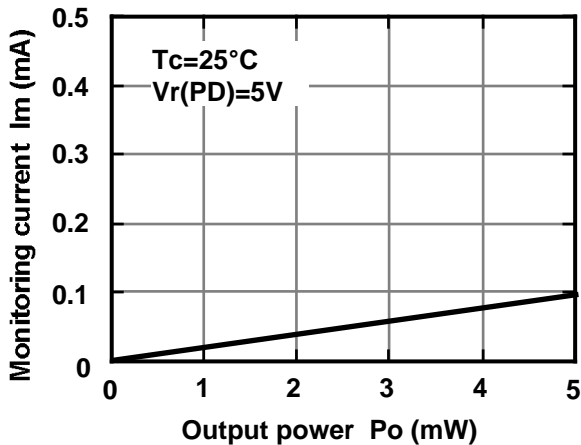

**Beam divergence**

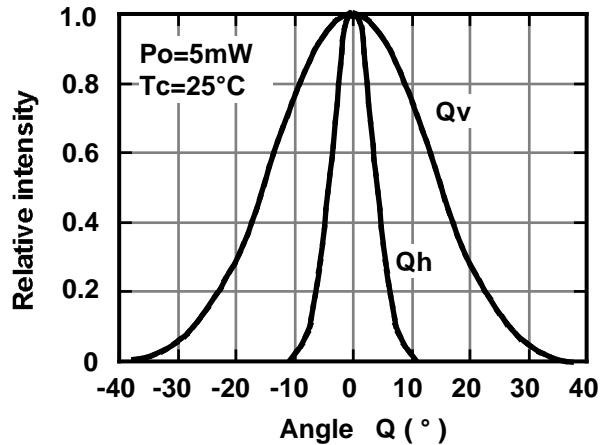

**Lasing wavelength vs. Temperature**

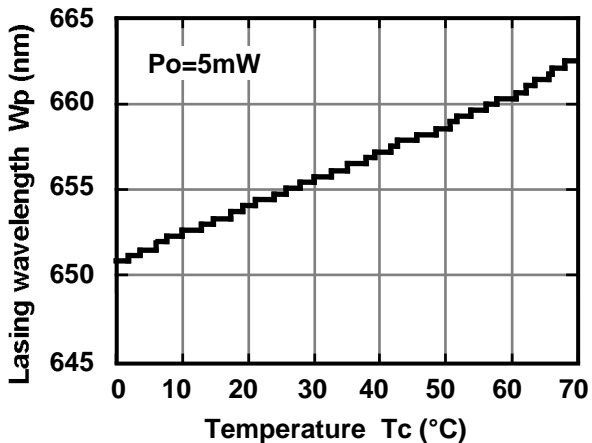

**Lasing wavelength vs. Output power**

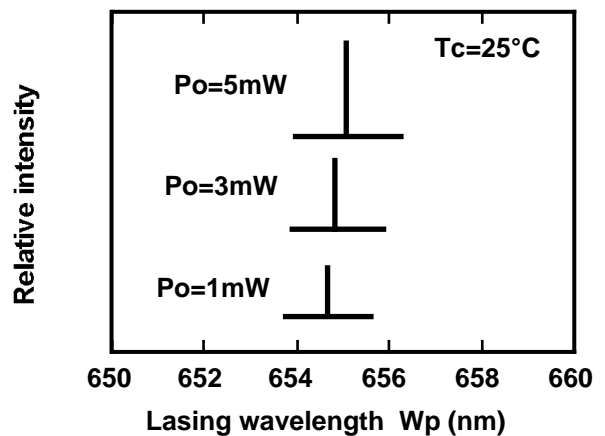

This is typical data and it may not represent all products.