

DM54LS259/DM74LS259 8-Bit Addressable Latches

General Description

These 8-bit addressable latches are designed for general purpose storage applications in digital systems. Specific uses include working registers, serial-holding registers, and active-high decoders or demultiplexers. They are multifunctional devices capable of storing single-line data in eight addressable latches, and being a 1-of-8 decoder or demultiplexer with active-high outputs.

Four distinct modes of operation are selectable by controlling the clear and enable inputs as enumerated in the function table. In the addressable-latch mode, data at the data-in terminal is written into the addressed latch. The addressed latch will follow the data input with all unaddressed latches remaining in their previous states. In the memory mode, all latches remain in their previous states and are unaffected by the data or address inputs. To eliminate the possibility of entering erroneous data in the latches, the enable should be held high (inactive) while the address lines are changing. In the 1-of-8 decoding or demultiplexing mode, the addressed output will follow the level of the D input with all other outputs low. In the clear mode, all outputs are low and unaffected by the address and data inputs.

Features

- 8-Bit parallel-out storage register performs serial-to-parallel conversion with storage
- Asynchronous parallel clear
- Active high decoder
- Enable/disable input simplifies expansion
- Direct replacement for Fairchild 9334
- Expandable for N-bit applications
- Four distinct functional modes
- Typical propagation delay times:
 - Enable-to-output 18 ns
 - Data-to-output 16 ns
 - Address-to-output 21 ns
 - Clear-to-output 17 ns
- Fan-out
 - I_{OL} (sink current)
 - 54LS259 4 mA
 - 74LS259 8 mA
 - I_{OH} (source current) -0.4 mA
- Typical I_{CC} 22 mA

Connection Diagram

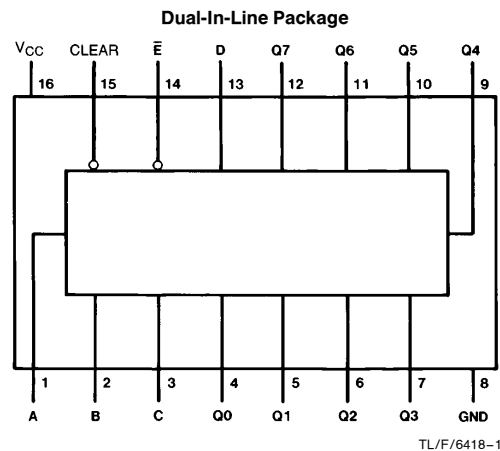

Order Number DM54LS259E, DM54LS259J,
DM54LS259W, DM74LS259M,
DM74LS259WM or DM74LS259N
See NS Package Number E20A, J16A,
M16A, M16B, N16E or W16A

Function Table

Inputs		Output of Addressed Latch	Each Other Output	Function
Clear	\bar{E}			
H	L	D	Q_{i0}	Addressable Latch
H	H	Q_{i0}	Q_{i0}	Memory
L	L	D	L	8-Line Demultiplexer
L	H	L	L	Clear

Latch Selection Table

Select Inputs			Latch Addressed
C	B	A	
L	L	L	0
L	L	H	1
L	H	L	2
L	H	H	3
H	L	L	4
H	L	H	5
H	H	L	6
H	H	H	7

H = High Level, L = Low Level

D = the Level of the Data Input

Q_{i0} = the Level of Q_i ($i = 0, 1, \dots, 7$, as Appropriate) before the Indicated Steady-State Input Conditions Were Established.

Absolute Maximum Ratings (Note)

If Military/Aerospace specified devices are required, please contact the National Semiconductor Sales Office/Distributors for availability and specifications.

Supply Voltage	7V
Input Voltage	7V
Operating Free Air Temperature Range	
DM54	−55°C to +125°C
DM74LS	0°C to +70°C
Storage Temperature Range	−65°C to +150°C

Note: The "Absolute Maximum Ratings" are those values beyond which the safety of the device cannot be guaranteed. The device should not be operated at these limits. The parametric values defined in the "Electrical Characteristics" table are not guaranteed at the absolute maximum ratings. The "Recommended Operating Conditions" table will define the conditions for actual device operation.

Recommended Operating Conditions

Symbol	Parameter		DM54LS259			DM74LS259			Units
			Min	Nom	Max	Min	Nom	Max	
V _{CC}	Supply Voltage		4.5	5	5.5	4.75	5	5.25	V
V _{IH}	High Level Input Voltage		2			2			V
V _{IL}	Low Level Input Voltage				0.7			0.8	V
I _{OH}	High Level Output Current				−0.4			−0.4	mA
I _{OL}	Low Level Output Current				4			8	mA
t _W	Pulse Width (Note 7)	Enable	17			15			ns
		Clear	17			15			
t _{SU}	Setup Time (Notes 1, 2, 3 & 7)	Data	20 ↑			15 ↑			ns
		Select	15 ↓			15 ↓			
t _H	Hold Time (Notes 1, 2 & 7)	Data	5 ↑			2.5 ↑			ns
		Select	0 ↑			2.5 ↑			
T _A	Free Air Operating Temperature		−55		125	0		70	°C

Electrical Characteristics over recommended operating free air temperature range (unless otherwise noted)

Symbol	Parameter	Conditions	Min	Typ (Note 4)	Max	Units	
V _I	Input Clamp Voltage	V _{CC} = Min, I _I = −18 mA			−1.5	V	
V _{OH}	High Level Output Voltage	V _{CC} = Min, I _{OH} = Max	DM54	2.5		V	
		V _{IL} = Max, V _{IH} = Min	DM74	2.7	3.4		
V _{OL}	Low Level Output Voltage	V _{CC} = Min, I _{OL} = Max	DM54		0.4	V	
		V _{IL} = Max, V _{IH} = Min	DM74		0.35		
		I _{OL} = 4 mA, V _{CC} = Min	DM74		0.25		0.4
I _I	Input Current @ Max Input Voltage	V _{CC} = Max, V _I = 7V	DM74		0.1	mA	
		V _I = 10V	DM54				
I _{IH}	High Level Input Current	V _{CC} = Max, V _I = 2.7V			20	μA	
I _{IL}	Low Level Input Current	V _{CC} = Max, V _I = 0.4V			−0.4	mA	
	Enable	V _{CC} = Max, V _I = 0.4V			−0.8		
I _{OS}	Short Circuit Output Current	V _{CC} = Max (Note 5)	DM54	−20		−100	mA
			DM74	−20		−100	
I _{CC}	Supply Current	V _{CC} = Max (Note 6)		22	36	mA	

Note 1: The symbols (↓, ↑) indicate the edge of the clock pulse used for reference: ↑ for rising edge, ↓ for falling edge.

Note 2: Setup and hold times are with reference to the enable input.

Note 3: The select-to-enable setup time is the time before the High-to-Low enable transition that the select must be stable so that the correct latch is selected and the others not affected.

Note 4: All typicals are at V_{CC} = 5V, T_A = 25°C.

Note 5: Not more than one output should be shorted at a time, and the duration should not exceed one second.

Note 6: I_{CC} is measured with all inputs at 4.5V, and all outputs open.

Note 7: T_A = 25°C and V_{CC} = 5V.

Switching Characteristics at $V_{CC} = 5V$ and $T_A = 25^\circ C$

Symbol	Parameter	From (Input) To (Output)	DM54LS		DM74LS		Units
			$C_L = 15 \text{ pF}$		$C_L = 50 \text{ pF}$ $R_L = 2 \text{ k}\Omega$		
			Min	Max	Min	Max	
t_{PLH}	Propagation Delay Time Low to High Level Output	Enable to Output		27		38	ns
t_{PHL}	Propagation Delay Time High to Low Level Output	Enable to Output		24		32	ns
t_{PLH}	Propagation Delay Time Low to High Level Output	Data to Output		30		35	ns
t_{PHL}	Propagation Delay Time High to Low Level Output	Data to Output		20		30	ns
t_{PLH}	Propagation Delay Time Low to High Level Output	Select to Output		30		41	ns
t_{PHL}	Propagation Delay Time High to Low Level Output	Select to Output		29		38	ns
t_{PHL}	Propagation Delay Time High to Low Level Output	Clear to Output		18		36	ns

Physical Dimensions inches (millimeters)

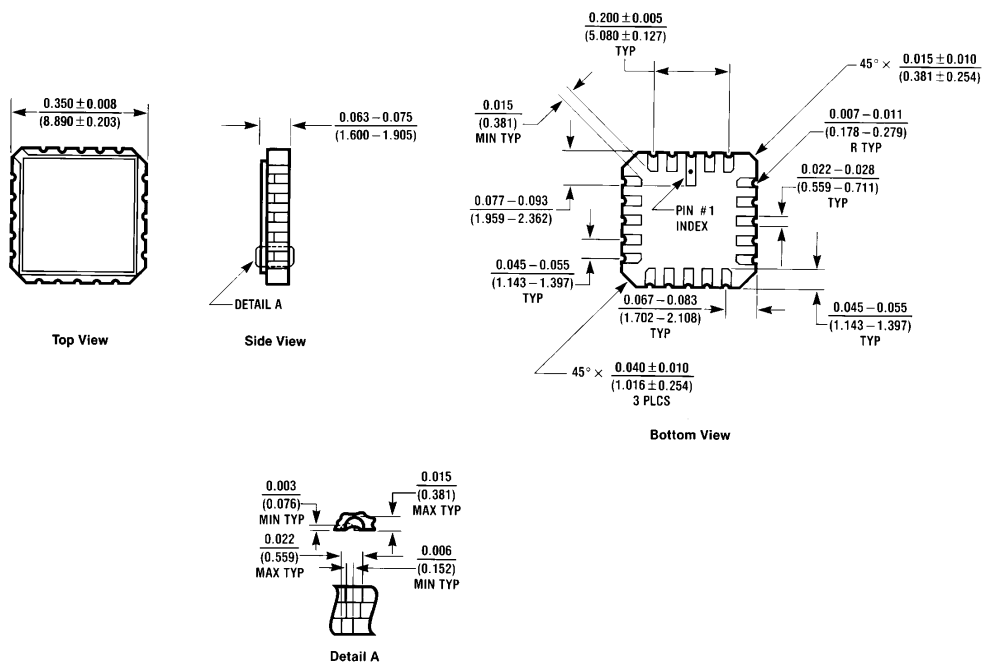

E20A (REV D)

Ceramic Leadless Chip Carrier (E)
Order Number DM54LS259E
NS Package Number E20A

Physical Dimensions inches (millimeters) (Continued)

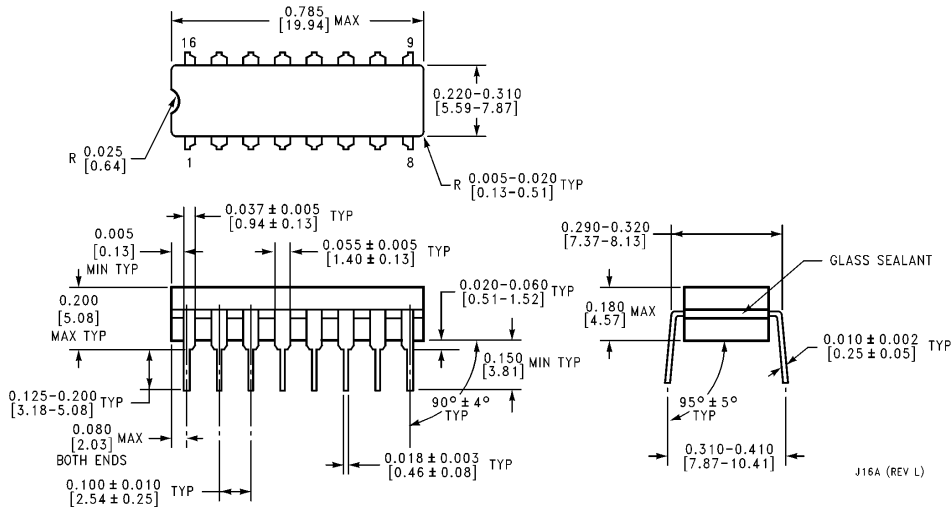

16-Lead Ceramic Dual-In-Line Package (J)
Order Number DM54LS259J
NS Package Number J16A

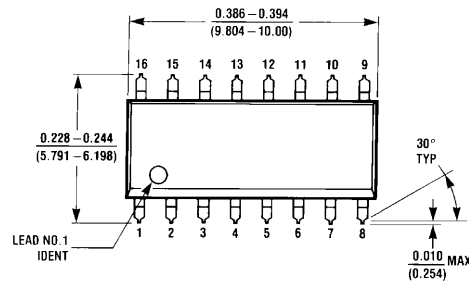

16-Lead Molded Package Small Outline (SO)
Order Number DM74LS259M
NS Package Number M16A

Physical Dimensions inches (millimeters) (Continued)

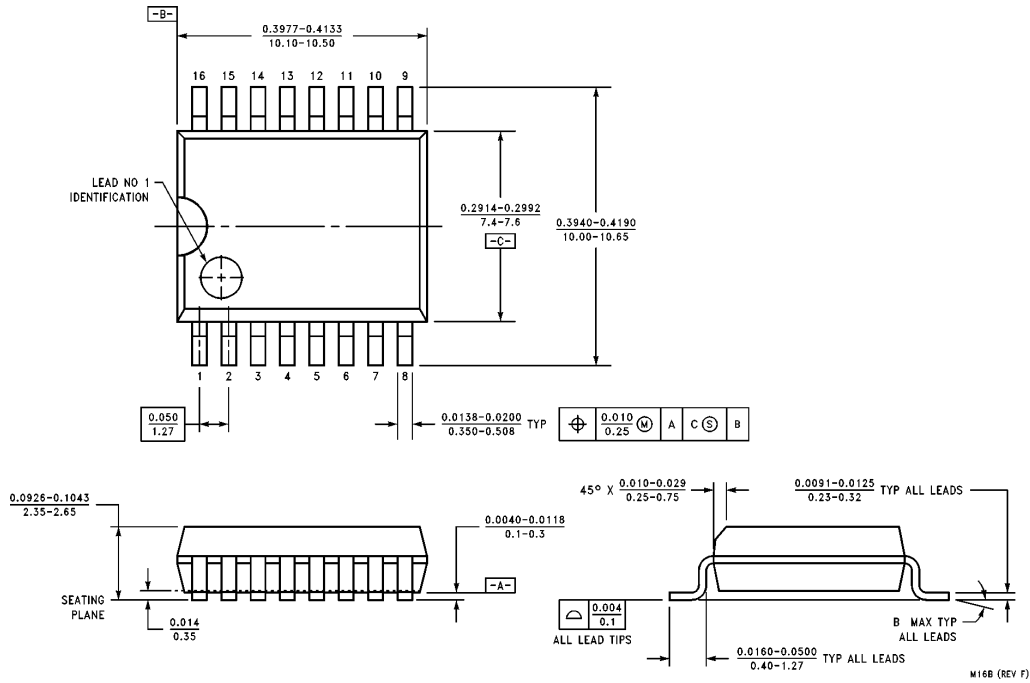

16-Lead Wide Small Outline Molded Package (M)
Order Number DM74LS259WM
NS Package Number M16B

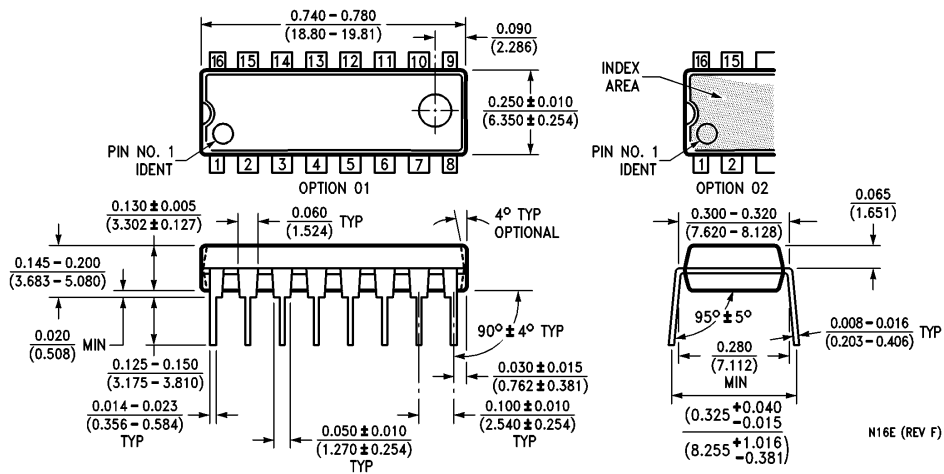

16-Lead Molded Dual-In-Line Package (N)
Order Number DM74LS259N
NS Package Number N16E

Physical Dimensions inches (millimeters) (Continued)

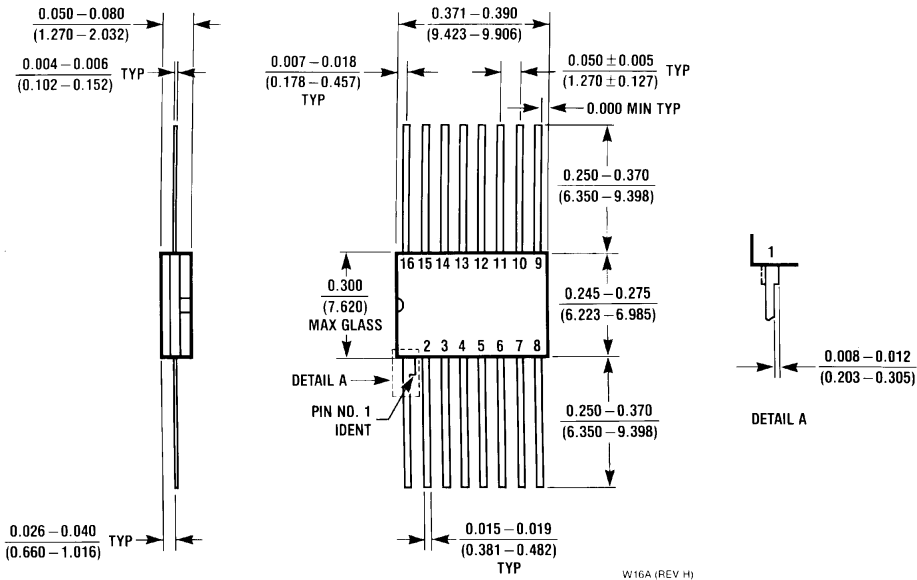

16-Lead Ceramic Flat Package (W)
Order Number DM54LS259W
NS Package Number W16A

W16A (REV. H)

LIFE SUPPORT POLICY

NATIONAL'S PRODUCTS ARE NOT AUTHORIZED FOR USE AS CRITICAL COMPONENTS IN LIFE SUPPORT DEVICES OR SYSTEMS WITHOUT THE EXPRESS WRITTEN APPROVAL OF THE PRESIDENT OF NATIONAL SEMICONDUCTOR CORPORATION. As used herein:

1. Life support devices or systems are devices or systems which, (a) are intended for surgical implant into the body, or (b) support or sustain life, and whose failure to perform, when properly used in accordance with instructions for use provided in the labeling, can be reasonably expected to result in a significant injury to the user.
2. A critical component is any component of a life support device or system whose failure to perform can be reasonably expected to cause the failure of the life support device or system, or to affect its safety or effectiveness.



National Semiconductor Corporation
 1111 West Bardin Road
 Arlington, TX 76017
 Tel: 1(800) 272-9959
 Fax: 1(800) 737-7018

National Semiconductor Europe
 Fax: (+49) 0-180-530 85 86
 Email: onjwge@tevm2.nsc.com
 Deutsch Tel: (+49) 0-180-530 85 85
 English Tel: (+49) 0-180-532 78 32
 Français Tel: (+49) 0-180-532 93 58
 Italiano Tel: (+49) 0-180-534 16 80

National Semiconductor Hong Kong Ltd.
 13th Floor, Straight Block,
 Ocean Centre, 5 Canton Rd.
 Tsimshatsui, Kowloon
 Hong Kong
 Tel: (852) 2737-1600
 Fax: (852) 2736-9960

National Semiconductor Japan Ltd.
 Tel: 81-043-299-2309
 Fax: 81-043-299-2408

National does not assume any responsibility for use of any circuitry described, no circuit patent licenses are implied and National reserves the right at any time without notice to change said circuitry and specifications.