

DS90C2501

Transmitter with built-in scaler for LVDS Display Interface (LDI)

General Description

The DS90C2501 is a highly integrated scaling IC with LVDS transmitter with a scaled resolution up to SXGA+ for single pixel input. The DS90C2501 is a video controller hub designed to be compatible with Graphic Memory Controller Hub (GMCH). The input interface can be single or dual DVO port (12 pin per port). The high quality cubic zoom engine scales the input graphics into the desired/optimal output resolution up to 1400x1050 resolution. Advanced video digital signal processing provides gamma correction, and dithering for the display output. A two-wire serial interface is used to communicate with the host system. The dual high speed LVDS channels supports single pixel in-single pixel out, single pixel in-dual pixel out, and dual pixel in-dual pixel out transmission modes. The DS90C2501 complies to Open LDI standard, and can be paired up with DS90CF388 receiver or FPD8531x/FPD8731x series integrated timing controller or FPDLink LVDS receivers such as DS90CF364/DS90CF384A/DS90CF384/DS90CF384A. The LVDS output is similar to DS90C387 and DS90C387R. Thus, this transmitter can be paired up with DS90CF388, receiver of 112MHz LDI chipset or FPD-Link Receivers in non-DC Balance mode operation which provides GUI/LCD panel/mother board vendors a wide choice of inter-operation with LVDS based TFT panels.

This chip is an ideal solution to solve EMI and cable size problems for high-resolution flat panel applications. It provides a reliable industry standard interface based on LVDS technology that delivers the bandwidth needed for high-resolution panels while maximizing bit times, and keeping clock rates low to reduce EMI and shielding requirements. For more details, please refer to the "Applications Information" section of this datasheet.

Features

- Complies with Open LDI and GMCH DVO specification for digital display interfaces
- 25 to 65 MHz clock in single pixel in to single pixel out operation.
- 50 to 130 MHz clock in single pixel in to dual pixel out operation.
- Support 24bit/48bit color TFT LCD with Conventional and Non-Conventional Color Mappings.
- Support 16bit/32bit color TFT LCD.
- Single pixel transmitter inputs support single pixel GUI interface.
- Up scaling/panel fitting supports VGA to SXGA+ output in single pixel input mode at 640x480@60Hz, 800x600@60Hz, 1024x768@60Hz, 1280x1024@60Hz, 1400x1050@60Hz.
- Independent horizontal and vertical scaling.
- Support dithering (available for 6-bit color only), programmable smoothing and anti-aliasing filter.
- Programmable digital sharpness, edge enhancement and contrast control via gamma correction.
- Allow 2% at 200KHz spread spectrum clocking, rejects cycle-to-cycle jitter (+/- 20% of input data bit time).
- Programmable LCD panel power sequencing.
- Support low voltage swing signal level (1V to 1.8V), 2.5V and 3.3V LVTTTL level on CLKINP, CLKINM, D0 to D23, DE, HSYNC and VSYNC pins
- Support 2.5V/3.3V LVTTTL level on configuration pins
- Support 3.3V LVTTTL level on GPIO pins
- Available in 10mm x 10mm x 1mm 128pin thermally enhanced CSP package.
- Two-wire serial communication interface is active during normal as well as power down mode and support data rates up to 400KHz.
- TIA/EIA-644, Open LDI, DVO compliance.

Block Diagram

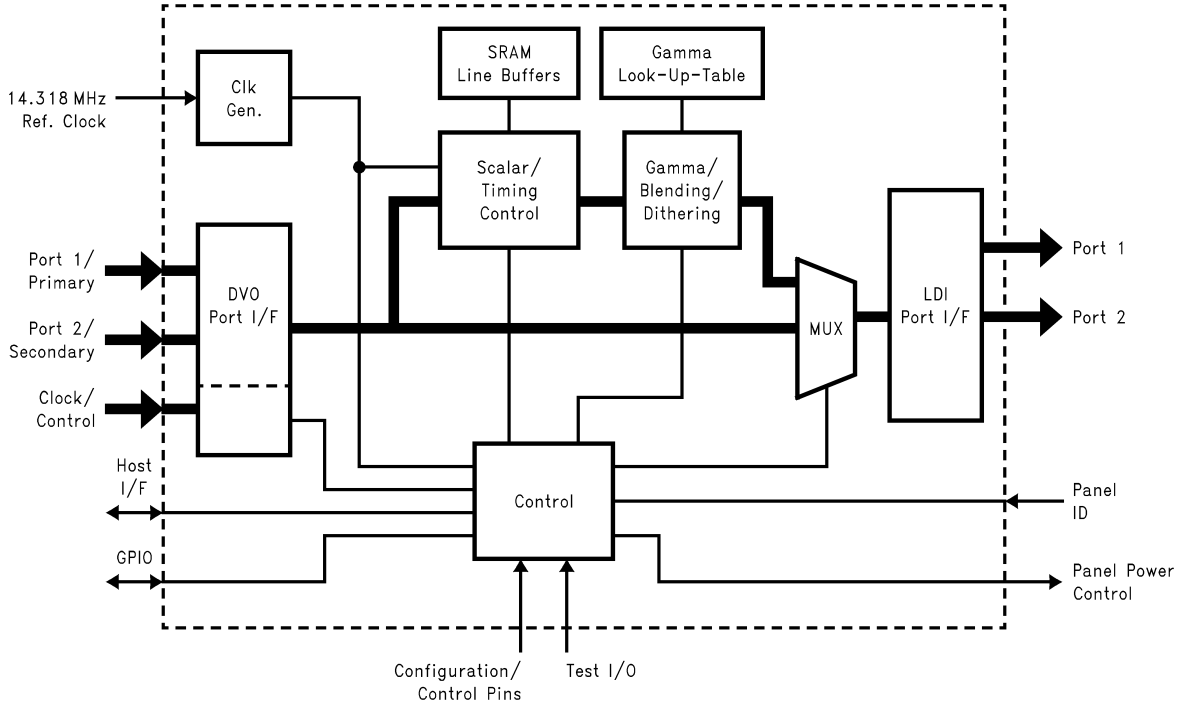

20004552

Absolute Maximum Ratings (Note 1)

If Military/Aerospace specified devices are required, please contact the National Semiconductor Sales Office/Distributors for availability and specifications.

Supply Voltage (V_{CC})	-0.3V to +2.8V
Supply Voltage (V_{CC3V})	-0.3V to +3.6V
CMOS/TTL Input Voltage	-0.3V to V_{CC3V}
CMOS/TTL Output Voltage	-0.3V to ($V_{CC} + 0.3V$)
LVDS Driver Output Voltage	-0.3V to ($V_{CC} + 0.3V$)
LVDS Output Short Circuit Duration	Continuous
Junction Temperature	+150°C
Storage Temperature	-65°C to +150°C
Lead Temperature (Soldering, 4 sec.)	+260°C

Typical Package Power Dissipation Capacity @ 70°C and Max V_{CC}

128 CSP Package:

DS90C2501 1.8W

Maximum Operating Case Temperature: 97°C (measured at top center of package)

ESD Rating:

DS90C2501

(HBM, 1.5kΩ, 100pF) > 2 kV

(EIAJ, 0Ω, 200pF) > 250 V

Recommended Operating Conditions

	Min	Nom	Max	Units
All Supply Voltage except (V_{CC3V})	2.250	2.5	2.750	V
V_{CC3V} Supply Voltage Operating Free Air Temperature (T_A)	3.0	3.3	3.6	V
Supply Noise Voltage (V_{CC}) up to 33Mhz	0	+25	+70	°C
			100	mV _{P-P}

DC Characteristics

Over recommended operating supply and temperature ranges unless otherwise specified.

Symbol	Parameter	Conditions	Min	Typ	Max	Units
LVC MOS/LVTTL DC SPECIFICATIONS (All input pins when operate in LVTTL level except DUAL pin. Note: On ID0, ID1 pins have typical 30K ohm internal pull-down, and ID2 and ID3 pins have typical 3K ohm internal pull-down.)						
V_{IH}	High Level Input Voltage	$V_{REF} = V_{CC3V}$	2.0		V_{CC3V}	V
V_{IL}	Low Level Input Voltage	$V_{REF} = V_{CC3V}$	-0.3		0.8	V
V_{CL}	Input Clamp Voltage	$I_{CL} = 18 \text{ mA}$		-0.9	-1.5	V
I_{IN}	Input Current	$V_{IN} = 0.4V, \text{ or } V_{CC}$		+1.8	+15	μA
		$V_{IN} = GND$	-15	0		μA
LVC MOS/LVTTL DC SPECIFICATIONS for DUAL pin, pin35						
$V_{IH \text{ DUAL}}$	High Level Input Voltage (for dual pixel in to dual pixel out).	$\overline{PD} = V_{CC3V}$	2.0		V_{CC}	V
$V_{IM \text{ DUAL}}$	High Level Input Voltage (for single pixel in to dual pixel out).	$\overline{PD} = V_{CC3V}$	$\frac{1}{2}V_{CC}-0.1$	$\frac{1}{2}V_{CC}$	$\frac{1}{2}V_{CC}+0.1$	V
$V_{IL \text{ DUAL}}$	High Level Input Voltage (for single pixel in to single pixel out).	$\overline{PD} = V_{CC3V}$	0		0.4	V
V_{CL}	Input Clamp Voltage	$I_{CL} = 18 \text{ mA}$		-0.9	-1.5	V
I_{IN}	Input Current	$V_{IN} = 0.4V, V_{CC}$		1.8	15	μA
		$V_{IN} = Gnd$	-15	0		μA
LVC MOS/LVTTL DC SPECIFICATIONS for MSEN, pin 98						
V_{OL}	Low level Open Drain Output Voltage	$I_{OL} = 2 \text{ mA}$		0.1	0.3	V
LVC MOS/LVTTL DC SPECIFICATIONS (Pin 62 to pin 69 when operate in 3.3V LVTTL level)						
V_{OH}	High Level Input Voltage	$I_{OL} = 2 \text{ mA}$	2.2	2.95		V
V_{OL}	Low Level Input Voltage			0.055	0.4	V
I_{OS}	Output Short Circuit Current	$V_{OUT} = 0V$		-50	-120	mA

DC Characteristics (Continued)

Over recommended operating supply and temperature ranges unless otherwise specified.

Symbol	Parameter	Conditions	Min	Typ	Max	Units	
Low Voltage Level DC SPECIFICATIONS (pins D0 to D23, CLKINP, CLKINM, DE, HSYNC, VSYNC)							
V _{DDQ}	Low Swing Voltage	from GMCH	1		+1.8	V	
V _{ILSH}	Low Swing High Level Input Voltage		V _{REF+} 100mV		V _{DDQ}	V	
V _{ILSL}	Low Swing Low Level Input Voltage		0		V _{REF-} 100mV	V	
V _{REF}	Differential Input Reference Voltage		0.475	½V _{DDQ}	0.945	V	
LVDS DRIVER DC SPECIFICATIONS (Output pins AnP, AnM, CLKnP and CLKnM)							
V _{OD}	Differential Output Voltage	R _L = 100Ω	250	345	450	mV	
ΔV _{OD}	Change in V _{OD} between Complimentary Output States			3	35	mV	
V _{OS}	Offset Voltage		1.125	1.32	1.475	V	
ΔV _{OS}	Change in V _{OS} between Complimentary Output States			1.5	35	mV	
I _{OS}	Output Short Circuit Current	V _{OUT} = 0V	0	-8.5	-15	mA	
I _{OZ}	Output TRI-STATE Current	PD = 0V, V _{OUT} = 0V or V _{CC}		±0.1	±10	μA	
SUPPLY CURRENT							
I _{CC1}	Transmitter Supply Current when data input and clock input are at Low Swing level.	R _L = 100Ω, C _L = 5 pF, DUAL pin = GND, BAL = GND, one 12bit input, Pattern <i>Figure 1</i>	f = 65MHz, scaler off, 2.75V supply		70	120	mA
			f = 65 MHz, scaler off, 3.6V supply		38	90	mA
I _{CC2}	Transmitter Supply Current when data input and clock input are at Low Swing level.	R _L = 100Ω, C _L = 5 pF, DUAL pin = ½ V _{CC} , BAL = GND, one 12bit input, Pattern <i>Figure 1</i>	f = 108MHz, scaler off, 2.75V supply		85	130	mA
			f = 108 MHz, scaler off, 3.6V supply.		75	130	mA
I _{CC3}	Transmitter Supply Current when data input and clock input are at Low Swing level.	R _L = 100Ω, C _L = 5 pF, DUAL pin = GND, BAL = GND, one 12bit input	f = 65 MHz, scaler on, 2.75V supply		330	415	mA
I _{CC4}	Transmitter Supply Current when data input and clock input are at Low Swing level.	R _L = 100Ω, C _L = 5 pF, DUAL pin = ½V _{CC} , BAL = GND, one 12bit input	f = 108 MHz, scaler on, 2.75V supply		483	610	mA
ICCTZ	Transmitter Supply Current Power Down	PD = GND. TST1, TST2, TST3, ID0, ID1, ID2, ID3, A0, A1, A2, RES1, RES2, RES3, RES4 = GND, BAL = GND.			75		μA

Two-Wire Serial Communication Interface

Unless otherwise noted, below specifications apply for V_{CC3V} pin = 3.0V to 3.6V.

Symbol	Parameter	Conditions	Min	Typ	Max	Units
$V_{IN(1)}$	Logical " 1 " input voltage		2.1			V
$V_{IN(0)}$	Logical " 0 " input voltage				0.8	V
V_{OL}	Serial Bus Low level output voltage	$I_{OL} = 3mA$		0.1	0.4	V
		$I_{OL} = 6mA$		0.15	0.6	V

Recommended DVO Port Input Characteristics

Over recommended operating supply and temperature ranges unless otherwise specified.

Symbol	Parameter		Min	Typ	Max	Units
TCIT	TxCLK IN Transition Time (<i>Figure 4</i>)	DUAL = Gnd	0.8	1.2	2.4	ns
TCIP	TxCLK IN Period (<i>Figure 5</i>)	DUAL = Gnd	5.9	T	40	ns
TCIH	TxCLK in High Time (<i>Figure 5</i>)		0.35T	0.5T	0.65T	ns
TCIL	TxCLK in Low Time (<i>Figure 5</i>)		0.35T	0.5T	0.65T	ns
TXIT	D0 to D23 Transition Time			1		ns
VDDQ	Low Swing Voltage Amplitude from GMCH		1.0		1.8	V

AC Switching Characteristics

Over recommended operating supply and temperature ranges unless otherwise specified.

Symbol	Parameter		Min	Typ	Max	Units
LLHT	LVDS Low-to-High Transition Time (<i>Figure 3</i>). (Note 7)			0.14	0.8	ns
LHLT	LVDS High-to-Low Transition Time (<i>Figure 3</i>). (Note 7)			0.11	0.8	ns
TBIT	Transmitter Output Bit Width	DUAL pin = V_{CC} or Gnd		1/7 TCIP		ns
		DUAL pin = $\frac{1}{2}V_{CC}$		2/7 TCIP		ns
TCCS	TxOUT Channel to Channel Skew			100		ps
TPPOS0	Transmitter Output Pulse Position for Bit 0 (previous cycle) from CLK1P rising edge. (Note 7).	f = 65 MHz, DUAL pin = V_{CC}	-0.49	0	+0.49	ns
TPPOS1	Transmitter Output Pulse Position for Bit1 (previous cycle) from CLK1P rising edge. (Note 7)	f = 65 MHz, DUAL pin = V_{CC}	(1/7)TCIP -0.49	(1/7)TCIP	(1/7)TCIP +0.49	ns
TPPOS2	Transmitter Output Pulse Position for Bit2 from CLK1P rising edge. (Note 7)	f = 65 MHz, DUAL pin = V_{CC}	(2/7)TCIP -0.49	(2/7)TCIP	(2/7)TCIP +0.49	ns
TPPOS3	Transmitter Output Pulse Position for Bit3 from CLK1P rising edge. (Note 7)	f = 65 MHz, DUAL pin = V_{CC}	(3/7)TCIP -0.49	(3/7)TCIP	(3/7)TCIP +0.49	ns
TPPOS4	Transmitter Output Pulse Position for Bit4 from CLK1P rising edge. (Note 7)	f = 65 MHz, DUAL pin = V_{CC}	(4/7)TCIP -0.49	(4/7)TCIP	(4/7)TCIP +0.49	ns
TPPOS5	Transmitter Output Pulse Position for Bit5 from CLK1P rising edge. (Note 7)	f = 65 MHz, DUAL pin = V_{CC}	(5/7)TCIP -0.49	(5/7)TCIP	(5/7)TCIP +0.49	ns
TPPOS6	Transmitter Output Pulse Position for Bit6 from CLK1P rising edge. (Note 7)	f = 65 MHz, DUAL pin = V_{CC}	(6/7)TCIP -0.49	(6/7)TCIP	(6/7)TCIP +0.49	ns
TSTC	DxIN Setup to CLKINP (<i>Figure 6</i>) (Note 7)		0.8			ns
THTC	DxIN Hold to CLKINP (<i>Figure 6</i>) (Note 7)		0.8			ns
TJCC	Transmitter Jitter Cycle-to-cycle (Note 4)	f = 85 MHz, DUAL pin = Gnd		114		ps
		f = 54 MHz, DUAL pin = V_{CC}		114		ps
TPLLS	Transmitter Phase Lock Loop Set (<i>Figure 7</i>) (Note 7)				10	ms
TPDD	Transmitter Powerdown Delay (<i>Figure 8</i>) (Note 7)				100	ns
	Transmitter Input to Output Latency for single in-to-dual out mode. <i>Figure 9</i>	f = 170 MHz (Note 6)		1.5 TCIP +4.1		ns

Two-Wire Serial Communication Interface Switching Characteristics

Unless otherwise noted, below specifications apply for V_{CC3V} pin = +3.3V, load capacitance on output lines = 80 pF. Load capacitance on output lines can be up to 400pF provided that external pull-up is on board. The following parameters are the timing relationship between SCL and SDA signals related to the DS90C2501.

Symbol	Parameter	Min	Typ	Max	Units
t_1	SCL (Clock) Period	2.5		2000 (Note 7)	μ s
t_2	Data in Set-Up Time to SCL High	100			ns
t_3	Data Out Stable after SCL Low	0			ns
t_4	SDA Low Set-Up Time to SCL Low (Start Condition)	100			ns
t_5	SDA High Hold Time after SCL High (Stop Condition)	100			ns

Note 1: "Absolute Maximum Ratings" are those values beyond which the safety of the device cannot be guaranteed. They are not meant to imply that the device should be operated at these limits. The tables of "Electrical Characteristics" specify conditions for device operation.

Note 2: Typical values are given for $V_{CC} = 2.5V$ and $V_{CC3V} = 3.3V$ at $T_A = +25^\circ C$.

Note 3: Current into device pins is defined as positive. Current out of device pins is defined as negative. Voltages are referenced to ground unless otherwise specified (except V_{OD} and ΔV_{OD}).

Note 4: The limits are based on bench characterization of the device's jitter response over the power supply voltage range. Output clock jitter is measured with a cycle-to-cycle jitter of $\pm 20\%$ data input bit time applied to the input clock signal while data inputs are switching (see figures 11 and 12). This parameter is used when calculating system margin as described in AN-1059.

Note 5: Receiver Skew Margin is defined as the valid data sampling region at the receiver inputs. This margin takes into account transmitter output pulse positions (min and max) and the receiver input setup and hold time (internal data sampling window - RSPOS). This margin allows for LVDS interconnect skew, inter-symbol interference (both dependent on type/length of cable) and clock jitter.

$RSKM \geq$ cable skew (type, length) + source clock jitter (cycle to cycle).

Note 6: From $V = 1.25V$ of CLKINP to $V_{DIFF} = 0V$ of CLK1P when EDGE pin = Gnd, DUAL pin = Gnd or V_{CC} or $\frac{1}{2}V_{CC}$, BAL pin = Gnd.

Note 7: Guaranteed by Design

AC Timing Diagrams

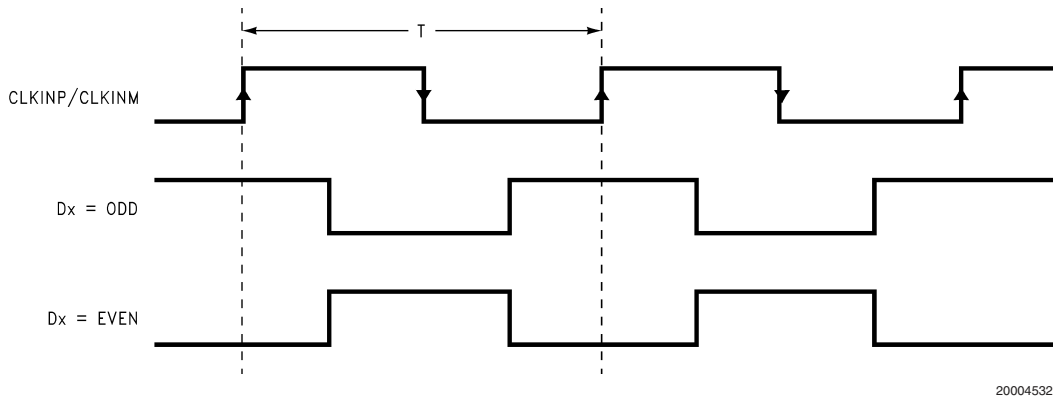
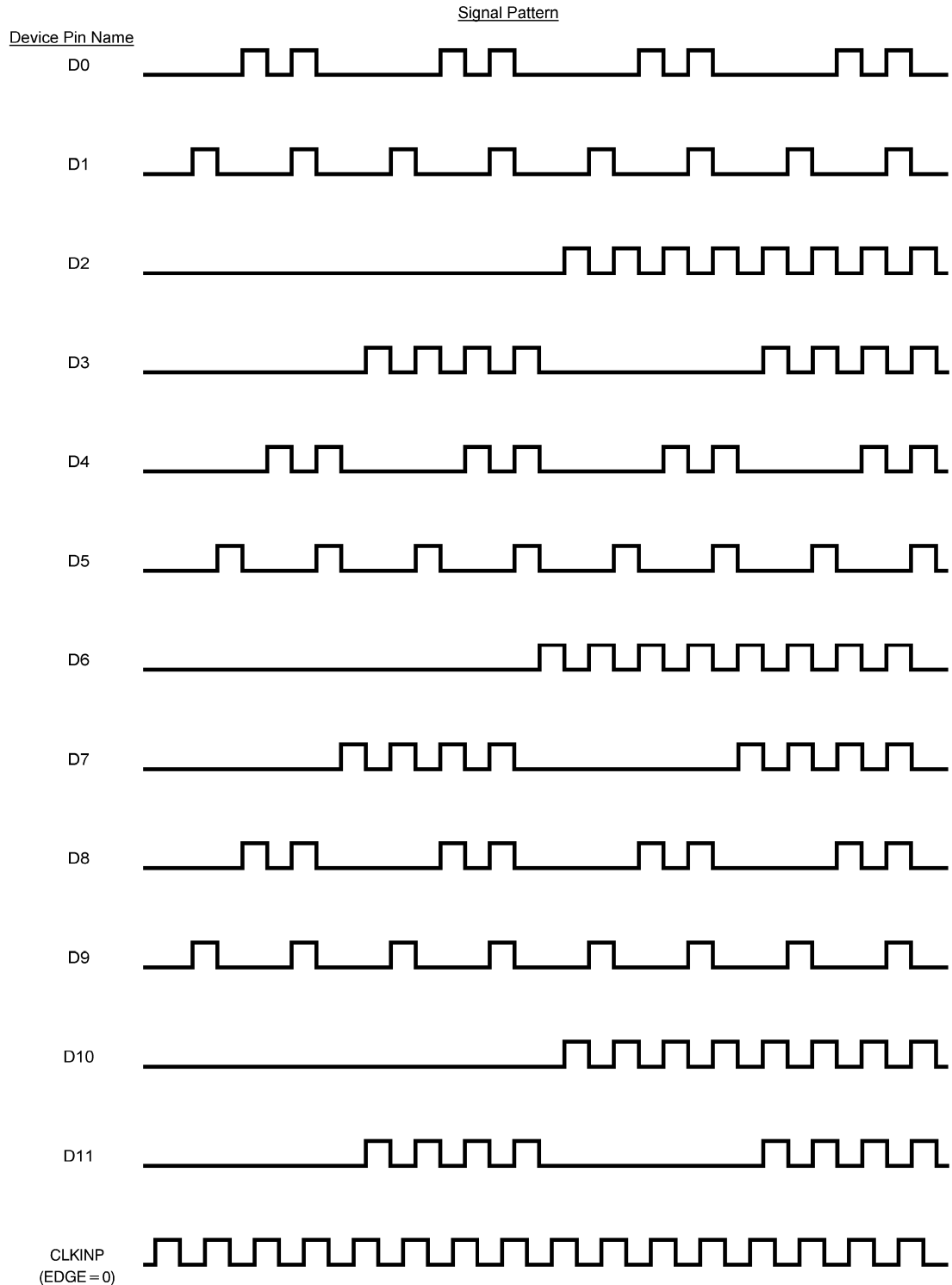

FIGURE 1. "Alternate High/Low" Test Pattern in 12-bit Input Mode (Note 8)

AC Timing Diagrams (Continued)



20004551

FIGURE 2. "16 Grayscale" Test Pattern in 12-bit Input Mode (Note 9)

Note 8: The "Alternate High/Low" test pattern produces a maximum toggling of digital circuits, LVDS I/O and CMOS/TTL I/O.

Note 9: The 16 grayscale test pattern tests device power consumption for a "typical" LCD display pattern. The test pattern approximates signal switching needed to produce groups of 16 vertical stripes across the display.

AC Timing Diagrams (Continued)

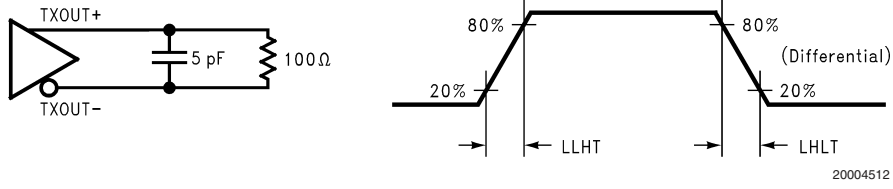

FIGURE 3. DS90C2501 (Transmitter) LVDS Output Load and Transition Times

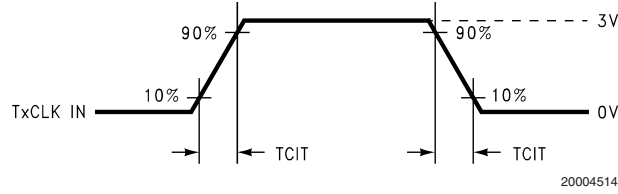

FIGURE 4. DS90C2501 (Transmitter) Input Clock Transition Time

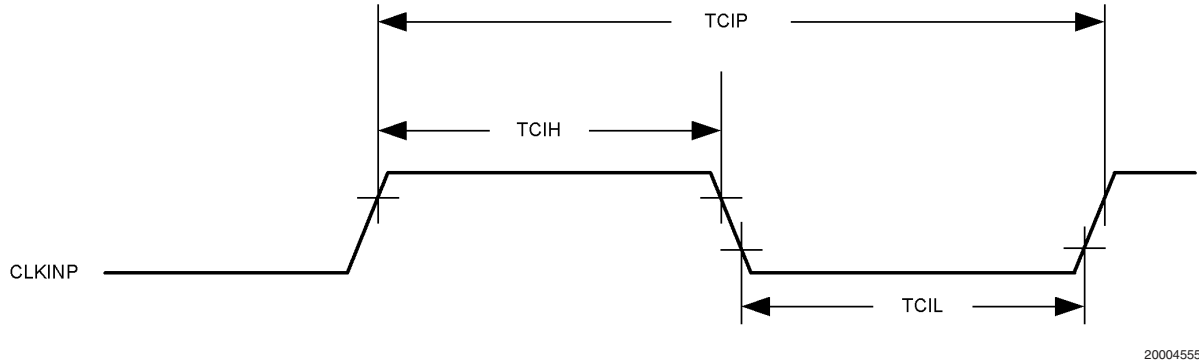

FIGURE 5. DS90C2501 (Transmitter) Input Clock High/Low Times

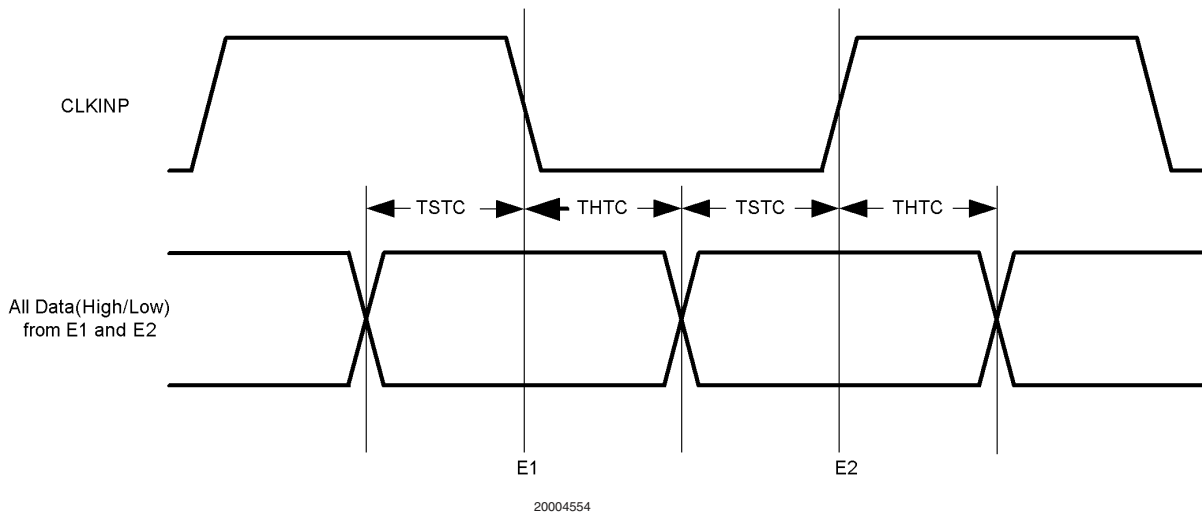

FIGURE 6. Setup/Hold Times, $V_{REF} = 0.900V$, $EDGE = Gnd$, $DUAL = V_{CC}$, $BAL = Gnd$

AC Timing Diagrams (Continued)

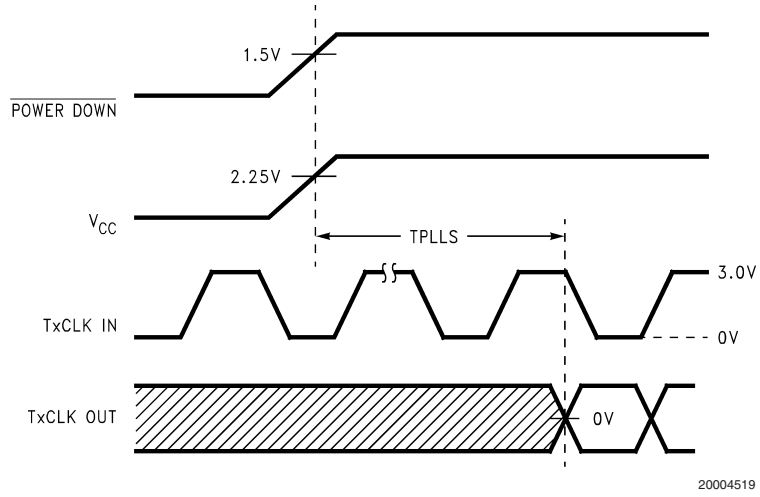

FIGURE 7. DS90C2501 (Transmitter) Phase Lock Loop Set Time

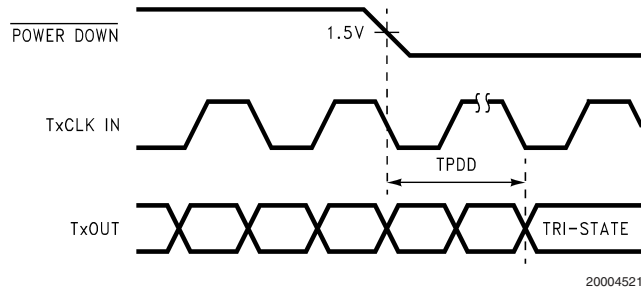

FIGURE 8. Transmitter Power Down Delay

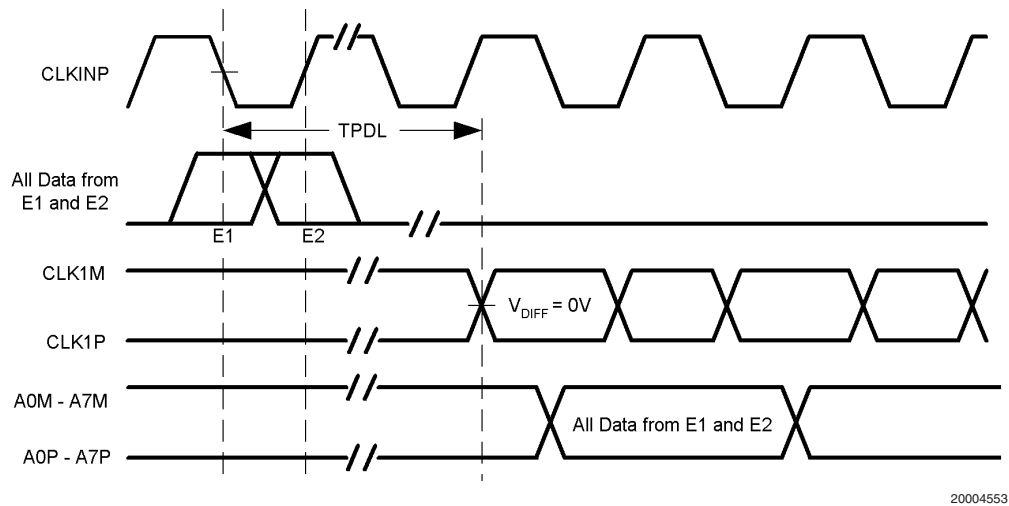
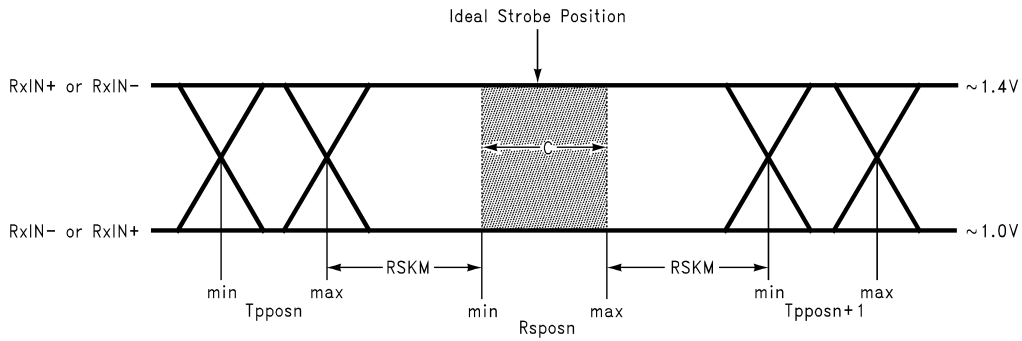

FIGURE 9. Transmitter Input to Output Latency

AC Timing Diagrams (Continued)



20004525

C—Setup and Hold Time (Internal data sampling window) defined by R_{spos} (receiver input strobe position) min and max

T_{ppos} —Transmitter output pulse position (min and max)

R_{SKM} = Cable Skew (type, length) + Source Clock Jitter (cycle to cycle) + ISI (Inter-symbol interference) (Note 10)

Cable Skew—typically 10 ps–40 ps per foot, media dependent

Note 10: ISI is dependent on interconnect length; may be zero

FIGURE 10. Receiver Skew Margin

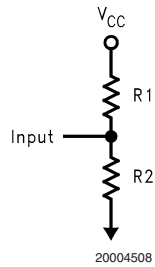

20004508

FIGURE 11. Resistor Network for “DUAL” pin input - recommend using $R1=R2=10k\Omega \pm 1\%$ for single to dual mode

DS90C2501 Pin Description

Pin Name	Pin No.	I/O Type	Description
DVO INTERFACE			
D0–D23	17, 16, 15, 14, 13, 12, 9, 8, 7, 6, 5, 4, 32, 31, 30, 29, 28, 27, 26, 25, 24, 23, 22, 21	I-LVTTL/ Low Swing (See V_{REF} signal description for more information on Low Swing)	DVO Port RGB input data When DUAL pin = GND inputs D0–D11 correspond to LVDS ports A0–A3. When DUAL pin = $\frac{1}{2}V_{CC}$, 1st pixel from D0–D11 corresponds to LVDS ports A0–A3, 2nd pixel from D0–D11 corresponds to LVDS ports A4–A7. When DUAL pin = V_{CC} , 1st pixel from D0–D11 corresponds to LVDS ports A0–A3, 2nd pixel from D12–D23 corresponds to LVDS ports A4–A7. Note: Ports refer to the corresponding differential LVDS pin pairs. The port A nomenclature should not be confused with the serial interface slave address pins AO-A2.
DE	3	I-LVTTL/ Low Swing	Display Data Enable. When High, input pixel data is valid to DS90C2501 when R_FDE bit = High (default). See RFDE register field for more information .
HSYNC	2	I-LVTTL/ Low Swing	Display Horizontal Sync input control signal.
VSYN	1	I-LVTTL/ Low Swing	Display Vertical Sync input control signal.
CLKINP	10	I-LVTTL/ Low Swing Differential	“Positive” differential pixel clock input. A differential clock is recommended for applications 65 MHz or higher.
CLKINM	11	I-LVTTL/ Low Swing Differential	“Minus” differential pixel clock input. A differential clock is recommended for applications 65 MHz or higher.
HOST INTERFACE			
$\overline{\text{RESETN}}$	61	I-LVTTL 2.5	Active low RESET signal. Asserting $\overline{\text{RESETN}}$ will reset all internal logic and clear the Host Interface registers.
S2CCLK	72	I-LVTTL3V	This is the clock line for the two-wire serial communication interface. Normally a pull-up resistor is required in the system.
S2CDAT	71	I/O-LVTTL3V	This is the data line for two-wire serial communication interface. A Pull-up resistor is normally required in the system.
MSEN	98	O-LVTTL 2.5	Interrupt signal. This is an open drain output, a pull-up resistor is required. Please refer to MDI, RSEN, TSEL and MSEL register fields in Register Field Definitions for more information. This signal requires support from host software.
$\overline{\text{PD}}$	99	I-LVTTL 2.5	Power Down Signal. A logic “0” will place the device in power down mode per <i>Table 1</i> below. When maximum power savings is desired, the PD pin or soft power down bit (Reg 08h bit 0) should be used to power down the DS90C2501. LVDS outputs of the device will be in TRI-STATE. Scaling engine will be powered down, and retain all register values. PLL will be powered down. All data input pads will be powered down. V_{REF} circuit is powered down. The two-wire serial communication interface remains active and all register contents will be retained. All GPIO pins will be disabled (tri-state if programmed as an output). ENAVDD, ENABKL, PWM, VSTALL and HIRQ pins remain active and can be accessed through the two-wire serial communication interface.
CLOCK			
REFCLK1	18	I-LVTTL3V	Reference clock,— A 3V, 14.318 MHz clock is required for internal control and timing. This clock must be stable when the DS90C2501 is powered-up.

DS90C2501 Pin Description (Continued)

Pin Name	Pin No.	I/O Type	Description
OPTION SELECTION			
BAL	97	I-LVTTL 2.5	Tie this pin to GND.
DUAL	35	I-LVTTL 2.5	<p>LVTTTL level input.</p> <p>Input = GND for single pixel in-to-single pixel out mode. LVDS output channels A0 to A3 are enabled, A4 to A7 are CLK2 are disable.</p> <p>Input = V_{CC} for dual pixel in-to-dual pixel out mode. LVDS output channel A0 to A7, CLK1 and CLK2 are enable. Use a 10K typ. pull-up resistor.</p> <p>Input = $\frac{1}{2}V_{CC}$ for single pixel in-to-dual pixel out mode. LVDS output channel A0 to A7, CLK1 and CLK2 are enabled. See register CFG1 (08h) BPASS field for more information.</p> <p>See <i>Figure 11</i> for example interface circuit.</p>
COLOR	34	I-LVTTL 2.5	<p>LVTTTL level input to select RGB to LVDS color mapping.</p> <p>Tie to GND for 18-bit/36-bit LCD.</p> <p>Tie to GND to select conventional color mapping for 24-bit/48-bit LCD.</p> <p>Tie to Logic "1" to select non-conventional color mapping for 24-bit/48-bit LCD.</p>
A0, A1, A2	115, 116, 117	I-LVTTL 2.5	These are input pins to select the 2-wire Serial Communication Slave Device Address Lower Bits.
EDGE	36	I-LVTTL 2.5	<p>Selects primary clock edge E1.</p> <p>Tie to Logic "1" to select Rising edge for E1.</p> <p>Tie to ground to select Falling edge for E1.</p>
PANEL INTERFACE			
A0P, A1P, A2P, A3P	55, 53, 51, 47	O-LVDS	<p>Positive LVDS differential data output.</p> <p>When DUAL pin = GND, input to D0–D11 will be coming out of A0P to A3P. For 6-bit color application, no connect for channel A3P.</p> <p>When DUAL pin = $\frac{1}{2}V_{CC}$, the first pixel going in D0–D11 will be coming out of A0P to A3P, and the second pixel going in D0–D11 will come out of A4P to A7P. For 6-bit color application, no connect for channels A3P and A7P.</p> <p>When DUAL pin = V_{CC}, the first pixel going in D0–D11 will be coming out of A0P to A3P, the second pixel going in D12–D23 will be coming out of A4P to A7P. For 6-bit color application, no connect for channels A3P and A7P.</p>
A0M, A1M, A2M, A3M	56, 54, 52, 48	O-LVDS	<p>Negative LVDS differential data output.</p> <p>When DUAL pin = GND, input to D0–D11 will be coming out of A0M to A3M. For 6-bit color application, no connect for channel A3M.</p> <p>When DUAL pin = $\frac{1}{2}V_{CC}$, the first pixel going in D0–D11 will be coming out of A0M to A3M, and the second pixel going in D0–D11 will come out of A4M to A7M. For 6-bit color application, no connect for channels A3M and A7M.</p> <p>When DUAL pin = V_{CC}, the first pixel going in D0–D11 will be coming out of A0M to A3M, the second pixel going in D12–D23 will be coming out of A4M to A7M. For 6-bit color application, no connect for channels A3M and A7M.</p>
A4P, A5P, A6P, A7P	45, 43, 41, 39	O-LVDS	<p>Positive LVDS differential data output for second pixel.</p> <p>When DUAL pin = GND, input to D0–D11 will be coming out of A0P to A3P. For 6-bit color application, no connect for channel A3P.</p> <p>When DUAL pin = $\frac{1}{2}V_{CC}$, the first pixel going in D0–D11 will be coming out of A0P to A3P, and the second pixel going in D0–D11 will come out of A4P to A7P. For 6-bit color application, no connect for channels A3P and A7P.</p> <p>When DUAL pin = V_{CC}, the first pixel going in D0–D11 will be coming out of A0P to A3P, the second pixel going in D12–D23 will be coming out of A4P to A7P. For 6-bit color application, no connect for channels A3P and A7P.</p>

DS90C2501 Pin Description (Continued)

Pin Name	Pin No.	I/O Type	Description
OPTION SELECTION			
A4M, A5M, A6M, A7M	46, 44, 42, 40	O-LVDS	Negative LVDS differential data output for second pixel. When DUAL pin = GND, input to D0–D11 will be coming out of A0M to A3M. For 6-bit color application, no connect for channel A3M. When DUAL pin = $\frac{1}{2}V_{CC}$, the first pixel going in D0–D11 will be coming out of A0M to A3M, and the second pixel going in D0–D11 will come out of A4M to A7M. For 6-bit color application, no connect for channels A3M and A7M. When DUAL pin = V_{CC} , the first pixel going in D0–D11 will be coming out of A0M to A3M, the second pixel going in D12–D23 will be coming out of A4M to A7M. For 6-bit color application, no connect for channels A3M and A7M.
CLK1P	49	O-LVDS	Positive LVDS differential clock output.
CLK1M	50	O-LVDS	Negative LVDS differential clock output.
CLK2P	37	O-LVDS	Additional positive LVDS differential clock output pin. Identical to CLK1P. No connect if not used.
CLK2M	38	O-LVDS	Additional negative LVDS differential clock output pin. Identical to CLK1M. No connect if not used.
ID0, ID1, ID2, ID3	57, 58, 59, 60	I-LVTTL 2.5	These four pins are used to select one out of 16 pre-determined LCD display timing information. The values are from 0 to 15. This function requires support from VBIOS or display driver. Tie these pins to GND when not in use. Tie these four pins [ID3, ID2, ID1, ID0] to High or Low for selecting LCD panel. ID0 is the LSB, and ID3 is the MSB. For example: 1000 will select the 9th LCD panel. A 4-bit register field [3:0] will be used to store the selected value for the host to read. See PANEL field for more information.
ENAVDD	69	O-LVTTL 2.5	Output to control LCD panel power under software control. Typically, this output is used with a power switch such as a FET circuit to control LCD panel V_{CC} (Note 11).
ENABKL	68	O-LVTTL 2.5	Output to control LCD panel back light power under software control. Typically, this output is used to control the enable on a backlight inverter (Note 11).
MISCELLANEOUS/TEST			
GPIO1, GPIO2, GPIO3	64, 63, 62	I/O-LVTTL 3V	General purpose inputs or outputs referenced to GND. When the device is powered up, this pin defaults to an input. When the scaler is in the power down state these signals are tri-state if programmed as outputs (Note 11).
CLK_INV	114	I-LVTTL 2.5	This pin is used to invert the polarity of the incoming pixel CLK (CLKINP/CLKINM). A logic 0 = Normal, Logic 1 = Invert.
RES2	70	I-LVTTL 2.5	This pin is used in production testing and should be tied to GND in normal operation.
RES3	113	I-LVTTL 2.5	This pin is used in production testing and should be tied to GND in normal operation.
RES4	100	I-LVTTL 2.5	This pin is used in production testing and should be tied to GND in normal operation.
PWM	67	O-LVTTL 3V	This signal was provided for legacy support and is no longer required. This pin should be left open in normal operation.
VSTALL	66	O-LVTTL 3V	This signal was provided for legacy support and is no longer required. This pin should be left open in normal operation.
HIRQ	65	O-LVTTL 3V	This signal was provided for legacy support and is no longer required. This pin should be left open in normal operation.

DS90C2501 Pin Description (Continued)

Pin Name	Pin No.	I/O Type	Description
OPTION SELECTION			
V_{REF}	83	I-ANALOG	<p>This pin is never to be left floating and never tie to GND.</p> <p>For LVTTTL level data input, tie V_{REF} to V_{CC3V}. When $V_{REF} > 1.8V$, input data is set to LVTTTL level.</p> <p>For low voltage swing level data input, tie V_{REF} to $\frac{1}{2}V_{DDQ}$ (V_{DDQ} provided by host interface) V_{DDQ} is from the host. When $V_{REF} \leq 1.0V$, indicates input data is in low voltage swing mode.</p> <p>Input data = logic High = $V_{REF} + 100\text{ mV}$ in low voltage swing level.</p> <p>Input data = logic Low = $V_{REF} - 100\text{ mV}$ in low voltage swing level.</p>
TST1, TST2, TST3	19, 20, 85	I-LVTTTL 2.5	These pins are used in production testing and should be tied to GND in normal operation.
POWER (See Application Information for power supply decoupling requirements)			
V_{CC}/DV_{CC}	81, 82, 75, 77, 96, 119, 123, 125	PWR	Power supply pins (pin 75, 77, 81, 82, 96, 119, 123, and 125) for 2.5V LVTTTL inputs and digital circuitry.
GND/DGND	33, 73, 74, 76, 78, 79, 80, 84, 118, 122, 124	PWR	GND or DGND reference for 2.5V TTL inputs and digital circuitry.
V_{CC3V}	121, 127	PWR	The V_{CC3V} is required for internal logic and certain 3V I/O. During power up stage, voltage readings on these pins must be higher than 2.5V pins.
GND3V	120, 126, 128	PWR	Ground return pins for V_{CC3V} powered logic.
SPLL V_{CC}	87, 89	PWR	2.5V power supply pins for scaler PLL circuitry. It is not recommended to share this power with PLL V_{CC} .
SPLLGND	86, 88, 90	PWR	Ground returns for scaler PLL circuitry.
PLL V_{CC}	92, 94	PWR	2.5V power supply pins for Tx PLL circuitry. It is not recommended to share this power with SPLL V_{CC} .
PLLGND	91, 93, 95	PWR	Ground returns for Tx PLL circuitry.
LVDS V_{CC}	105, 109	PWR	Power supply pins for LVDS output drivers.
LVDSGND	104, 108	PWR	Ground return pins for LVDS output drivers.
LVDS V_{CC3V}	101, 103, 107, 111	PWR	3V power supply pins for LVDS output drivers. During power up stage, voltage readings on these pins must be higher than 2.5V pins.
LVDSGND3V	102, 106, 110, 112	PWR	Ground return pins for 3V LVDS outputs.

Note 11: When device power is applied, it is possible for these outputs to switch to a logic "1" momentarily as the 3.3V is rising and before 2.5V reaches at least 0.8V. During this brief period, the pad control logic could be non-deterministic, RESETN will have no effect. It is recommended these outputs are gated externally if the system design requires them to remain in the inactive logic "0" state during power-on.

DS90C2501 Pin Description (Continued)

TABLE 1. scaler is powered down under these conditions

	scaler is On	scaler is OFF
/PD pin	H	L
DUAL pin provided that PD bit is 1 and BYPASS bit is 0	L or $\frac{1}{2}V_{CC}$	L or $\frac{1}{2}V_{CC}$ or VCC
No input clock is detected	NO	YES
PD bit issued by host	1	0
BYPASS bit issued by host.	0	1

Two-Wire Serial Communication Interface Description

There are two register sets on DS90C2501. One set is for controlling the input and output blocks as shown below, and one set is for controlling the scaler which is not shown on this datasheet. Both register sets are accessible by the host system through the Two-Wire Serial Communication Interface. The DS90C2501 operates as a slave on the Serial Bus, so the SCL line is an input (no clock is generated by the DS90C2501) and the SDA line is bi-directional. DS90C2501 has a 7-bit slave address. The address bits are controlled by the state of the address select pins A2, A1 and A0, and are set by connecting these pins to ground for a LOW, (0) , to $V_{CC}3V$ pin for a HIGH, (1).

Therefore, the complete slave address is:

A6	A5	A4	A3	A2	A1	A0
MSB			LSB			

and is selected as follows:

Address Select Pin State			DS90C2501 Serial Bus Slave Address (A6:A3 are hardwired to "0111")
A2	A1	A0	A6:A0 binary
0	0	0	0111000
0	0	1	0111001
0	1	0	0111010
0	1	1	0111011
1	0	0	0111100
1	0	1	0111101
1	1	0	0111110
1	1	1	0111111

The DS90C2501 latches the state of the address select pins during the first read or write on the Serial Bus. Changing the state of the address select pins after the first read or write to any device on the Serial Bus will not change the slave address of the DS90C2501.

Communicating with the DS90C2501 Control Registers

All registers are predefined as read only, or read and write. The Serial Interface will always attempt to detect if a LCD panel/monitor is connected.

A **Write** to the DS90C2501 will always include the slave address byte, data register address byte, a data byte.

A **Read** from the DS90C2501 can take place either of two ways:

1. If the location latched in the data register addresses is correct , then the read can simply consist of a slave address byte, followed by retrieving the data byte.
2. If the data register address needs to be set, then a slave address byte, data register address will be sent first, then the master will repeat start, send the slave address byte and receive data byte to accomplish a read.

The data byte has the most significant bit first. At the end of a read, the DS90C2501 can accept either Acknowledge or No Acknowledge from the Master (No Acknowledge is typically used as a signal for the slave that the Master has read its last byte).

Serial Bus Protocol

The DS90C2501 slave state machine does not require an internal clock, and supports only byte read and write. Page mode is not supported. The 7-bit binary address is "0111A₂A₁A₀", where A₂A₁A₀ are pin programmable and A6:A3 are hardwired internally to "0111"

Serial Bus Protocol (Continued)

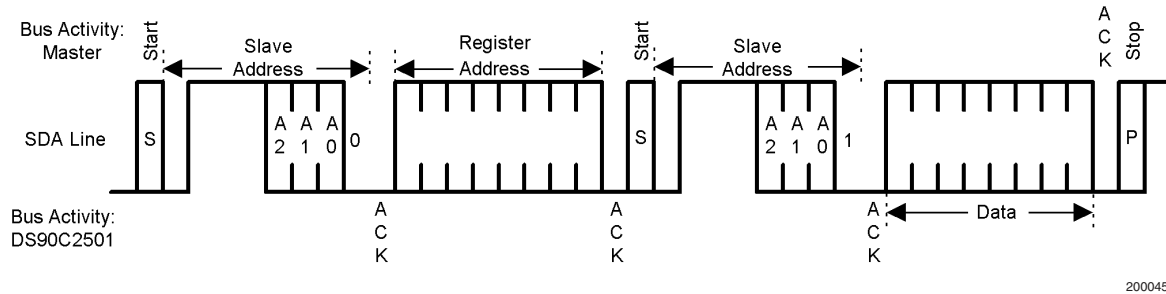

FIGURE 12. Byte Read

The master must generate a “ Start ”, and send the 7-bit slave address plus a 0 first, and wait for acknowledge from DS90C2501. When DS90C2501 acknowledges (the 1st ACK) that the master is calling, the master then sends the data register address byte, and waits for acknowledge from the slave. When the slave acknowledges (the 2nd ACK), the master repeats the “ Start ” by sending the 7-bit slave address plus a 1 (indicating that READ operation is in progress), and waits for acknowledge from DS90C2501. After the slave responds (the 3rd ACK), the slave sends the

data to the bus, and waits for acknowledge from the master. When the master acknowledges (the 4th ACK), and generates a “ Stop ”, this completes the “ READ ”.

If the 4th ACK is received from the master and no “ Stop ” follows it, the slave will keep sending the data of next register until “ Stop ” is received from the master. If the 4th ACK is not received from the master, the slave will terminate the Serial Bus communication, and giving the bus control back to the master.

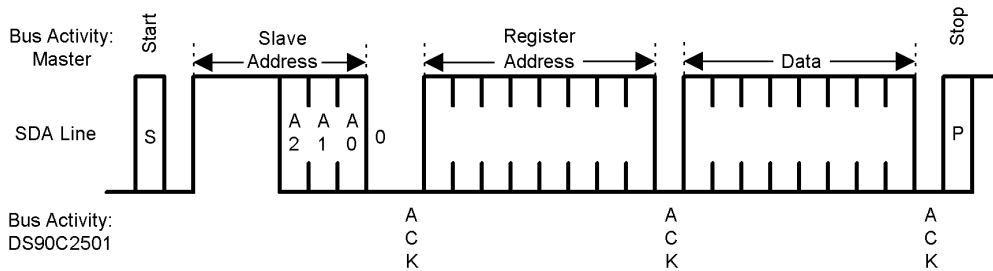

FIGURE 13. Byte Write

The master must generate a “ Start ”, and send the 7-bit slave address plus a 0 and wait for acknowledge from DS90C2501. When DS90C2501 acknowledges (the 1st ACK), that the master is calling, the master then sends the data register address byte, and waits for acknowledge from the slave. When the slave acknowledges (the 2nd ACK), the master sends the data byte and wait for acknowledge from the slave. When the slave acknowledges (the 3rd ACK), the master generates a “ Stop ”. This completes the “ WRITE ”.

If the master doesn’t generate the “ Stop ”, the master can keep sending data to location of the next register address (Register Address + 1), and waits for acknowledge from the

slave. If the slave acknowledges, the master can send data to the next register address (Register Address + 2). If the slave doesn’t acknowledge, the master will have the control of the bus and can generate a “ Stop ” to end the “ WRITE ” operation. During the process, if the master attempts to send data to “ Read Only ” registers, the slave will not acknowledge and return the bus control back to the master. A complete programming guide is available for the DS90C2501 to OEM customers. This can be obtained by contacting your local National Semiconductor sales representative.

Host Control Register Descriptions

Register Name: VND_IDL
 Address Offset: 00h
 Default Value: 05h
 Access Method: Read Only

Host Control Register Descriptions (Continued)

Bit	Description
7:0	Vendor ID Low Byte

Register Name: VND_IDH

Address Offset: 01h

Default Value: 13h

Access Method: Read Only

Bit	Description
7:0	Vendor ID High Byte

Register Name: DEV_IDL

Address Offset: 02h

Default Value: 26h

Access Method: Read Only

Bit	Description
7:0	Device ID Low Byte

Register Name: DEV_IDH

Address Offset: 03h

Default Value: 67h

Access Method: R/W

Bit	Description
7:0	Device ID High Byte

Register Name: DEVICE REVISION

Address Offset: 04h

Default Value: 01h

Access Method: R/W

Bit	Description
7:0	Device Revision Value

Register Name: RESERVED

Address Offset: 05h

Default Value: A5h

Access Method: Read Only

Bit	Description
7:0	Reserved

Register Name: FRQ_LOW

Address Offset: 06h

Default Value: 19h

Access Method: Read Only

Bit	Description
7:0	Minimum LVDS Output Frequency (25 MHz)

Register Name: FRQ_HIGH

Address Offset: 07h

Default Value: See Description

Access Method: Read Only

Bit	Description
7:0	Maximum LVDS Output Frequency
	If DUAL = GND or V_{CC} value is A2h (162 MHz)
	If DUAL = $\frac{1}{2}V_{CC}$ value is 55h (85 MHz)

Host Control Register Descriptions (Continued)

Register Name: CFG1

Address Offset: 08h

Default Value: 39h

Access Method: R/W

Bit	Description
0	Soft Power Down; 0 = Power Down, 1 = Normal Operation
1	Reserved
2	BPASS (1 = bypass, 0 = non-bypass) This field is valid only when DUAL pin is 0V or $\frac{1}{2}V_{CC}$. Note: When image scaling is not required power savings can be achieved in bypass mode.
3	DSEL 0= Input clock is differential (recommended for clocks above 65 MHz), 1= input clock is single-ended
4	HEN (HSYNC enable) 0= HSYNC is transmitted as a fixed low, 1= HSYNC is same as input
5	VEN (VSYNC enable) 0= VSYNC is transmitted as a fixed low, 1= VSYNC is same as input
7:6	Reserved

Host Control Register Descriptions (Continued)

Register Name: CFG2

Address Offset: 09h

Default Value: 95h

Access Method: R/W

Bit	Description
0	MDI (read only)
1	Reserved
2	RSEN (read only)— Receiver Sense 0= LVDS receiver connected to transmitter output, 1= No receiver connected Note: this function is valid only with DC coupled systems
3	TSEL — Interrupt generation 0= Interrupt bit (MDI) is generated by monitoring RSEN, fixed valve
4:6	MSEL (R/W)— Selects source for MSEL output pin 000= MSEN disabled 001= Output the MDI bit - interrupt 010= Output the RSEN bit - receiver detect 011–111= Reserved
7	VLOW (read only) 1= V_{REF} set for low swing, 0= V_{REF} set for LVTTL

Register Name: CFG3

Address Offset: 0Ah

Default Value: 81H

Access Method: R/W

Bit	Description
0	R_FDE- Input DE strobe Polarity Select 0 = DE active Low, 1 = DE active High
3:1	Reserved
7:4	Reserved

Register Name: CFG

Address Offset: 0Bh

Default Value: See Description

Access Method: Read Only

Bit	Description
7:0	Contains state of input data bits 23:16

Register Name: PANEL

Address Offset: 0Ch

Default Value: See Description

Access Method: R/W

Bit	Description
0:3	System defined Panel ID values set on ID0:3 pins (Read Only)
4:7	System defined Panel ID field which can be written/ read from host

Host Control Register Descriptions (Continued)

Register Name: DEBUG_A

Address Offset: 0Dh

Default Value: See Description—Depends on pin state

Access Method: Mixed

Bit	Description
1:0	DUAL (1:0), State of DUAL pin (Read Only) 00= SISO 01= SIDO 11= DIDO
2	PLLOCK (Read Only)
3	Reserved (Read Only)
7:4	Reserved (R/W)

Register Name: RESERVED

Address Offset: 0Eh–0Fh

Default Value: 00h

Access Method: R/W

Bit	Description
7:0	Reserved

LVDS Interface

TABLE 2. LVDS data bit naming convention

X	Y	Z	Description
X=R			Red
X=G			Green
X=B			Blue
	Y=1		Odd (First) Pixel
	Y=2		Even (Second) Pixel
		Z=0-7	LVDS bit number (not VGA controller LSB to MSB)

LVDS Interface (Continued)**TABLE 3. Conventional Data mapping for one 12-bit (two data per clock)single pixel in-to-single pixel out application (DUAL = Gnd, only Port1 A0-A3 are active, BAL = Gnd)**

VGA - TFT Data Signals Color Bits			Transmitter input pin names	Receiver output pin names	TFT Panel Data Signals	
	24-bit	18-bit	DS90C2501	DS90CF388	18-bit	24-bit
LSB	R0		E2-D4	R16		R0
	R1		E2-D5	R17		R1
	R2	R0	E2-D6	R10	R0	R2
	R3	R1	E2-D7	R11	R1	R3
	R4	R2	E2-D8	R12	R2	R4
	R5	R3	E2-D9	R13	R3	R5
	R6	R4	E2-D10	R14	R4	R6
MSB	R7	R5	E2-D11	R15	R5	R7
LSB	G0		E1-D8	G16		G0
	G1		E1-D9	G17		G1
	G2	G0	E1-D10	G10	G0	G2
	G3	G1	E1-D11	G11	G1	G3
	G4	G2	E2-D0	G12	G2	G4
	G5	G3	E2-D1	G13	G3	G5
	G6	G4	E2-D2	G14	G4	G6
MSB	G7	G5	E2-D3	G15	G5	G7
LSB	B0		E1-D0	B16		B0
	B1		E1-D1	B17		B1
	B2	B0	E1-D2	B10	B0	B2
	B3	B1	E1-D3	B11	B1	B3
	B4	B2	E1-D4	B12	B2	B4
	B5	B3	E1-D5	B13	B3	B5
	B6	B4	E1-D6	B14	B4	B6
MSB	B7	B5	E1-D7	B15	B5	B7

LVDS Interface (Continued)

**TABLE 4. Conventional Data mapping for one 12-bit (two data per clock)single pixel in-to-dual pixel out application
(DUAL = $1/2V_{CC}$, Port1 A0-A3 and Port2 A4-A7 are active, BAL = Gnd)**

VGA - TFT Data Signals Color Bits		Transmitter input pin names	Receiver output pin names	TFT Panel Data Signals	
	24-bit	DS90C2501	DS90CF388	18-bit	24-bit
Port 1-Primary (the first active RGB pixel)					
LSB	R0	E2-D4	R16		RO0
	R1	E2-D5	R17		RO1
	R2	E2-D6	R10	RO0	RO2
	R3	E2-D7	R11	RO1	RO3
	R4	E2-D8	R12	RO2	RO4
	R5	E2-D9	R13	RO3	RO5
	R6	E2-D10	R14	RO4	RO6
MSB	R7	E2-D11	R15	RO5	RO7
LSB	G0	E1-D8	G16		GO0
	G1	E1-D9	G17		GO1
	G2	E1-D10	G10	GO0	GO2
	G3	E1-D11	G11	GO1	GO3
	G4	E2-D0	G12	GO2	GO4
	G5	E2-D1	G13	GO3	GO5
	G6	E2-D2	G14	GO4	GO6
MSB	G7	E2-D3	G15	GO5	GO7
LSB	B0	E1-D0	B16		BO0
	B1	E1-D1	B17		BO1
	B2	E1-D2	B10	BO0	BO2
	B3	E1-D3	B11	BO1	BO3
	B4	E1-D4	B12	BO2	BO4
	B5	E1-D5	B13	BO3	BO5
	B6	E1-D6	B14	BO4	BO6
MSB	B7	E1-D7	B15	BO5	BO7
Port 2-Secondary (the second active RGB pixel)					
LSB	R0	E4-D4	R26		RE0
	R1	E4-D5	R27		RE1
	R2	E4-D6	R20	RE0	RE2
	R3	E4-D7	R21	RE1	RE3
	R4	E4-D8	R22	RE2	RE4
	R5	E4-D9	R23	RE3	RE5
	R6	E4-D10	R24	RE4	RE6
MSB	R7	E4-D11	R25	RE5	RE7
LSB	G0	E3-D8	G26		GE0
	G1	E3-D9	G27		GE1
	G2	E3-D10	G20	GE0	GE2
	G3	E3-D11	G21	GE1	GE3
	G4	E4-D0	G22	GE2	GE4
	G5	E4-D1	G23	GE3	GE5
	G6	E4-D2	G24	GE4	GE6
MSB	G7	E4-D3	G25	GE5	GE7
LSB	B0	E3-D0	B26		BE0
	B1	E3-D1	B27		BE1
	B2	E3-D2	B20	BE0	BE2

LVDS Interface (Continued)

**TABLE 4. Conventional Data mapping for one 12-bit (two data per clock)single pixel in-to-dual pixel out application
(DUAL = $1/2V_{CC}$, Port1 A0-A3 and Port2 A4-A7 are active, BAL = Gnd) (Continued)**

VGA - TFT Data Signals Color Bits		Transmitter input pin names	Receiver output pin names	TFT Panel Data Signals	
	B3	E3-D3	B21	BE1	BE3
	B4	E3-D4	B22	BE2	BE4
	B5	E3-D5	B23	BE3	BE5
	B6	E3-D6	B24	BE4	BE6
MSB	B7	E3-D7	B25	BE5	BE7

LVDS Interface (Continued)

TABLE 5. Conventional Data Mapping for two 12-bit (two data per clock)dual pixel in-to-dual pixel out application(DUAL = V_{CC}, Port1 A0-A3 and Port2 A4-A7 are active, BAL = Gnd.)

VGA - TFT Data Signals Color Bits		Transmitter input pin names	Receiver output pin names	TFT Panel Data Signals	
	24-bit	DS90C2501	DS90CF388	18-bit	24-bit
Port 1-Primary (the first active RGB pixel)					
LSB	R0	E2-D4	R16		R0
	R1	E2-D5	R17		R1
	R2	E2-D6	R10	R0	R2
	R3	E2-D7	R11	R1	R3
	R4	E2-D8	R12	R2	R4
	R5	E2-D9	R13	R3	R5
	R6	E2-D10	R14	R4	R6
MSB	R7	E2-D11	R15	R5	R7
LSB	G0	E1-D8	G16		G0
	G1	E1-D9	G17		G1
	G2	E1-D10	G10	G0	G2
	G3	E1-D11	G11	G1	G3
	G4	E2-D0	G12	G2	G4
	G5	E2-D1	G13	G3	G5
	G6	E2-D2	G14	G4	G6
MSB	G7	E2-D3	G15	G5	G7
LSB	B0	E1-D0	B16		B0
	B1	E1-D1	B17		B1
	B2	E1-D2	B10	B0	B2
	B3	E1-D3	B11	B1	B3
	B4	E1-D4	B12	B2	B4
	B5	E1-D5	B13	B3	B5
	B6	E1-D6	B14	B4	B6
MSB	B7	E1-D7	B15	B5	B7
Port 2-Secondary (the second active RGB pixel)					
LSB	R0	E2-D16	R26		R0
	R1	E2-D17	R27		R1
	R2	E2-D18	R20	R0	R2
	R3	E2-D19	R21	R1	R3
	R4	E2-D20	R22	R2	R4
	R5	E2-D21	R23	R3	R5
	R6	E2-D22	R24	R4	R6
MSB	R7	E2-D23	R25	R5	R7
LSB	G0	E1-D20	G26		G0
	G1	E1-D21	G27		G1
	G2	E1-D22	G20	G0	G2
	G3	E1-D23	G21	G1	G3
	G4	E2-D12	G22	G2	G4
	G5	E2-D13	G23	G3	G5
	G6	E2-D14	G24	G4	G6
MSB	G7	E2-D15	G25	G5	G7
LSB	B0	E1-D12	B26		B0
	B1	E1-D13	B27		B1
	B2	E1-D14	B20	B0	B2

LVDS Interface (Continued)

TABLE 5. Conventional Data Mapping for two 12-bit (two data per clock)dual pixel in-to-dual pixel out application(DUAL = V_{CC} , Port1 A0-A3 and Port2 A4-A7 are active, BAL = Gnd.) (Continued)

VGA - TFT Data Signals Color Bits		Transmitter input pin names	Receiver output pin names	TFT Panel Data Signals	
	B3	E1-D15	B21	B1	B3
	B4	E1-D16	B22	B2	B4
	B5	E1-D17	B23	B3	B5
	B6	E1-D18	B24	B4	B6
MSB	B7	E1-D19	B25	B5	B7

LVDS Interface (Continued)

TABLE 6. Non-Conventional Data mapping for one 12-bit (two data per clock)single pixel in-to-single pixel out application (DUAL = Gnd, only Port1 A0-A3 are active, BAL= Gnd)

VGA - TFT Data Signals Color Bits			Transmitter input pin names	Receiver output pin names	TFT Panel Data Signals	
	24-bit	18-bit	DS90C2501	DS90CF388	18-bit	24-bit
LSB	R0		E2-D4	R16		R0
	R1		E2-D5	R17		R1
	R2	R0	E2-D6	R10	R0	R2
	R3	R1	E2-D7	R11	R1	R3
	R4	R2	E2-D8	R12	R2	R4
	R5	R3	E2-D9	R13	R3	R5
	R6	R4	E2-D10	R14	R4	R6
MSB	R7	R5	E2-D11	R15	R5	R7
LSB	G0		E1-D8	G16		G0
	G1		E1-D9	G17		G1
	G2	G0	E1-D10	G10	G0	G2
	G3	G1	E1-D11	G11	G1	G3
	G4	G2	E2-D0	G12	G2	G4
	G5	G3	E2-D1	G13	G3	G5
	G6	G4	E2-D2	G14	G4	G6
MSB	G7	G5	E2-D3	G15	G5	G7
LSB	B0		E1-D0	B16		B0
	B1		E1-D1	B17		B1
	B2	B0	E1-D2	B10	B0	B2
	B3	B1	E1-D3	B11	B1	B3
	B4	B2	E1-D4	B12	B2	B4
	B5	B3	E1-D5	B13	B3	B5
	B6	B4	E1-D6	B14	B4	B6
MSB	B7	B5	E1-D7	B15	B5	B7

LVDS Interface (Continued)

TABLE 7. Non-Conventional Data mapping for one 12-bit (two data per clock) single pixel in-to-dual pixel out application (DUAL = 1/2V_{CC}, Port1 A0-A3 and Port2 A4-A7 are active, BAL = Gnd)

VGA - TFT Data Signals Color Bits		Transmitter input pin names	Receiver output pin names	TFT Panel Data Signals	
	24-bit	DS90C2501	DS90CF388	18-bit	24-bit
Port 1-Primary (the first active RGB pixel)					
LSB	R0	E2-D4	R16		RO0
	R1	E2-D5	R17		RO1
	R2	E2-D6	R10	RO0	RO2
	R3	E2-D7	R11	RO1	RO3
	R4	E2-D8	R12	RO2	RO4
	R5	E2-D9	R13	RO3	RO5
	R6	E2-D10	R14	RO4	RO6
MSB	R7	E2-D11	R15	RO5	RO7
LSB	G0	E1-D8	G16		GO0
	G1	E1-D9	G17		GO1
	G2	E1-D10	G10	GO0	GO2
	G3	E1-D11	G11	GO1	GO3
	G4	E2-D0	G12	GO2	GO4
	G5	E2-D1	G13	GO3	GO5
	G6	E2-D2	G14	GO4	GO6
MSB	G7	E2-D3	G15	GO5	GO7
LSB	B0	E1-D0	B16		BO0
	B1	E1-D1	B17		BO1
	B2	E1-D2	B10	BO0	BO2
	B3	E1-D3	B11	BO1	BO3
	B4	E1-D4	B12	BO2	BO4
	B5	E1-D5	B13	BO3	BO5
	B6	E1-D6	B14	BO4	BO6
MSB	B7	E1-D7	B15	BO5	BO7
Port 2-Secondary (the second active RGB pixel)					
LSB	R0	E4-D4	R26		RE0
	R1	E4-D5	R27		RE1
	R2	E4-D6	R20	RE0	RE2
	R3	E4-D7	R21	RE1	RE3
	R4	E4-D8	R22	RE2	RE4
	R5	E4-D9	R23	RE3	RE5
	R6	E4-D10	R24	RE4	RE6
MSB	R7	E4-D11	R25	RE5	RE7
LSB	G0	E3-D8	G26		GE0
	G1	E3-D9	G27		GE1
	G2	E3-D10	G20	GE0	GE2
	G3	E3-D11	G21	GE1	GE3
	G4	E4-D0	G22	GE2	GE4
	G5	E4-D1	G23	GE3	GE5
	G6	E4-D2	G24	GE4	GE6
MSB	G7	E4-D3	G25	GE5	GE7
LSB	B0	E3-D0	B26		BE0
	B1	E3-D1	B27		BE1
	B2	E3-D2	B20	BE0	BE2

LVDS Interface (Continued)

TABLE 7. Non-Conventional Data mapping for one 12-bit (two data per clock)single pixel in-to-dual pixel out application (DUAL = $1/2V_{CC}$, Port1 A0-A3 and Port2 A4-A7 are active, BAL = Gnd) (Continued)

VGA - TFT Data Signals Color Bits		Transmitter input pin names	Receiver output pin names	TFT Panel Data Signals	
	B3	E3-D3	B21	BE1	BE3
	B4	E3-D4	B22	BE2	BE4
	B5	E3-D5	B23	BE3	BE5
	B6	E3-D6	B24	BE4	BE6
MSB	B7	E3-D7	B25	BE5	BE7

LVDS Interface (Continued)

TABLE 8. Non-Conventional Data Mapping for two 12-bit (two data per clock)dual pixel in-to-dual pixel out application (DUAL= V_{CC}, Port1 A0-A3 and Port2 A4-A7 are active, BAL= Gnd.)

VGA - TFT Data Signals Color Bits		Transmitter input pin names	Receiver output pin names	TFT Panel Data Signals	
	24-bit	DS90C2501	DS90CF388	18-bit	24-bit
Port 1-Primary (the first active RGB pixel)					
LSB	R0	E2-D4	R16		R0
	R1	E2-D5	R17		R1
	R2	E2-D6	R10	R0	R2
	R3	E2-D7	R11	R1	R3
	R4	E2-D8	R12	R2	R4
	R5	E2-D9	R13	R3	R5
	R6	E2-D10	R14	R4	R6
MSB	R7	E2-D11	R15	R5	R7
LSB	G0	E1-D8	G16		G0
	G1	E1-D9	G17		G1
	G2	E1-D10	G10	G0	G2
	G3	E1-D11	G11	G1	G3
	G4	E2-D0	G12	G2	G4
	G5	E2-D1	G13	G3	G5
	G6	E2-D2	G14	G4	G6
MSB	G7	E2-D3	G15	G5	G7
LSB	B0	E1-D0	B16		B0
	B1	E1-D1	B17		B1
	B2	E1-D2	B10	B0	B2
	B3	E1-D3	B11	B1	B3
	B4	E1-D4	B12	B2	B4
	B5	E1-D5	B13	B3	B5
	B6	E1-D6	B14	B4	B6
MSB	B7	E1-D7	B15	B5	B7
Port 2-Secondary (the second active RGB pixel)					
LSB	R0	E2-D16	R26		R0
	R1	E2-D17	R27		R1
	R2	E2-D18	R20	R0	R2
	R3	E2-D19	R21	R1	R3
	R4	E2-D20	R22	R2	R4
	R5	E2-D21	R23	R3	R5
	R6	E2-D22	R24	R4	R6
MSB	R7	E2-D23	R25	R5	R7
LSB	G0	E1-D20	G26		G0
	G1	E1-D21	G27		G1
	G2	E1-D22	G20	G0	G2
	G3	E1-D23	G21	G1	G3
	G4	E2-D12	G22	G2	G4
	G5	E2-D13	G23	G3	G5
	G6	E2-D14	G24	G4	G6
MSB	G7	E2-D15	G25	G5	G7
LSB	B0	E1-D12	B26		B0
	B1	E1-D13	B27		B1
	B2	E1-D14	B20	B0	B2

LVDS Interface (Continued)

TABLE 8. Non-Conventional Data Mapping for two 12-bit (two data per clock)dual pixel in-to-dual pixel out application (DUAL= V_{CC}, Port1 A0-A3 and Port2 A4-A7 are active, BAL= Gnd.) (Continued)

VGA - TFT Data Signals Color Bits		Transmitter input pin names	Receiver output pin names	TFT Panel Data Signals	
	B3	E1-D15	B21	B1	B3
	B4	E1-D16	B22	B2	B4
	B5	E1-D17	B23	B3	B5
	B6	E1-D18	B24	B4	B6
MSB	B7	E1-D19	B25	B5	B7

LVDS Interface (Continued)

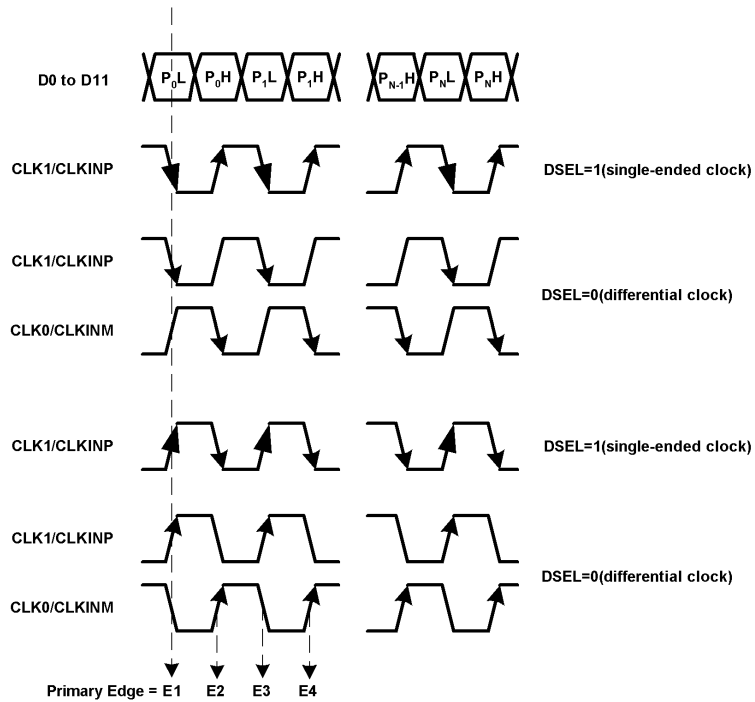

20004533

FIGURE 14. How Data is Latched in the DS90C2501

Note 12: The lower half of the pixel is latched by the primary clock edge E1.

Note 13: E3 and E4 only apply when DUAL pin = 1/2 V_{CC}.

Note 14: Above figure only valid when R_FDE bit = V_{CC}, DE signal from GUI is set to be active HIGH.

Note 15: D0 to D11 are clocked at the crossing point of CLKOUT+ and CLKOUT- when differential clock input is applied. This applies to D12 to D23 when DUAL pin = V_{CC}.

Note 16: Single-ended clock is not recommended for operation above 65MHz by GMCH vendor.

TABLE 9. 12-bit (two data per clock) input application data mapping with GMCH.

	P0		P1		P2	
	P0L	P0H	P1L	P1H	P2L	P2H
Pin Name	Low	High	Low	High	Low	High
D11	G0[3]	R0[7]	G1[3]	R1[7]	G2[3]	R2[7]
D10	G0[2]	R0[6]	G1[2]	R1[6]	G2[2]	R2[6]
D9	G0[1]	R0[5]	G1[1]	R1[5]	G2[1]	R2[5]
D8	G0[0]	R0[4]	G1[0]	R1[4]	G2[0]	R2[4]
D7	B0[7]	R0[3]	B1[7]	R1[3]	B2[7]	R2[3]
D6	B0[6]	R0[2]	B1[6]	R1[2]	B2[6]	R2[2]
D5	B0[5]	R0[1]	B1[5]	R1[1]	B2[5]	R2[1]
D4	B0[4]	R0[0]	B1[4]	R1[0]	B2[4]	R2[0]
D3	B0[3]	G0[7]	B1[3]	G1[7]	B2[3]	G2[7]
D2	B0[2]	G0[6]	B1[2]	G1[6]	B2[2]	G2[6]
D1	B0[1]	G0[5]	B1[1]	G1[5]	B2[1]	G2[5]
D0	B0[0]	G0[4]	B1[0]	G1[4]	B2[0]	G2[4]

Note 17: Color notation: R = RED, G = GREEN, B = BLUE.

Note 18: Bit significance within a color: [7:0] = [MSB:LSB].

LVDS Interface (Continued)

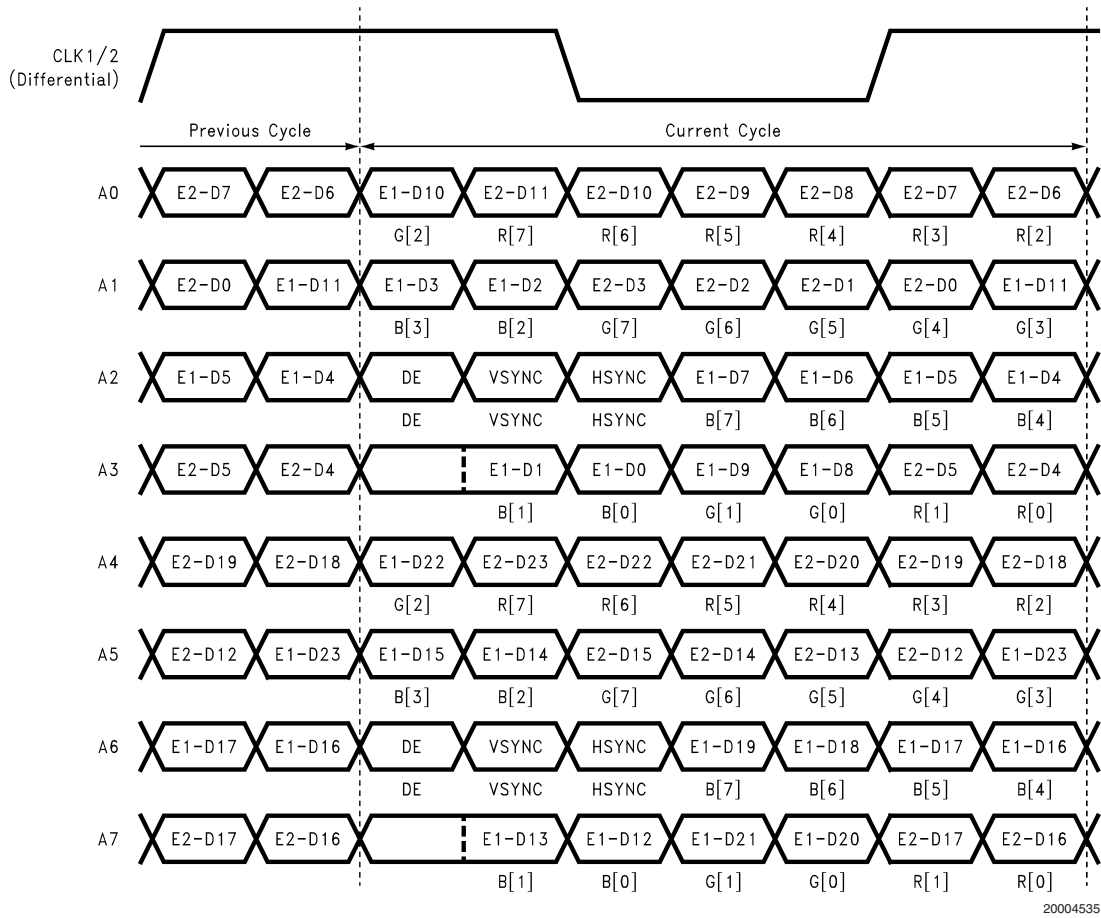

20004535

FIGURE 15. 24bit/48bit Conventional Data Inputs Mapped to LVDS Outputs
 (BAL = Gnd, DUAL = Gnd for A0 to A3-first pixel, DUAL = V_{CC} for A0 to A7-first pixel and second pixel)

LVDS Interface (Continued)

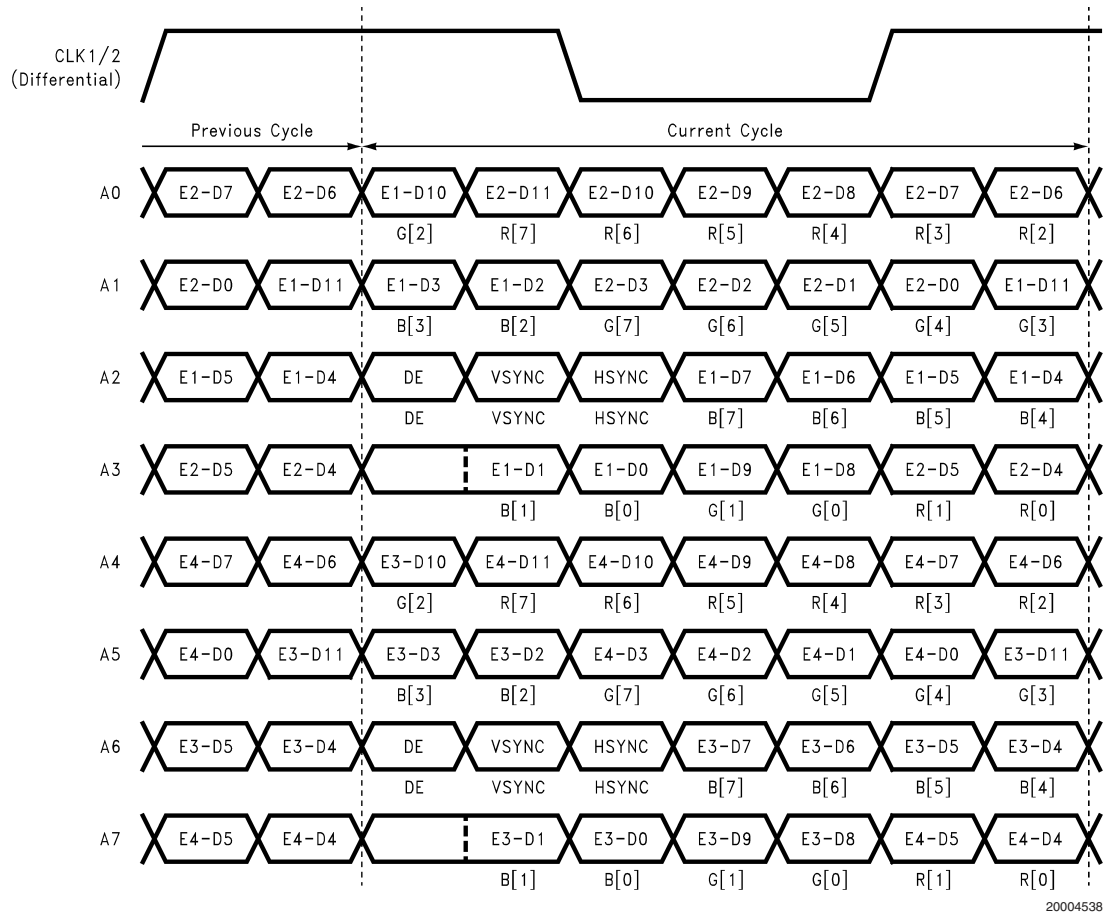

**FIGURE 16. 24bit/48bit Conventional Data Inputs Mapped to LVDS Outputs
(BAL = Gnd, DUAL = 1/2V_{CC} for A0 to A7-first pixel and second pixel)**

LVDS Interface (Continued)

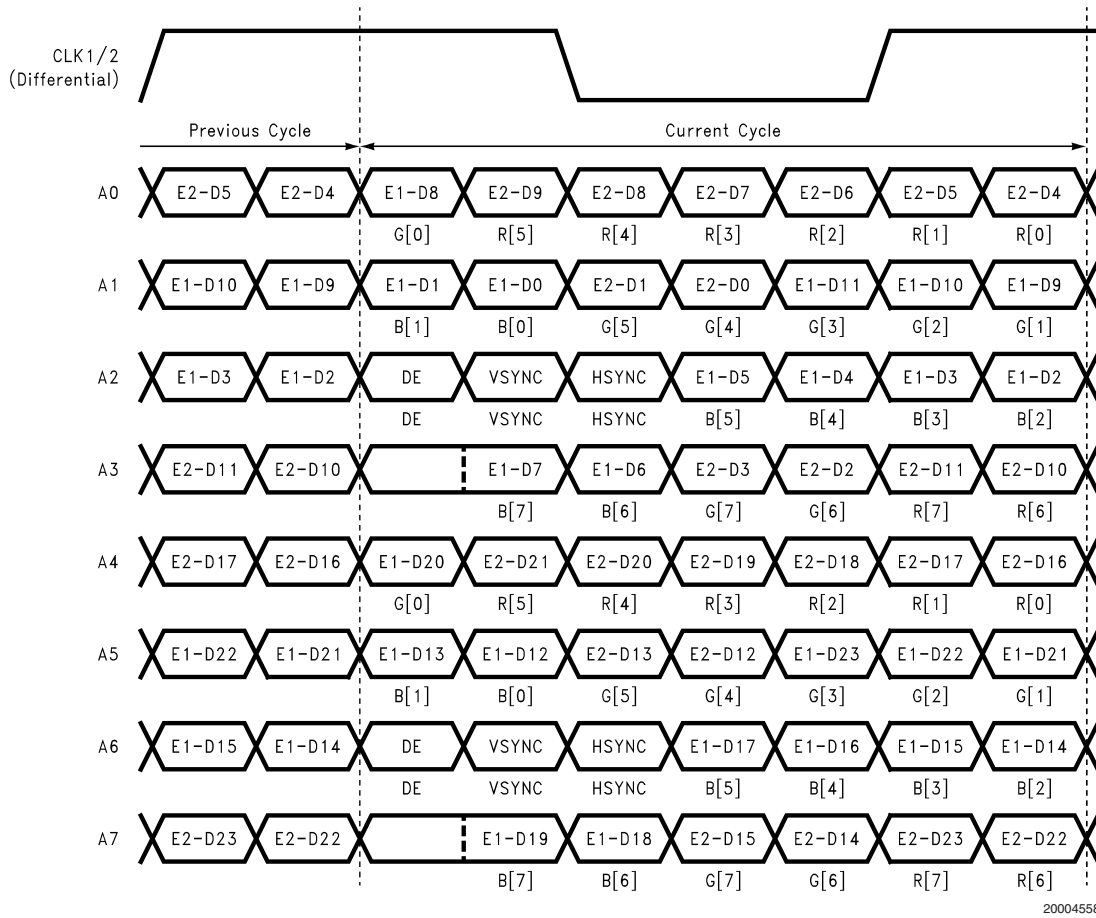

FIGURE 17. 24bit/48bit Non-Conventional Data Inputs Mapped to LVDS Outputs
(BAL = Gnd, DUAL = Gnd for A0 to A3-first pixel, DUAL = V_{CC} for A0 to A7-first pixel and second pixel)

LVDS Interface (Continued)

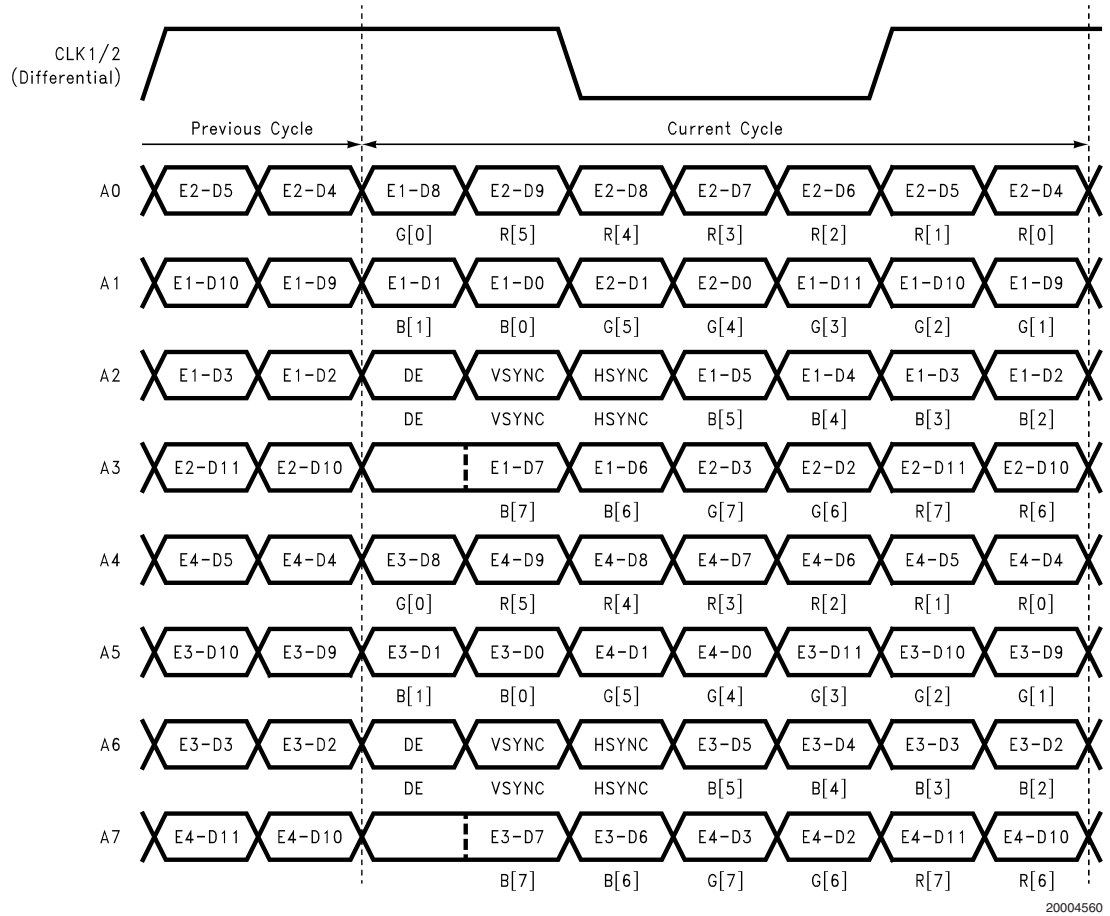

FIGURE 18. 24bit/48bit Non-Conventional Data Inputs Mapped to LVDS Outputs
(BAL = Gnd, DUAL = 1/2V_{CC} for A0 to A7-first pixel and second pixel)

Scaler Information

DVO Input and Bypass Mode:

The input single port DVO data is translated into 18bit/24bit RGB data for scaling. Single port data over 108MHz or dual port data will be bypassed and not scaled. The LVDS output can be single or dual port.

Input Timing Control:

The DS90C2501 input timing control can detect the input timing information such as horizontal and vertical sync width, pixel-total and line-total count and the active video starting and ending positions. Such information can be provided to the host through two-wire serial communication Interface to help determine the input mode.

Display Synchronization

The DS90C2501 synchronizes the display timing with input graphics timing so that no external frame buffer is needed. There are three operation modes:

Free-run mode: No synchronization. Output timing is generated from external 14.318MHz reference clock.

Line lock mode: the display Hsync is synchronized with the input line rate.

Frame lock mode: the display Vsync is synchronized with the input frame rate.

In free-run mode, the display timing is decided by the values programmed into the various timing registers. In line-lock mode, the display line rate is a function of the selected input clock, forcing the output frame rate to be locked to input

frame rate. Timing management is more complicated. The frame-lock mode is used more often. The output pixel clock and Hsync are generated from the external 14.318MHz reference clock and the embedded PLL, but the Vsync is refreshed at the input frame rate.

Gamma Look-up Table (LUT):

The DS90C2501 provides an 8-bit look-up-table (LUT) for each input color channel in case gamma correction is needed. The LUT is user programmable to provide an arbitrary transfer function.

The transmitter is offered with programmable edge data strobes for convenient interface with a variety of graphics controllers. The transmitter can be programmed for rising edge strobe or falling edge strobe through a dedicated pin. A rising edge transmitter will inter-operate with a falling edge receiver without any translation logic.

Output Timing Control:

The DS90C2501 output timing is fully programmable through two-wire serial communication Interface for different panel requirements. When 6-bit color LCD is used, dithering (FRC) can be turned on via two-wire serial communication programming interface. The least two LSB of each color are default to be logic low all the time. When 8-bit color LCD is used, dithering (FRC) is not needed, and can be turned off via two-wire serial communication programming interface.

See DS90C2501 guide for further information on programming these features.

Scaler Information (Continued)

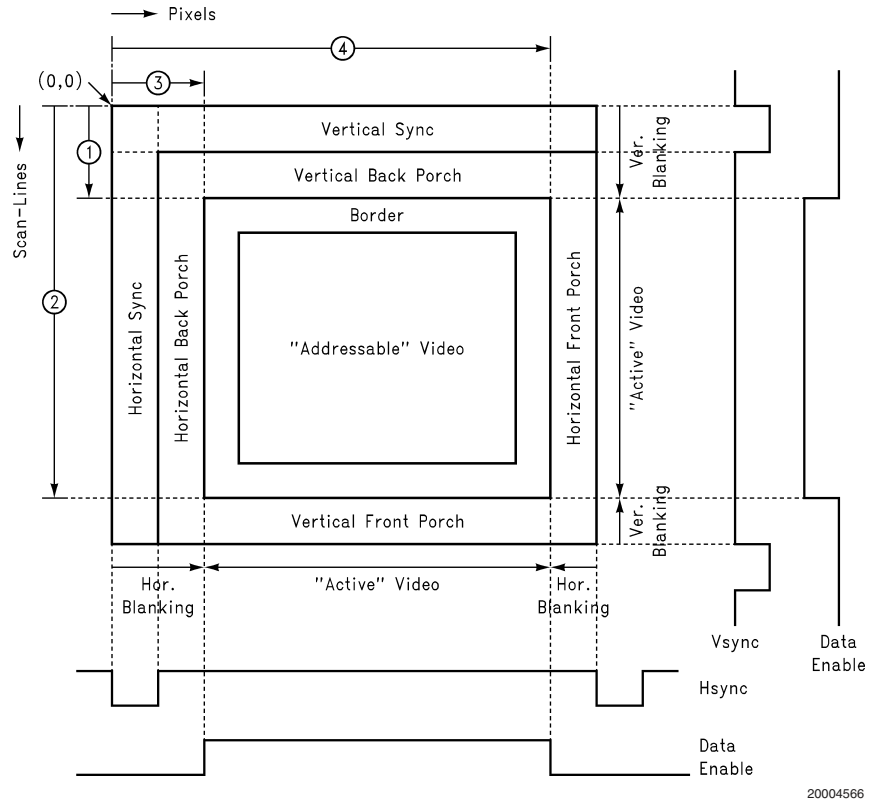

1	Vertical Scaling Region Start
2	Vertical Scaling Region End
3	Horizontal Scaling Region Start
4	Horizontal Scaling Region End

FIGURE 19. Input Timing of DS90C2501 scaler 1 of 2

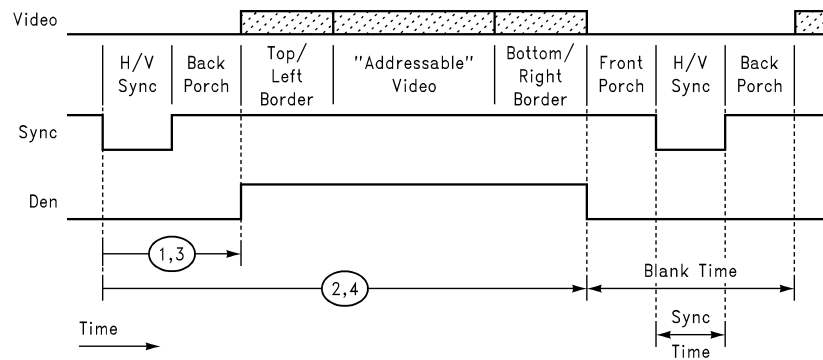
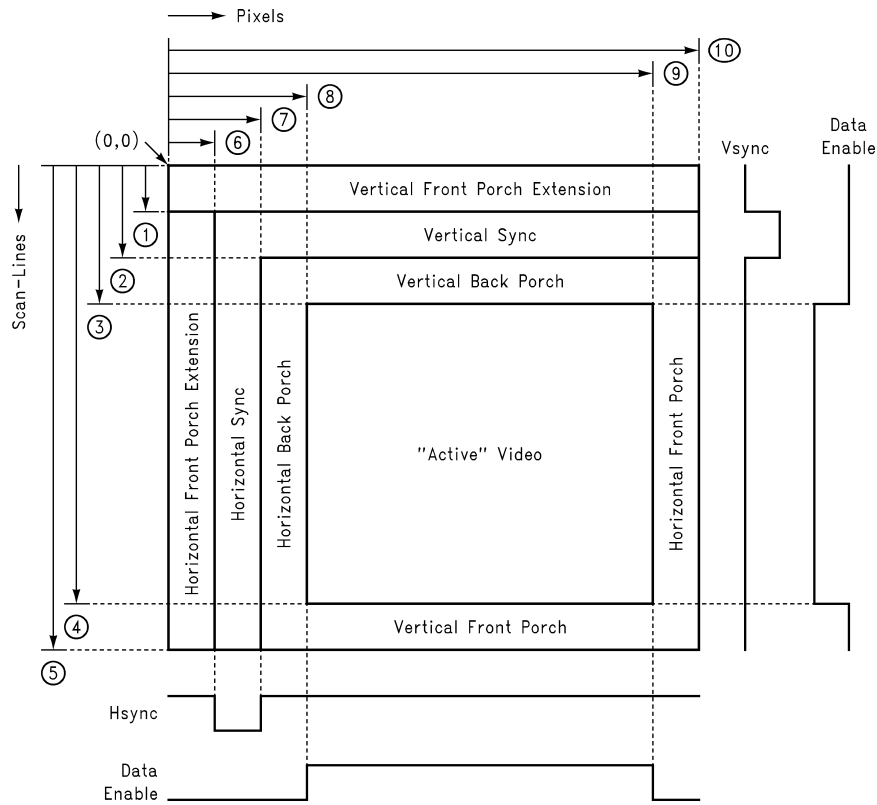

FIGURE 20. Input Timing of DS90C2501 scaler 2 of 2

Scaler Information (Continued)



20004568

1	Vsync start.
2	Vsync end.
3	Vertical action region start.
4	Vertical action region end.
5	Total vertical scan-lines in a frame.
6	Hsync start.
7	Hsync end.
8	Horizontal active region start.
9	Horizontal active region end.
10	Total horizontal pixels in a scan-line.

FIGURE 21. Display Signal Timing of DS90C2501 scaler 1 of 2

Scaler Information (Continued)

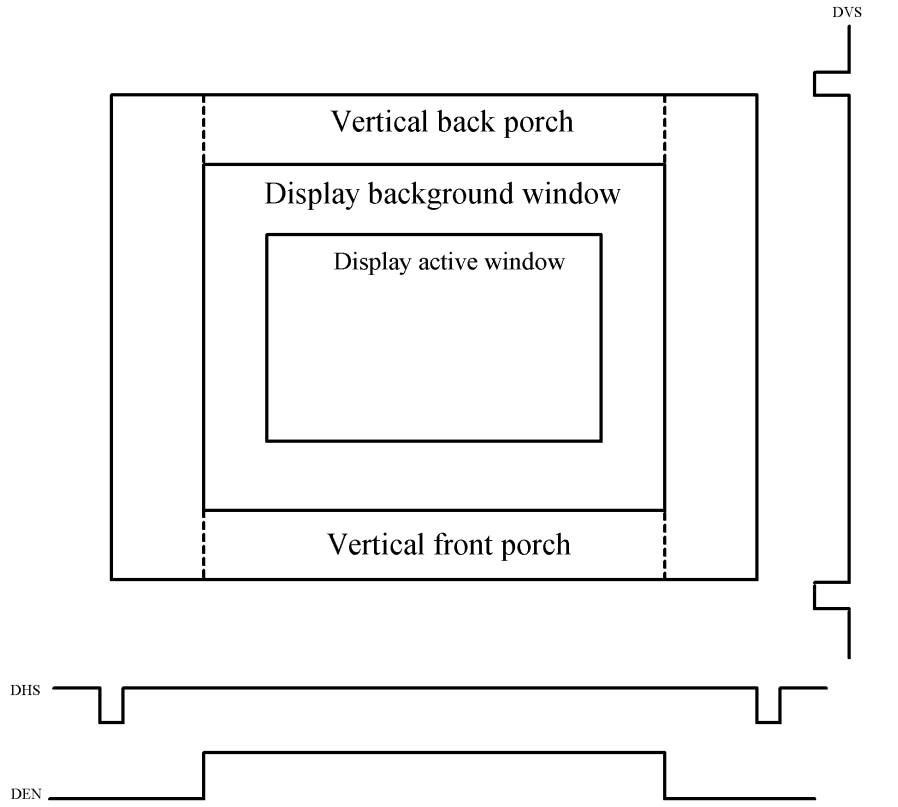

20004557

FIGURE 22. Display Signal Timing of DS90C2501 scaler 2 of 2

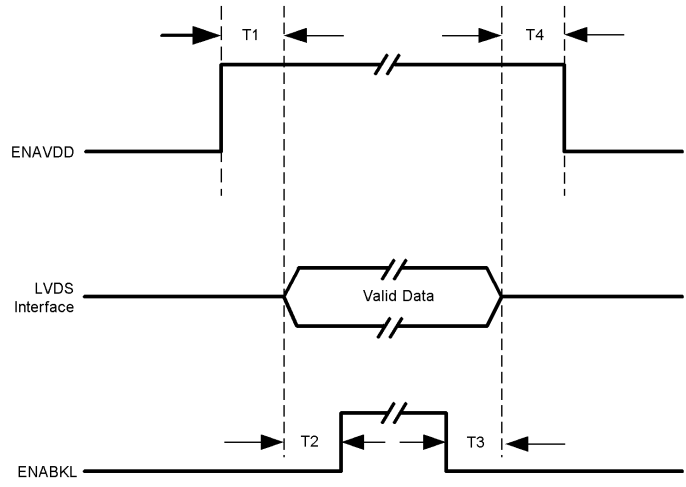

20004562

FIGURE 23. Sample LCD Power Up Sequence

Applications Information

How to configure the DS90C2501 with DS90C364 or DS90CF364A or DS90CF366 for most common application:

1. To configure for single pixel in to single pixel out application using the DS90C2501 with DS90CF364 or DS90CF364A or DS90CF366, the "DUAL" pin must be set to Gnd (single). In this mode, outputs A0-to-A3 and CLK1 are enabled, and outputs A4-to-A7 and CLK2 are disabled which reduces power dissipation.

Features Description:

2. Programmable Primary Edge E1: The transmitter is latching data on both the rising and falling edges of clock signal coming in on CLKINP pin. The EDGE pin can be used to program to select the rising edge of CLKINP as the primary edge E1 or to have the falling edge of CLKINP as the primary edge E1. However, the logic state of the EDGE pin must agree with the GUI to generate the correct display.

TABLE 10. Connection for SISO Operation

From DS90C2501	To GMCH
RGB data signal connection	
D0	DVOxDATA0
D1	DVOxDATA1
D2	DVOxDATA2
D3	DVOxDATA3
D4	DVOxDATA4
D5	DVOxDATA5
D6	DVOxDATA6
D7	DVOxDATA7
D8	DVOxDATA8
D9	DVOxDATA9
D10	DVOxDATA10
D11	DVOxDATA11
D12 to D23	GND
CLKINP	DVOxCLKOUT1
CLKINM	DVOxCLKOUT0
DE	DVOxBLANK
HSYNC	DVOxHSYNC
VSYNC	DVOxVYSNC
connection for other pins	
DUAL	GND
EDGE	GND
BAL	GND
A0	Pull Up/Pull Down, Based on Device Address
A1	Pull Up/Pull Down, Based on Device Address
A2	Pull Up/Pull Down, Based on Device Address
ID0	Pull Up/Pull Down, Based on Panel ID
ID1	Pull Up/Pull Down, Based on Panel ID
ID2	Pull Up/Pull Down, Based on Panel ID
ID3	Pull Up/Pull Down, Based on Panel ID
RES1	GND
RES2	GND
RES3	GND
RES4	GND
TST1	GND
TST2	GND
TST3	GND
S2Cclk	I2CCLK
S2Cdat	I2CDATA
REFCLK	3V 14.31818MHz
COLOR	GND

Applications Information (Continued)**TABLE 10. Connection for SISO Operation** (Continued)

$\overline{\text{PD}}$	DVCC or equivalent
$\overline{\text{RSETN}}$	DVCC or equivalent
VREF	$\frac{1}{2}V_{\text{DDQ}}$ of GMCH

Applications Information (Continued)

see *Table 10*. The “DUAL” pin must be set to Gnd. In this mode, outputs A0-to-A7, and CLK1, CLK2 are enabled.

3. To configure for single pixel in to dual pixel out application using the DS90C2501 for Single-In-Single-Out operation,

TABLE 11. Connection for SIDO Operation

From DS90C2501	To GMCH
RGB data signal connection	
D0	DVOxDATA0
D1	DVOxDATA1
D2	DVOxDATA2
D3	DVOxDATA3
D4	DVOxDATA4
D5	DVOxDATA5
D6	DVOxDATA6
D7	DVOxDATA7
D8	DVOxDATA8
D9	DVOxDATA9
D10	DVOxDATA10
D11	DVOxDATA11
D12 to D23	GND
CLKINP	DVOxCLKOUT1
CLKINM	DVOxCLKOUT0
DE	DVOxBLANK
HSYNC	DVOxHSYNC
VSYNC	DVOxVYSNC
connection for other pins	
DUAL	$\frac{1}{2}VCC$
EDGE	GND
BAL	GND
A0	Pull Up/Pull Down, Based on Device Address
A1	Pull Up/Pull Down, Based on Device Address
A2	Pull Up/Pull Down, Based on Device Address
ID0	Pull Up/Pull Down, Based on Panel ID
ID1	Pull Up/Pull Down, Based on Panel ID
ID2	Pull Up/Pull Down, Based on Panel ID
ID3	Pull Up/Pull Down, Based on Panel ID
RES1	GND
RES2	GND
RES3	GND
RES4	GND
TST1	GND
TST2	GND
TST3	GND
S2Cclk	I2CCLK
S2Cdat	I2CDATA
REFCLK1	3V 14.31818MHz
COLOR	GND
PD	DVCC or equivalent
RSETN	DVCC or equivalent
VREF	$\frac{1}{2}V_{DDQ}$ of GMCH

Applications Information (Continued)

4. To configure for dual pixel in to dual pixel out application using the DS90C2501 with DS90CF364 or DS90CF364A or DS90CF366, the "DUAL" pin must be set to V_{CC} . In this mode, outputs A0-to-A7, and CLK1, CLK2 are enabled. Do note that scaler will be shut down in this configuration.

Board Layout and Thermal Considerations for the DS90C2501

Note: The thermal information listed in this document is based on preliminary simulation results and subject to change.

The thermal enhancement features of the (CSP) chip scale package require special considerations and guidelines to be observed to insure optimal thermal performance in applications where the cooling method is free-air convection.

The CSP128 package has a 5X5 matrix of thermal pads designed to efficiently conduct heat from the device to the plane of the printed circuit board. The package requires this thermal connection to increase the effective surface area of the package to maintain safe operating die temperatures. The vias of the thermal pads should be connected to the board's ground plane having a minimum effective area of 2000 mm².

For more complex system thermal design situations, it is recommended that system level thermal analysis tools be utilized to insure the maximum junction temperature is not exceeded.

The graph in *Figure 24* shows the expected junction temperature for a given plane area under varying ambient temperature conditions. *Figure 25* shows the recommended PCB footprint for the DS90C2501. The following assumptions were used:

- Board Thickness = 1.6mm
- Board Area = 7742 sq. mm
- Copper Plane = 1 oz.
- Number of layers = 4
- Signal Trace Length = 25.4mm
- Maximum Junction Temperature = +150°C
- Package θ_{JA} = 31.7°C/W (Natural Convection)
- The example does not take heating effects from adjacent system components into consideration.
- Pd (max) = 1.8W*

*(scaler on, SXGA to SXGA+ scaling, single in -dual output port mode, $V_{DD2.5}$ +10%, $V_{DD3.3}$ +10%, max. process variation)

As a final design verification, the temperature at the top-center of the case (T_{CASE}) should not exceed 97°C.

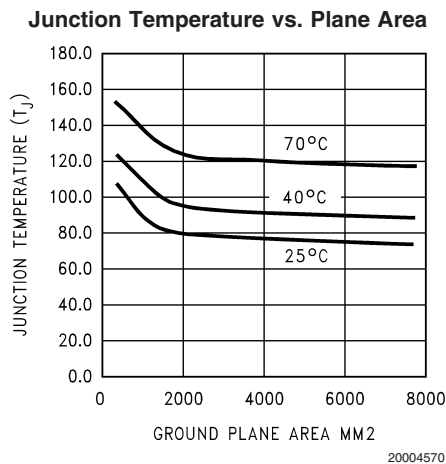
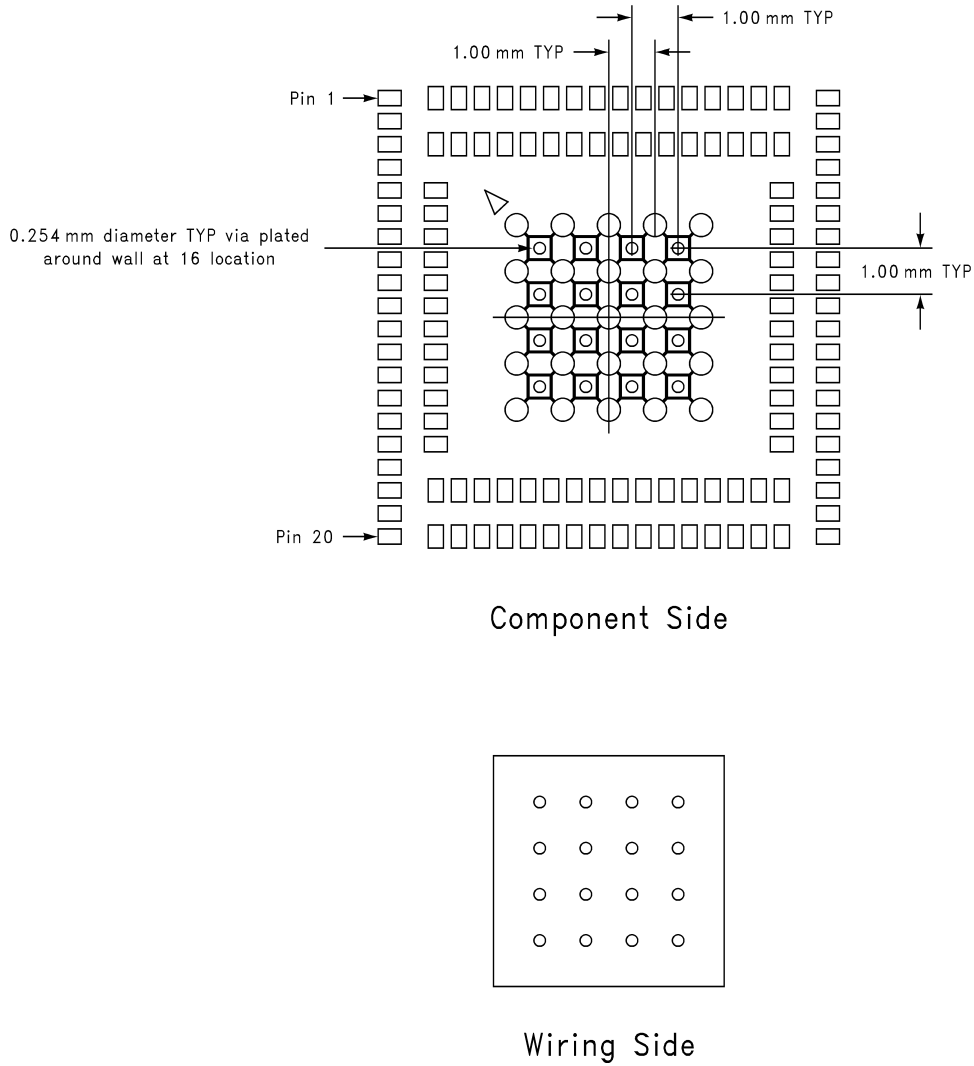

FIGURE 24. Junction Temperature vs. Ground Plane Area

Applications Information (Continued)



20004571

FIGURE 25. Recommended Land Pattern Component Side (1) and Wiring Side (2) of Board with Thermal Pads Connected to Ground Plane of PCB.

Pin Diagram

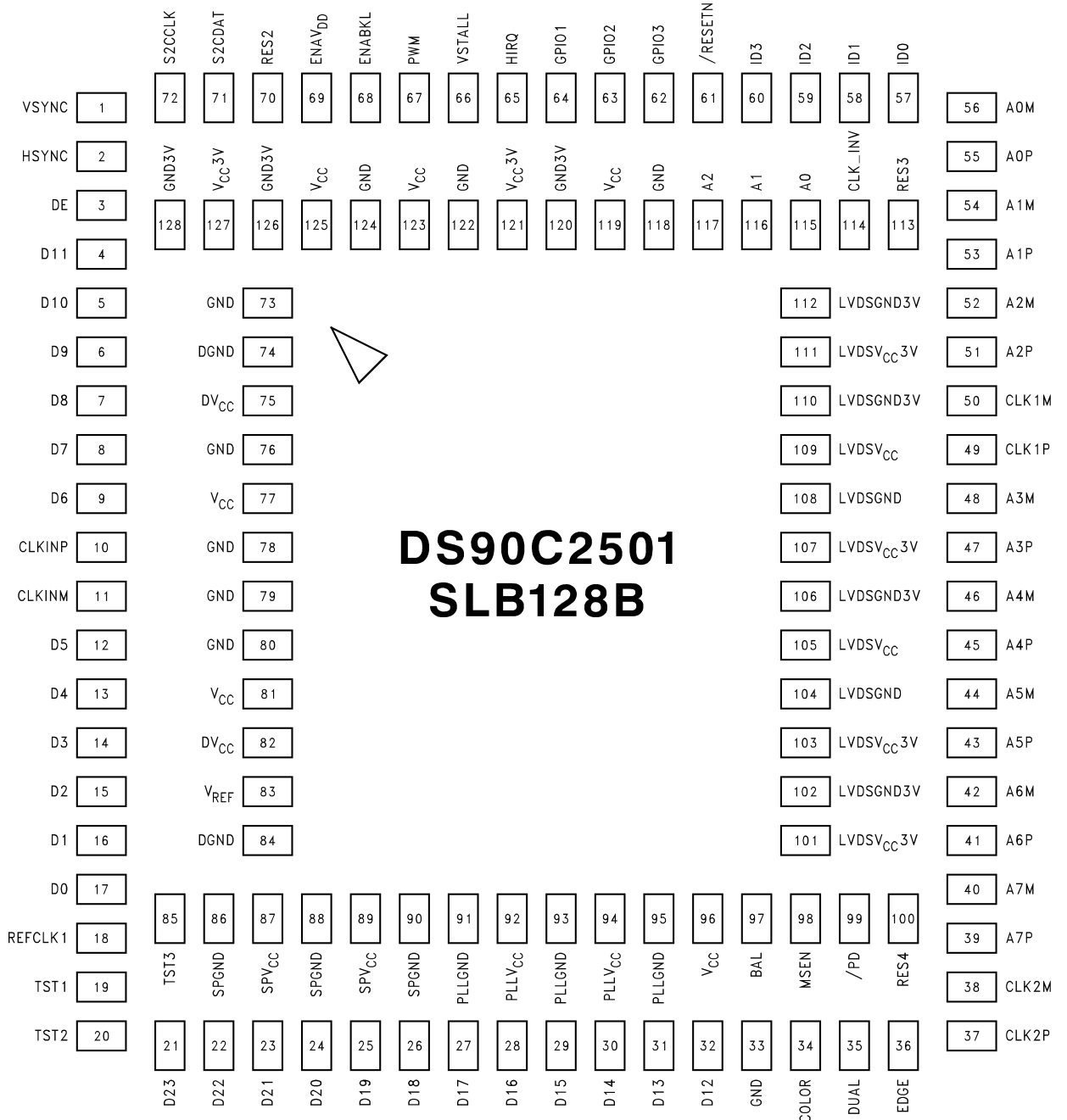

**DS90C2501
SLB128B**

Top View of DS90C2501

Physical Dimensions inches (millimeters) unless otherwise noted

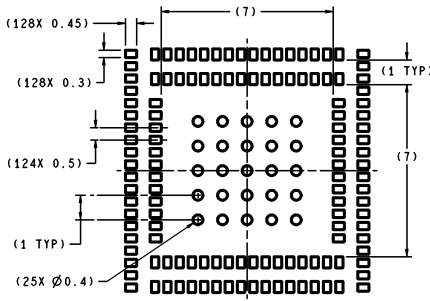

RECOMMENDED LAND PATTERN
1:1 RATIO WITH PACKAGE SOLDER PADS

DIMENSIONS ARE IN MILLIMETERS

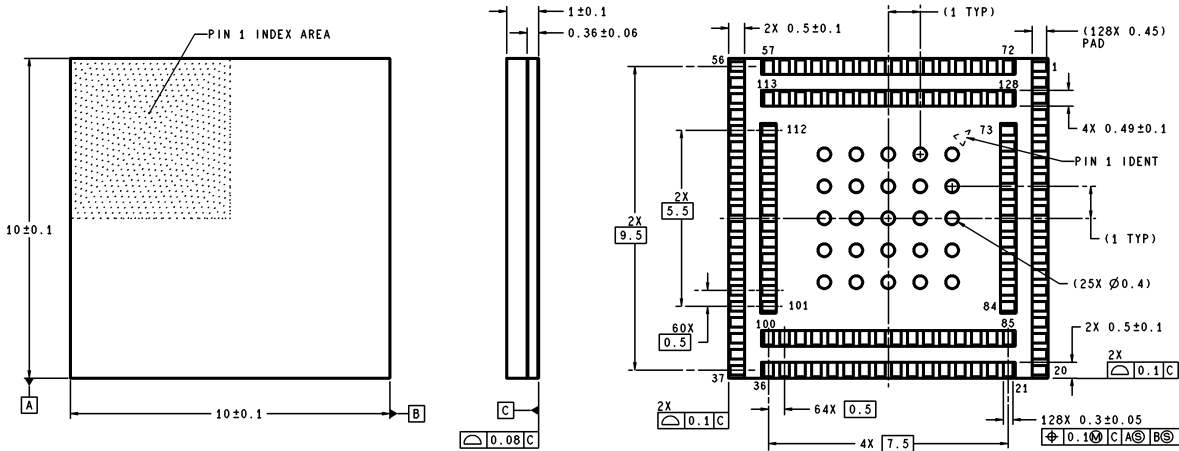

SLB128B (Rev B)

Dimensions show in millimeters
 Order Number DS90C2501SLB
 NS Package Number SLB128B
 Refer to Application Note AN1125 for more information

LIFE SUPPORT POLICY

NATIONAL'S PRODUCTS ARE NOT AUTHORIZED FOR USE AS CRITICAL COMPONENTS IN LIFE SUPPORT DEVICES OR SYSTEMS WITHOUT THE EXPRESS WRITTEN APPROVAL OF THE PRESIDENT AND GENERAL COUNSEL OF NATIONAL SEMICONDUCTOR CORPORATION. As used herein:

1. Life support devices or systems are devices or systems which, (a) are intended for surgical implant into the body, or (b) support or sustain life, and whose failure to perform when properly used in accordance with instructions for use provided in the labeling, can be reasonably expected to result in a significant injury to the user.
2. A critical component is any component of a life support device or system whose failure to perform can be reasonably expected to cause the failure of the life support device or system, or to affect its safety or effectiveness.

BANNED SUBSTANCE COMPLIANCE

National Semiconductor certifies that the products and packing materials meet the provisions of the Customer Products Stewardship Specification (CSP-9-111C2) and the Banned Substances and Materials of Interest Specification (CSP-9-111S2) and contain no "Banned Substances" as defined in CSP-9-111S2.



National Semiconductor
 Americas Customer
 Support Center
 Email: new.feedback@nsc.com
 Tel: 1-800-272-9959

National Semiconductor
 Europe Customer Support Center
 Fax: +49 (0) 180-530 85 86
 Email: europe.support@nsc.com
 Deutsch Tel: +49 (0) 69 9508 6208
 English Tel: +44 (0) 870 24 0 2171
 Français Tel: +33 (0) 1 41 91 8790

National Semiconductor
 Asia Pacific Customer
 Support Center
 Email: ap.support@nsc.com

National Semiconductor
 Japan Customer Support Center
 Fax: 81-3-5639-7507
 Email: jpn.feedback@nsc.com

DS90C2501 Transmitter with built-in scaler for LVDS Display Interface (LDI)

www.national.com

Tel: 81-3-5639-7560