

### Bias Resistor Transistor PNP Silicon

**(Pb)** Lead(Pb)-Free

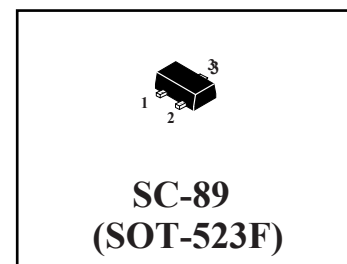
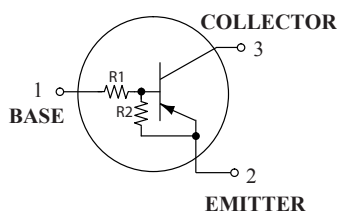

### Maximum Ratings (TA=25°C unless otherwise noted)

Rating	Symbol	Value	Unit
Collector-Emitter Voltage	V <sub>CEO</sub>	50	V
Collector-Base Voltage	V <sub>CBO</sub>	50	V
Collector Current-Continuous	I <sub>C</sub>	100	mA

### Thermal Characteristics

Characteristics	Symbol	Max	Unit
Total Device Dissipation FR-5 Board FR-4 Board <sup>(1)</sup> T <sub>A</sub> =25°C Derate above 25°C	P <sub>D</sub>	200 1.6	mW mW/°C
Thermal Resistance, Junction to Ambient <sup>(1)</sup>	R <sub>θJA</sub>	600	°C/W
Total Device Dissipation FR-5 Board FR-4 Board <sup>(2)</sup> T <sub>A</sub> =25°C Derate above 25°C	P <sub>D</sub>	300 2.4	mW mW/°C
Thermal Resistance, Junction to Ambient <sup>(2)</sup>	R <sub>θJA</sub>	400	°C/W
Junction Temperature Range	T <sub>J</sub>	-55 to +150	°C
Storage Temperature Range	T <sub>stg</sub>	-55 to +150	°C

1.FR-4 @ Minimum pad

2.FR-4 @1.0 x 1.0 Inch pad

### Device Marking and Resistor Values

Device	Marking	R1(K)	R2(K)
DTA114EE	6A	10	10
DTA124EE	6B	22	22
DTA144EE	6C	47	47
DTA114YE	6D	10	47
DTA114TE	6E	10	∞
DTA143TE	6F	4.7	∞

Device	Marking	R1(K)	R2(K)
DTA123EE	6H	2.2	2.2
DTA143EE	43	4.7	4.7
DTA143ZE	6K	4.7	47
DTA124XE	6L	22	47
DTA123JE	6M	2.2	47
DTA115EE	6N	100	100
DTA144WE	6P	47	22

**Electrical Characteristics** ( $T_A=25^\circ\text{C}$  Unless Otherwise noted)

Characteristics	Symbol	Min	Typ	Max	Unit
-----------------	--------	-----	-----	-----	------

**Off Characteristics**

Collector-Emitter Breakdown Voltage <sup>(2)</sup> $I_C=2.0\text{mA}, I_B=0$	$V_{(BR)CEO}$	50	-	-	V
Collector-Base Breakdown Voltage $I_C=10\mu\text{A}, I_E=0$	$V_{(BR)CBO}$	50	-	-	V
Collector-Base Cutoff Voltage $V_{CB}=50\text{V}, I_E=0$	$I_{CBO}$	-	-	100	nA
Collector-Emitter Cutoff Current $V_{CE}=50\text{V}, I_B=0$	$I_{CEO}$	-	-	500	nA
Emitter-Base Cutoff Current $V_{EB}=6.0\text{V}, I_C=0$					
	DTA114EE	-	-	0.5	mA
	DTA124EE	-	-	0.2	
	DTA144EE	-	-	0.1	
	DTA114YE	-	-	0.2	
	DTA114TE	-	-	0.9	
	DTA143TE	-	-	1.9	
	DTA123EE	-	-	2.3	
	DTA143EE	-	-	1.5	
	DTA143ZE	-	-	0.18	
	DTA124XE	-	-	0.13	
	DTA123JE	-	-	0.2	
	DTA115EE	-	-	0.05	
	DTA144WE	-	-	0.13	

2. Pulse Test: Pulse Width < 300us, Duty Cycle < 2.0%

## Electrical Characteristics (TA=25°C Unless Otherwise noted)

Characteristics	Symbol	Min	Typ	Max	Unit	
<b>On Characteristics<sup>(3)</sup></b>						
DC Current Gain $V_{CE}=-10V, I_C=5.0mA$	DTA114EE DTA124EE DTA144EE DTA114YE DTA114TE DTA143TE DTA123EE DTA143EE DTA143ZE DTA124XE DTA123JE DTA115EE DTA144WE	$h_{FE}$	35 60 80 80 160 160 8.0 15 80 80 80 80 80	60 100 140 140 250 250 15 27 140 130 140 150 140	- - - - - - - - - - - - -	-
Collector-Emitter Saturation Voltage $I_C=10mA, I_E=0.3mA$ $I_C=10mA, I_E=5.0mA$ $I_C=10mA, I_E=1.0mA$	DTA123EE DTA114TE / DTA143TE DTA143ZE / DTA124XE DTA143EE	$V_{CE(sat)}$	-	-	0.25	-
Output Voltage(on) $V_{CC}=5.0V, V_B=2.5V R_L=1.0K\Omega$  $V_{CC}=5.0V, V_B=3.5V R_L=1.0K\Omega$ $V_{CC}=5.0V, V_B=5.5V R_L=1.0K\Omega$ $V_{CC}=5.0V, V_B=4.0V R_L=1.0K\Omega$	DTA114EE DTA124EE DTA144EE DTA114YE DTA114TE DTA143TE DTA123EE DTA143EE DTA143ZE DTA124XE DTA123JE DTA115EE DTA144WE	$V_{OL}$	-	-	0.2	V

3. Pulse Test: Pulse Width < 300us, Duty Cycle < 2.0%

**Electrical Characteristics** (TA=25°C Unless Otherwise noted)

Characteristics	Symbol	Min	Typ	Max	Unit
<b>On Characteristics<sup>(4)</sup></b> Output Voltage(off) V <sub>CC</sub> =5.0V, V <sub>B</sub> =0.5V R <sub>L</sub> =1.0KΩ V <sub>CC</sub> =5.0V, V <sub>B</sub> =0.25V R <sub>L</sub> =1.0KΩ DTA114TE DTA143TE DTA123EE DTA143EE	V <sub>OH</sub>	4.9	-	-	V
Input Resistor DTA114EE DTA124EE DTA144EE DTA114YE DTA114TE DTA143TE DTA123EE DTA143EE DTA143ZE DTA124XE DTA123JE DTA115EE DTA144WE	R1	7.0 15.4 32.9 7.0 7.0 3.3 1.5 3.3 3.3 15.4 15.4 70 32.9	10 22 47 10 10 4.7 2.2 4.7 4.7 22 2.2 100 47	13 28.6 61.1 13 13 6.1 2.9 6.1 6.1 28.6 2.86 130 61.1	kΩ
Resistor Ratio DTA114EE / DTA124EE DTA144EE / DTA115EE DTA114YE DTA114TE / DTA143TE DTA123EE / DTA143EE DTA143ZE DTA124XE DTA123JE DTA144WE	R1/R2	0.8 0.17 - 0.8 0.055 0.38 0.038 1.7	1.0 0.21 - 1.0 0.1 0.47 0.047 2.1	1.2 0.25 - 1.2 0.185 0.56 0.056 2.6	-

4. PulseTest: Pulse Width &lt; 300us, Duty Cycle &lt; 2.0%

DTA114EET1 Series

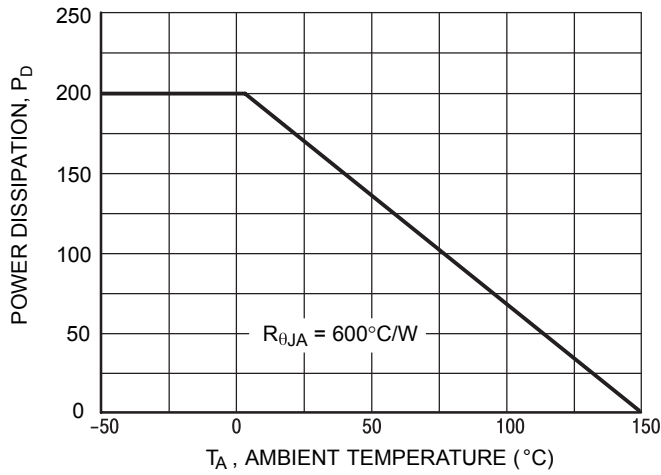

Figure 1. Derating Curve

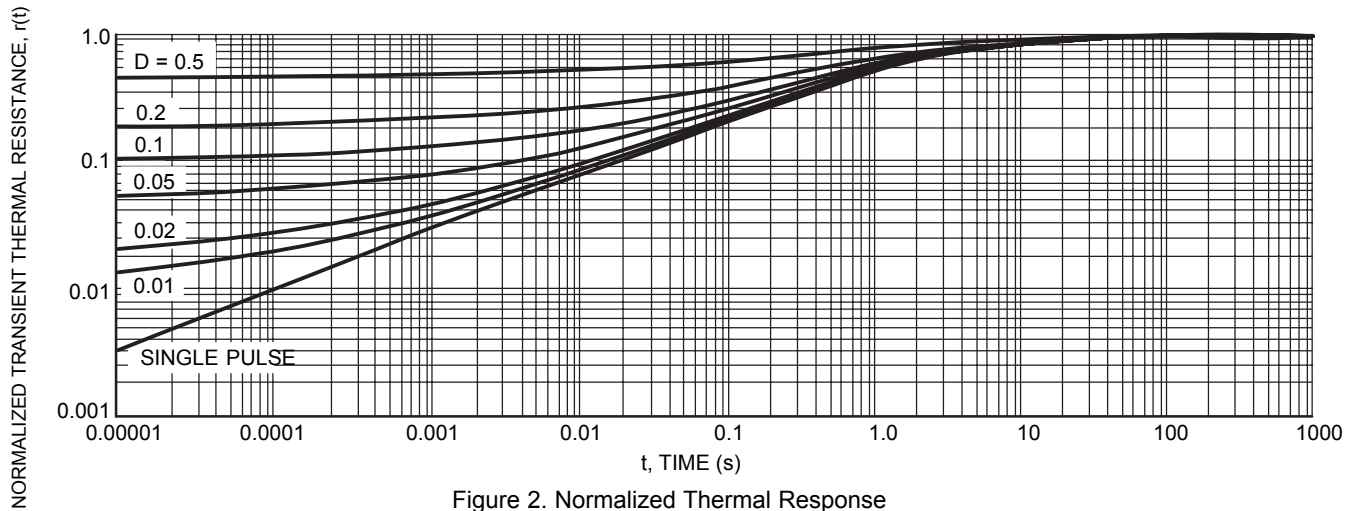

Figure 2. Normalized Thermal Response

TYPICAL ELECTRICAL CHARACTERISTICS – DTA114EE1

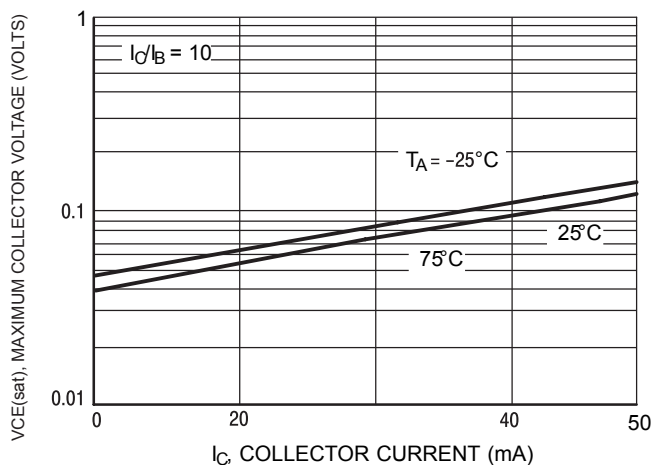

Figure 3.  $V_{CE(sat)}$  versus  $I_C$

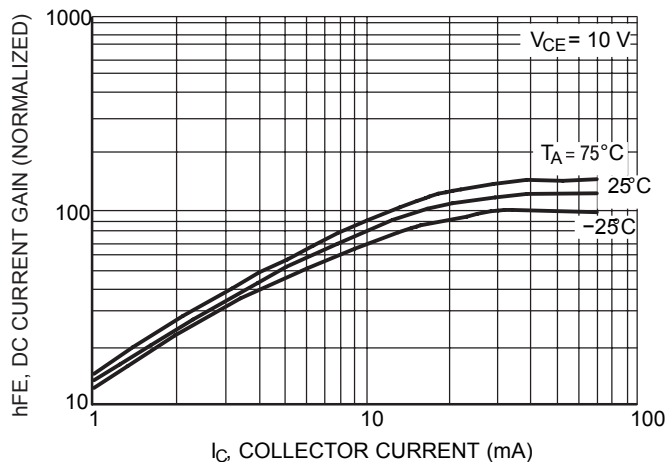

Figure 4. DC Current Gain

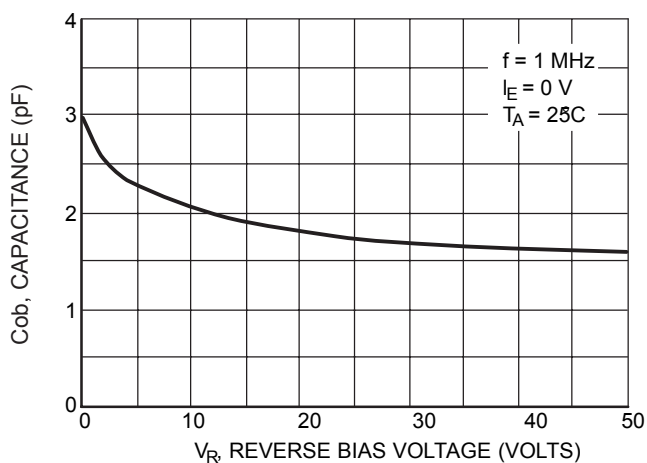

Figure 5. Output Capacitance

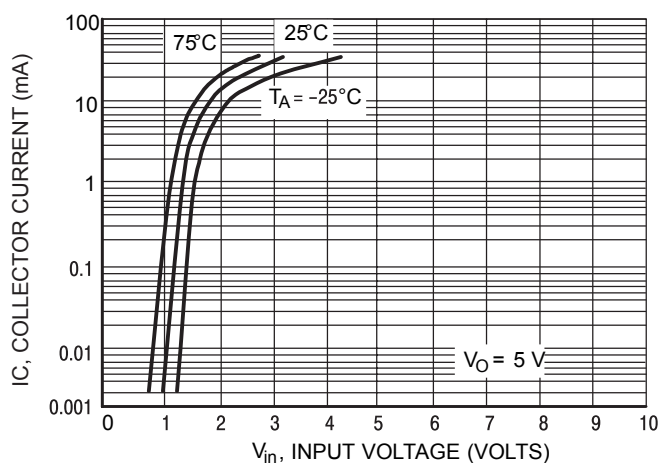

Figure 6. Output Current versus Input Voltage

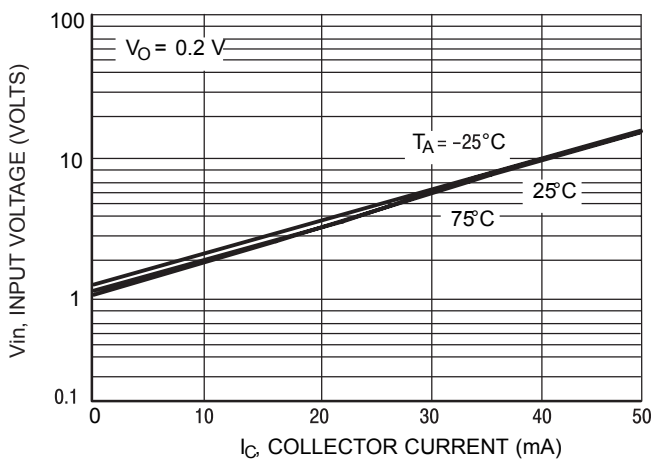

Figure 7. Input Voltage versus Output Current

TYPICAL ELECTRICAL CHARACTERISTICS – DTA123EET1

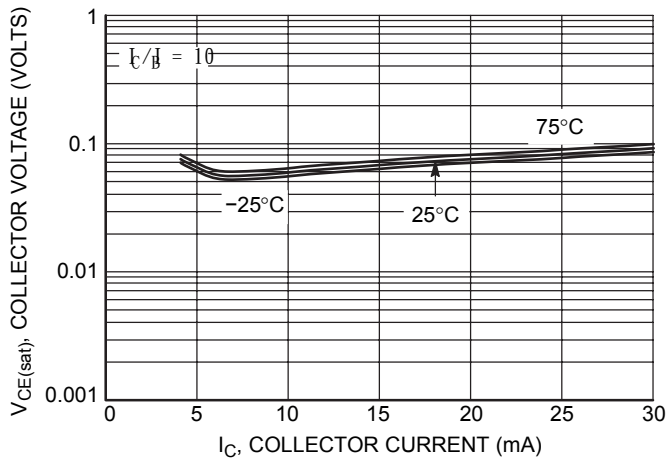

Figure 8.  $V_{CE(sat)}$  versus  $I_C$

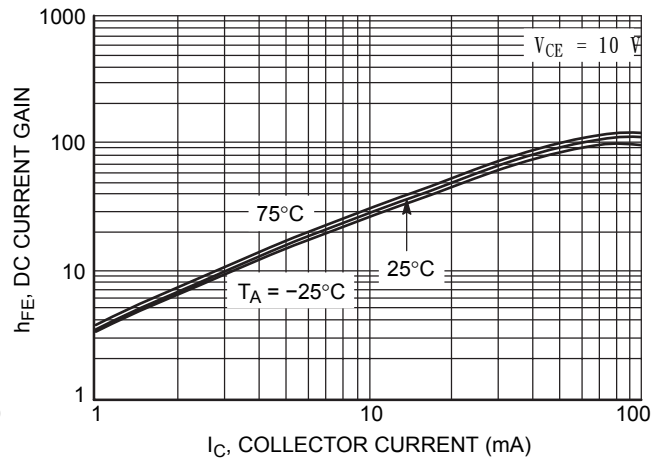

Figure 9. DC Current Gain

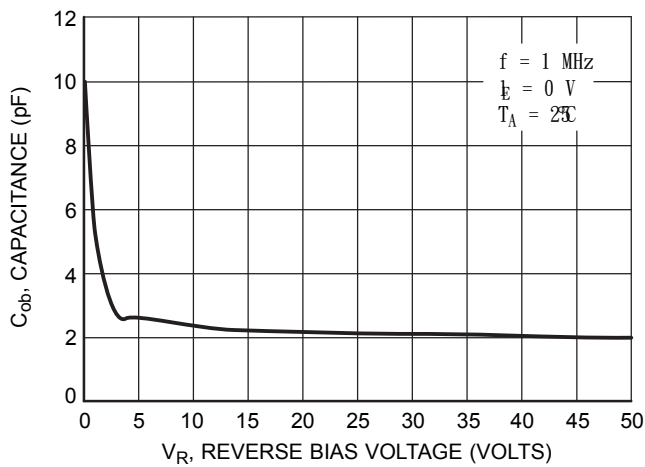

Figure 10. Output Capacitance

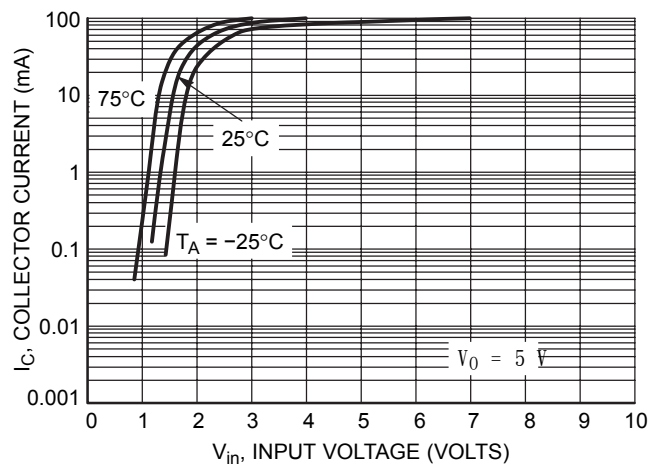

Figure 11. Output Current versus Input Voltage

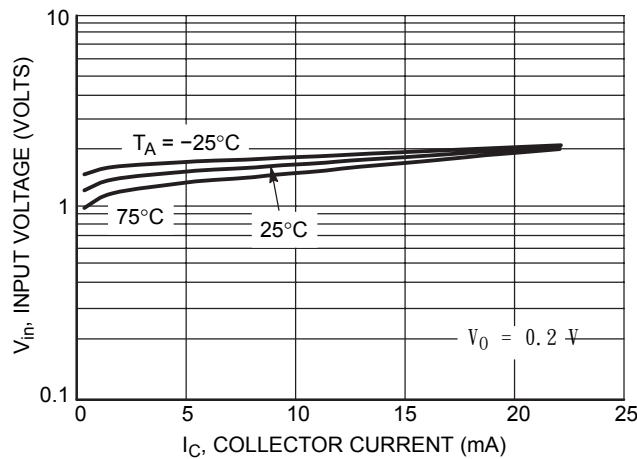

Figure 12. Input Voltage versus Output Current

TYPICAL ELECTRICAL CHARACTERISTICS - DTA124EE1

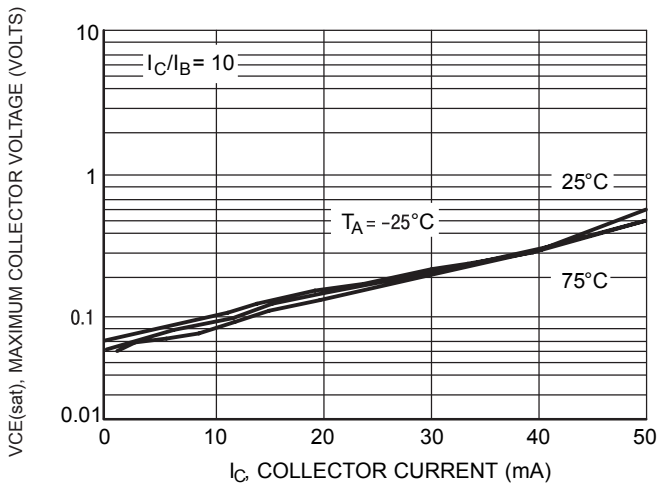

Figure 13.  $V_{CE(sat)}$  versus  $I_C$

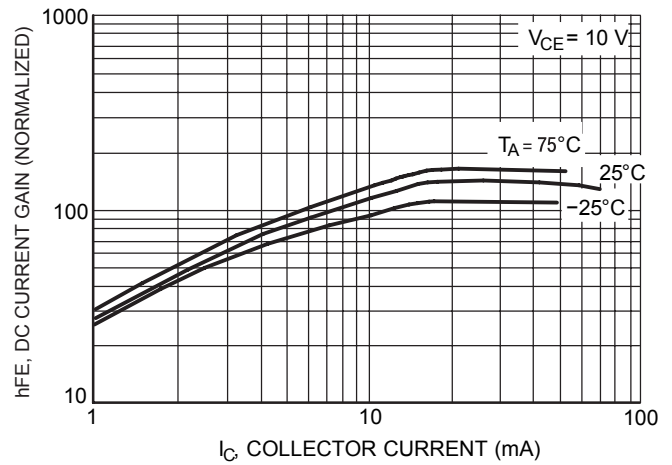

Figure 14. DC Current Gain

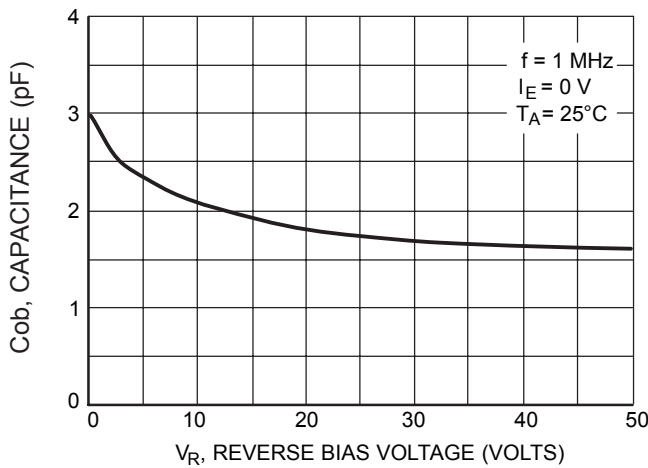

Figure 15. Output Capacitance

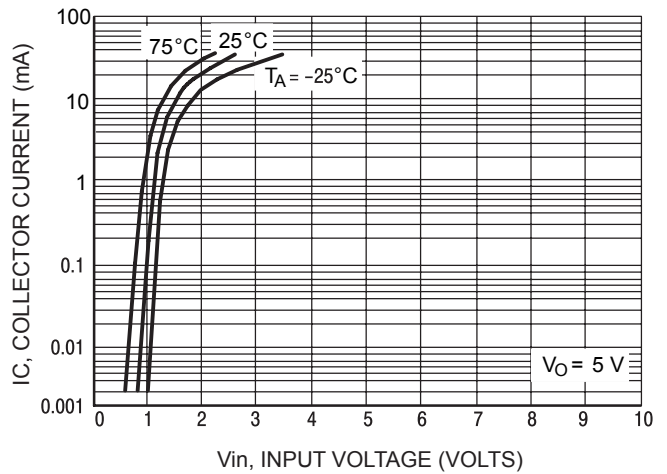

Figure 16. Output Current versus Input Voltage

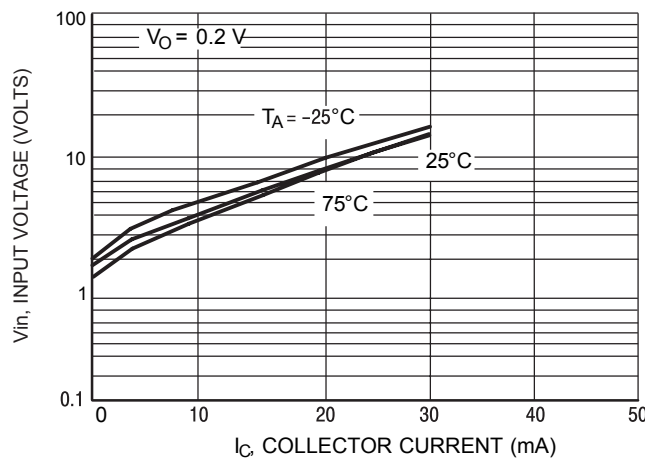

Figure 17. Input Voltage versus Output Current



TYPICAL ELECTRICAL CHARACTERISTICS – DTA144EET1

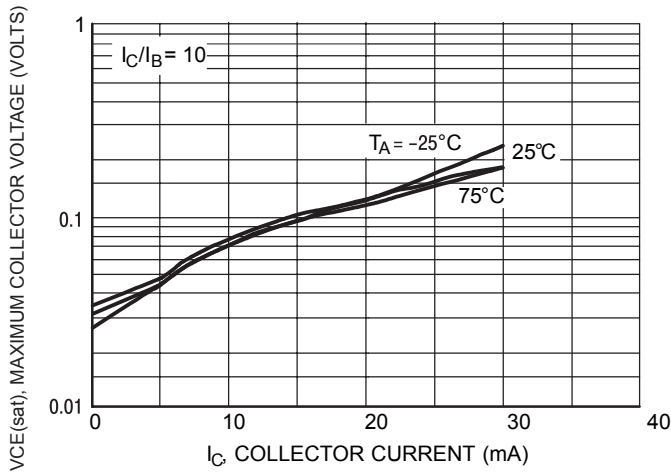

Figure 18.  $V_{CE(sat)}$  versus  $I_C$

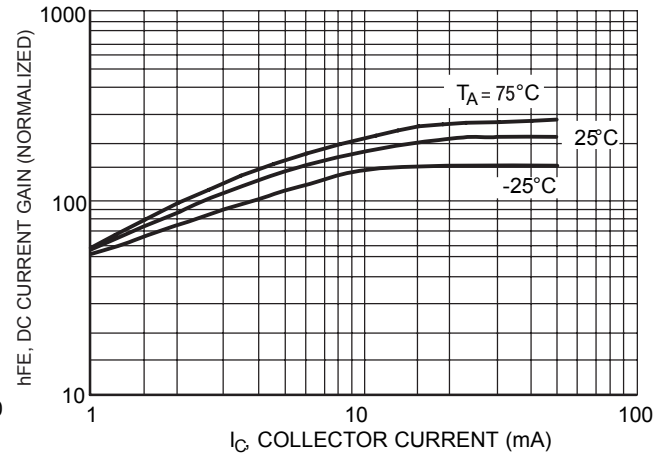

Figure 19. DC Current Gain

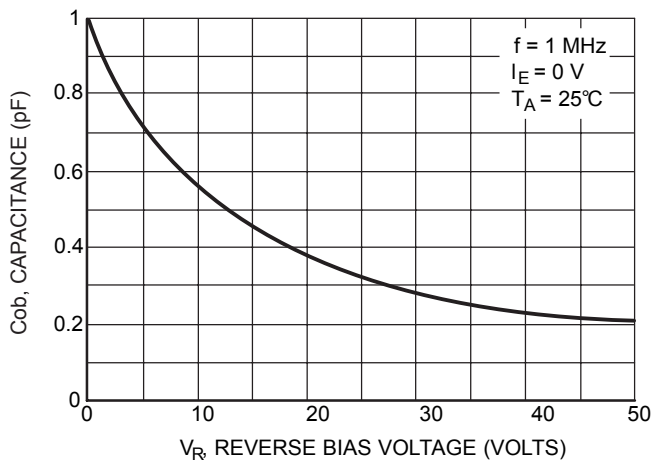

Figure 20. Output Capacitance

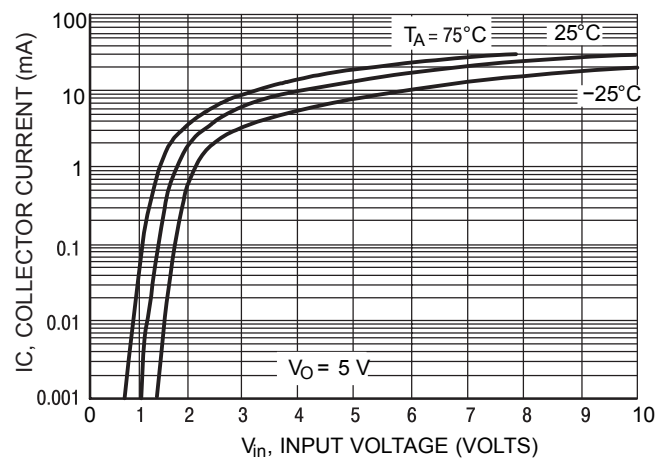

Figure 21. Output Current versus Input Voltage

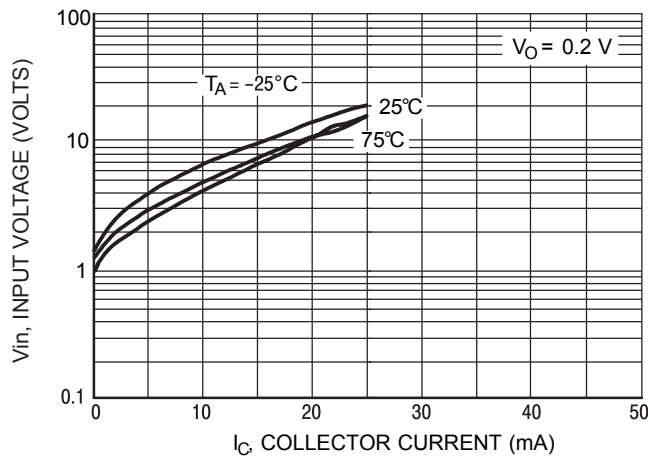
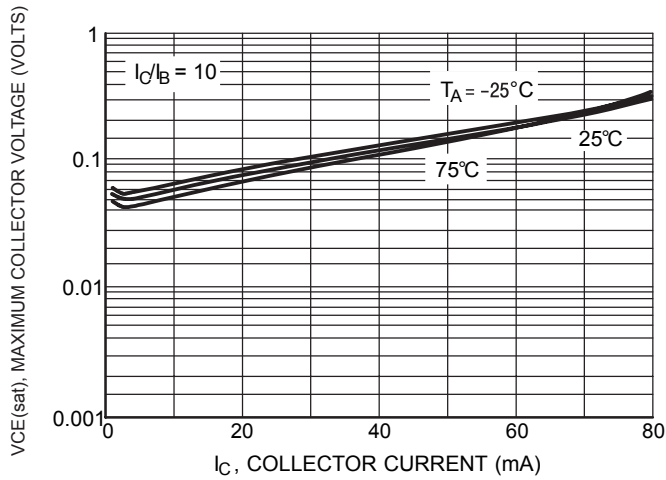
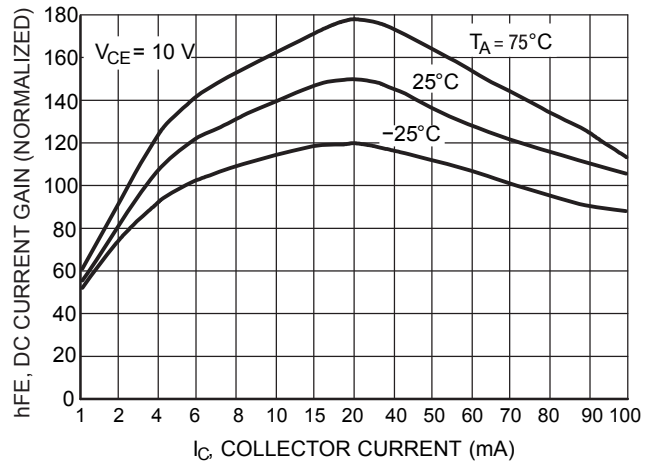

Figure 22. Input Voltage versus Output Current

## TYPICAL ELECTRICAL CHARACTERISTICS – DTA114YET1



**Figure 23.  $V_{CE(sat)}$  versus  $I_C$**



**Figure 24. DC Current Gain**

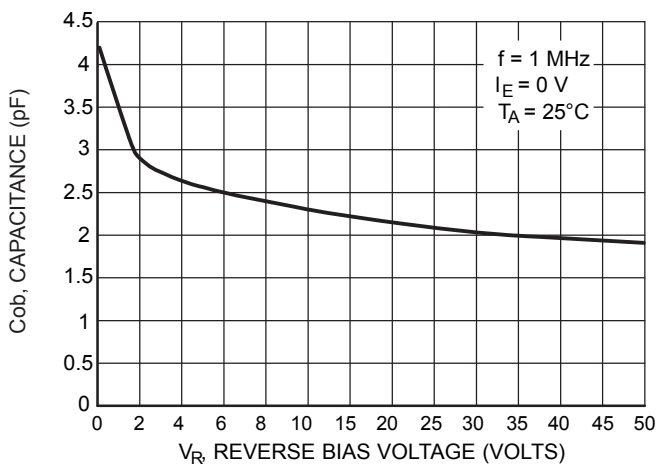

**Figure 25. Output Capacitance**

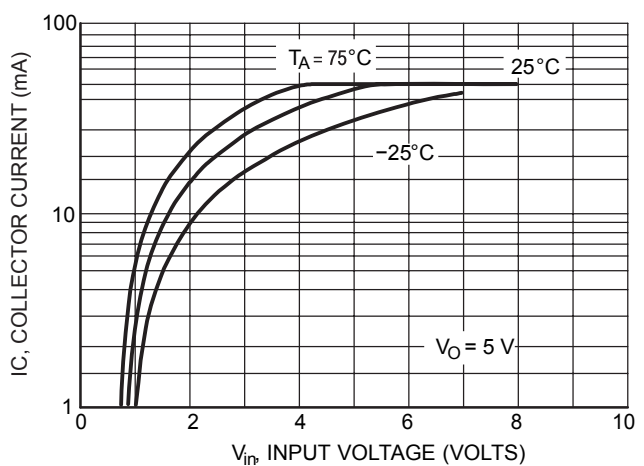

**Figure 26. Output Current versus Input Voltage**

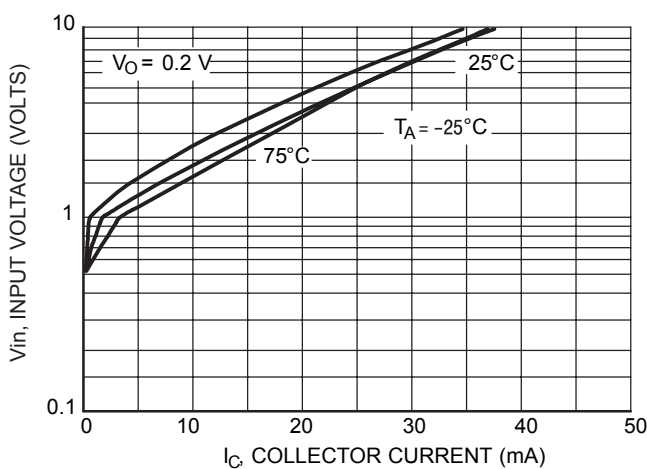

**Figure 27. Input Voltage versus Output Current**

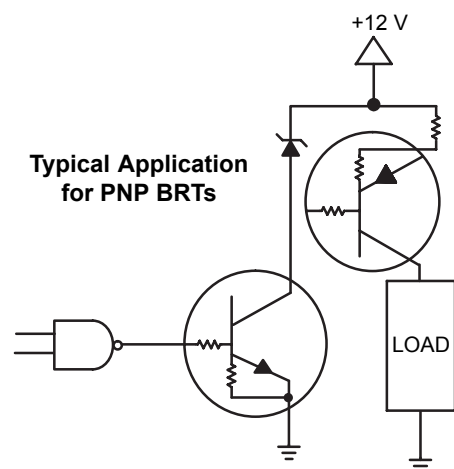

**Figure 28. Inexpensive, Unregulated Current Source**

TYPICAL ELECTRICAL CHARACTERISTICS — DTA115EE1

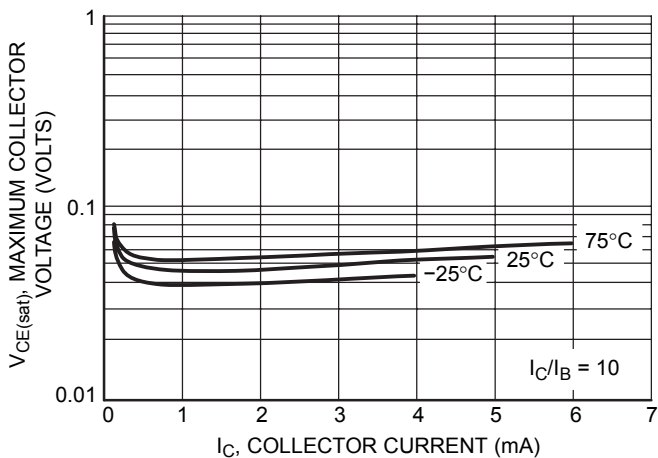

Figure 29. Maximum Collector Voltage versus Collector Current

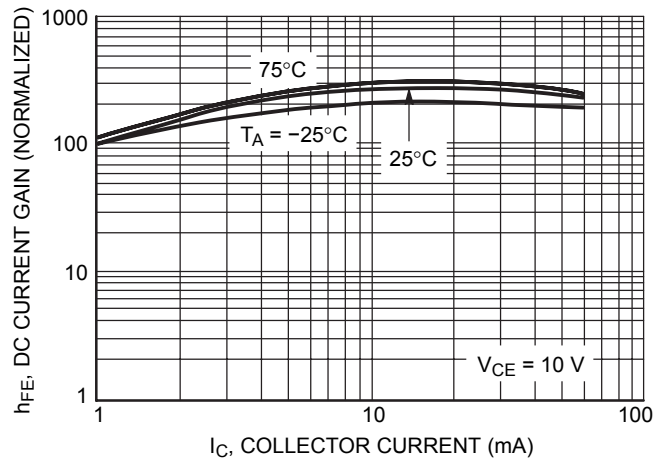

Figure 30. DC Current Gain

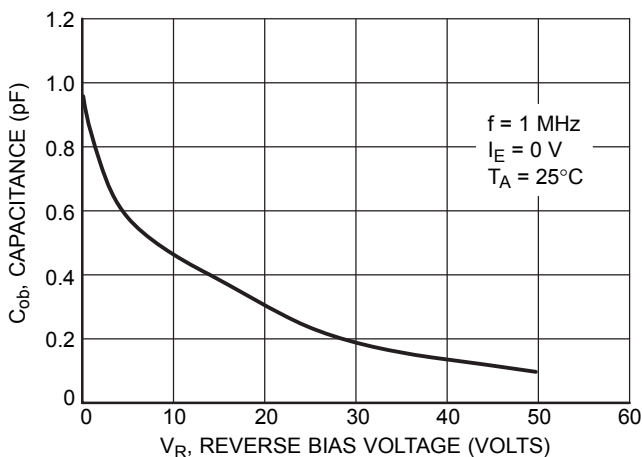

Figure 31. Output Capacitance

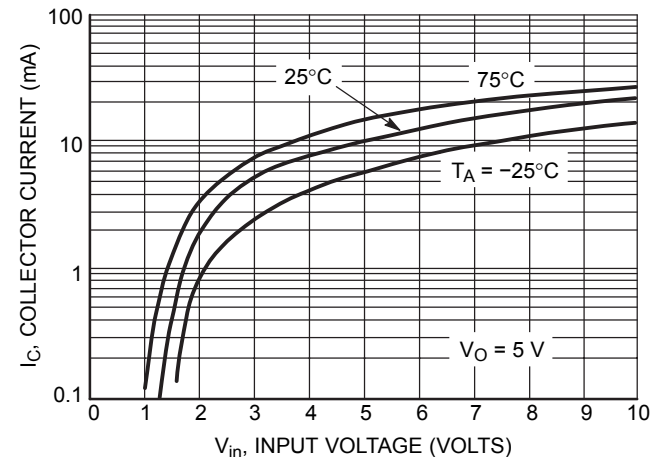

Figure 32. Output Current versus Input Voltage

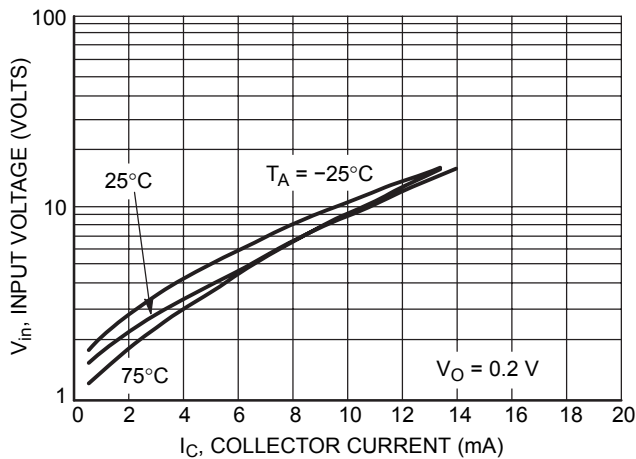

Figure 33. Input Voltage versus Output Current

TYPICAL ELECTRICAL CHARACTERISTICS — DTA144WET1

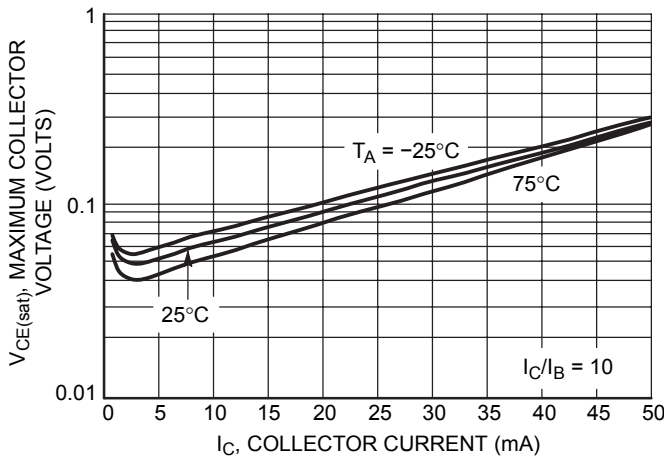

Figure 34. Maximum Collector Voltage versus Collector Current

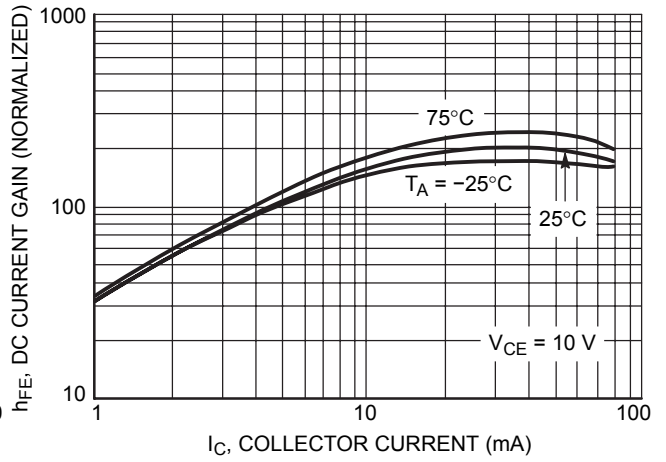

Figure 35. DC Current Gain

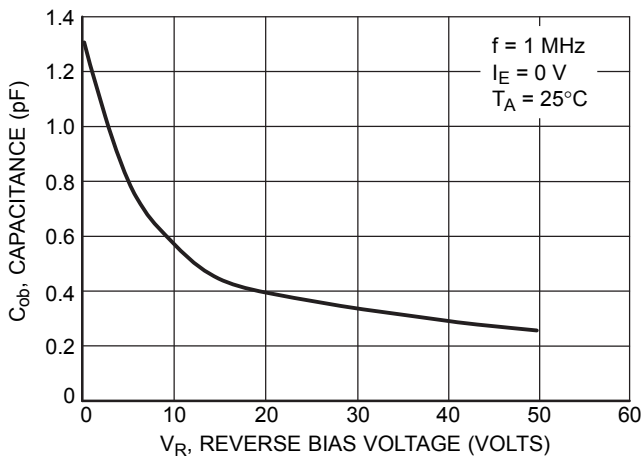

Figure 36. Output Capacitance

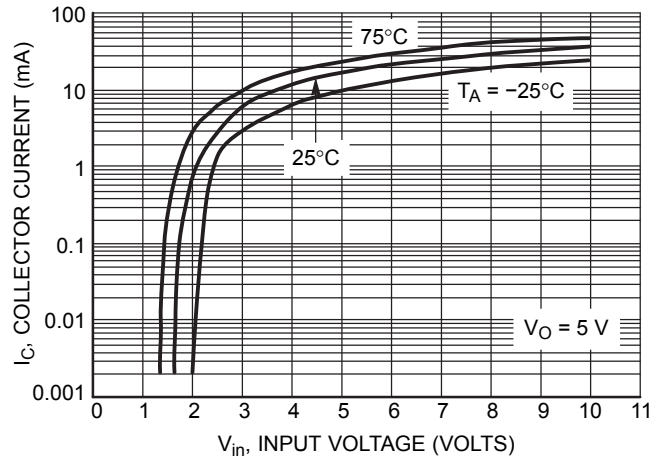

Figure 37. Output Current versus Input Voltage

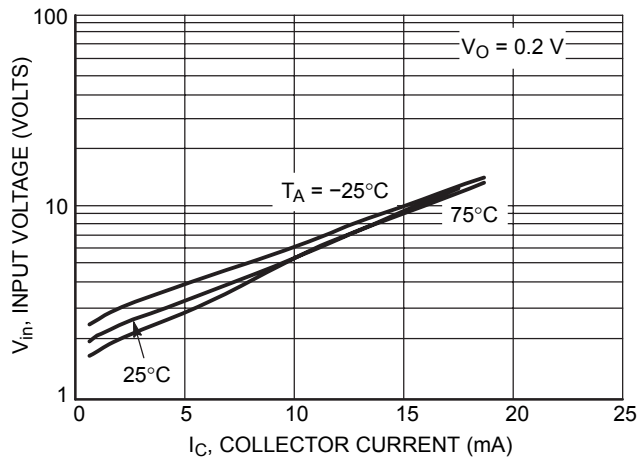
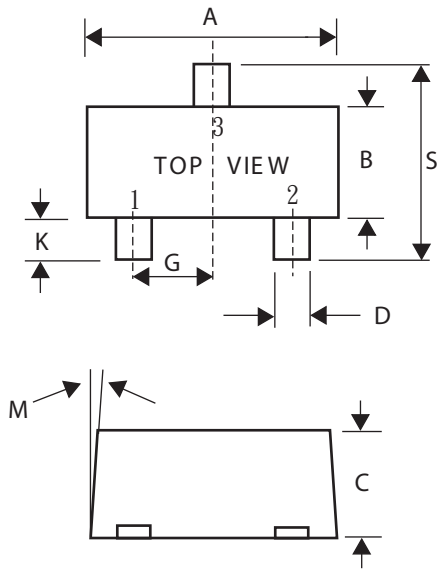

Figure 38. Input Voltage versus Output Current

**SC-89 Outline Demensions**

Unit:mm



SC-89			
Dim	Min	Nom	Max
A	1.50	1.60	1.70
B	0.75	0.85	0.95
C	0.60	0.70	0.80
D	0.23	0.28	0.33
G	0.50BSC		
J	0.10	0.15	0.20
K	0.30	0.40	0.50
M	---	---	10°
N	---	---	10°
S	1.50	1.60	1.70