



ECP100D

1 Watt, High Linearity InGaP HBT Amplifier

The Communications Edge™

Product Information

Product Features

- 400 – 2300 MHz
- +31.5 dBm P1dB
- +46 dBm Output IP3
- 18 dB Gain @ 900 MHz
- 12 dB Gain @ 1960 MHz
- Single Positive Supply (+5V)
- Lead-free/Green/RoHS-compliant 16pin 4mm QFN package

Applications

- Final stage amplifiers for Repeaters
- Mobile Infrastructure
- Defense / Homeland Security

Product Description

The ECP100D is a high dynamic range driver amplifier in a low-cost surface mount package. The InGaP/GaAs HBT is able to achieve superior performance for various narrowband-tuned application circuits with up to +46 dBm OIP3 and +31.5 dBm of compressed 1-dB power. It is housed in an industry standard Lead-free/Green/RoHS-compliant 16-pin 4x4mm QFN SMT package. All devices are 100% RF and DC tested.

The product is targeted for use as driver amplifier for various current and next generation wireless technologies such as GPRS, GSM, CDMA, W-CDMA, and UMTS, where high linearity and high power is required. The internal active bias allows the ECP100D to maintain high linearity over temperature and operate directly off a +5 V supply.

Functional Diagram

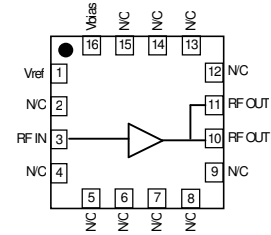

Function	Pin No.
Vref	1
RF Input	3
RF Output	10, 11
Vbias	16
GND	Backside Paddle
N/C or GND	2, 4-9, 12-15

Specifications ⁽¹⁾

Parameter	Units	Min	Typ	Max
Operational Bandwidth	MHz	400		2300
Test Frequency	MHz		2140	
Gain	dB	10	11	
Input Return Loss	dB		18	
Output Return Loss	dB		8	
Output P1dB	dBm	+29	+31.5	
Output IP3 ⁽²⁾	dBm	+43.8	+45	
IS-95 Channel Power @ -45 dBc ACPR, 1960MHz	dBm		+25.5	
W-CDMA Channel Power @ -45 dBc ACPR, 2140 MHz	dBm		+23	
Noise Figure	dB		6.3	
Operating Current Range , Icc ⁽³⁾	mA	400	450	500
Device Voltage, Vcc	V		5	

1. Test conditions unless otherwise noted: T = 25 °C, Vsupply = +5 V in a tuned application circuit.
2. 3OIP measured with two tones at an output power of +15 dBm/tone separated by 1 MHz. The suppression on the largest IM3 product is used to calculate the 3OIP using a 2:1 rule.
3. This corresponds to the quiescent current or operating current under small-signal conditions into pins 10, 11 and 16. It is expected that the current can increase by an additional 90 mA at P1dB. Pin 1 is used as a reference voltage for the internal biasing circuitry. It is expected that Pin 1 will pull 10.8 mA of current when used with a series bias resistor of R1=51 Ω. (ie. total device current typically will be 461 mA.)

Absolute Maximum Rating

Parameter	Rating
Operating Case Temperature	-40 to +85 °C
Storage Temperature	-65 to +125 °C
RF Input Power (continuous)	+26 dBm
Device Voltage	+8 V
Device Current	900 mA
Device Power	5 W
Junction Temperature	+250 °C

Operation of this device above any of these parameters may cause permanent damage.

Typical Performance ⁽⁴⁾

Parameter	Units	Typical		
Frequency	MHz	900	1960	2140
S21 – Gain	dB	18	12	11
S11	dB	-13	-11	-18
S22	dB	-7	-10	-8
Output P1dB	dBm	+31	+32	+31.5
Output IP3	dBm	+46	+46	+45
IS-95A Channel Power @ -45 dBc ACPR	dBm	+25.5	+25.5	
W-CDMA Channel Power @ -45 dBc ACPR	dBm			+23
Noise Figure	dB	7.0	5.5	6.2
Supply Bias ⁽³⁾		+5 V @ 450 mA		

4. Typical parameters reflect performance in a tuned application circuit at +25 °C.

Ordering Information

Part No.	Description
ECP100D-G	1 Watt InGaP HBT Amplifier (Lead-free/Green/RoHS-compliant 16-pin 4x4mm Pkg.)
ECP100D-PCB900	900 MHz Evaluation Board
ECP100D-PCB1960	1960 MHz Evaluation Board
ECP100D-PCB2140	2140 MHz Evaluation Board

Specifications and information are subject to change without notice



ECP100D

1 Watt, High Linearity InGaP HBT Amplifier

The Communications Edge™

Product Information

Typical Device Data – ECP100D (QFN 4x4mm Package)

S-Parameters ($V_{cc} = +5\text{ V}$, $I_{cc} = 450\text{ mA}$, $T = 25\text{ }^\circ\text{C}$, calibrated to device leads)

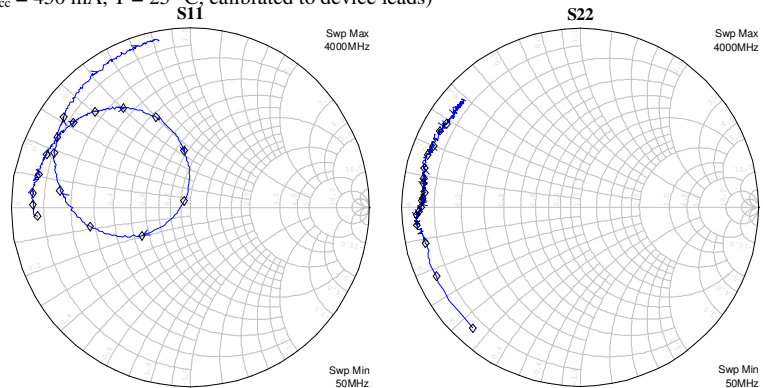
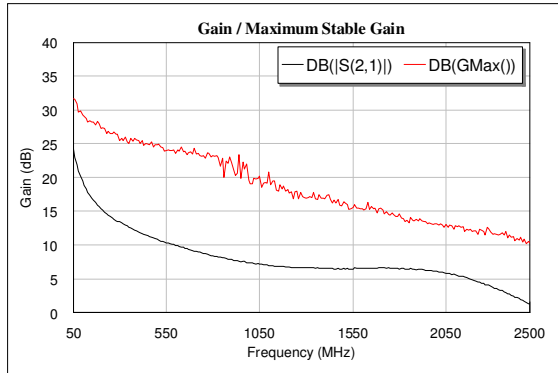

Notes:

The gain for the unmatched device in 50 ohm system is shown as the trace in black color. For a tuned circuit for a particular frequency, it is expected that actual gain will be higher, up to the maximum stable gain. The maximum stable gain is shown in the dashed red line. The impedance loss plots are shown from 0.05, 0.1 and 0.2 – 4.0 GHz, with markers placed in 0.2 GHz increments.

S-Parameters ($V_{cc} = +5\text{ V}$, $I_{cc} = 450\text{ mA}$, $T = 25\text{ }^\circ\text{C}$, unmatched 50 ohm system, calibrated to device leads)

Freq (MHz)	S11 (dB)	S11 (ang)	S21 (dB)	S21 (ang)	S12 (dB)	S12 (ang)	S22 (dB)	S22 (ang)
50	-1.35	-176.77	24.16	120.86	-39.11	18.98	-0.87	-131.71
100	-1.11	179.08	19.50	115.85	-38.95	8.44	-1.00	-154.54
200	-1.09	174.88	15.39	113.56	-39.17	8.30	-1.02	-167.00
400	-1.24	167.79	11.91	103.30	-39.00	-4.09	-0.72	-173.95
600	-1.36	159.88	9.93	92.23	-37.15	-12.20	-0.75	-177.40
800	-1.51	152.29	8.39	81.19	-38.07	-10.64	-0.87	-178.56
1000	-1.88	144.07	7.37	70.82	-38.22	-7.28	-1.00	179.90
1200	-2.45	135.03	6.77	59.35	-36.33	-22.70	-1.02	177.51
1400	-3.52	124.13	6.49	45.92	-35.42	-38.76	-1.07	176.63
1600	-5.37	110.92	6.54	30.31	-34.81	-55.67	-1.15	174.49
1800	-9.94	96.35	6.46	9.32	-33.63	-73.80	-1.01	171.25
2000	-26.16	134.17	6.08	-13.70	-33.50	-93.59	-1.00	169.44
2200	-10.08	-149.55	4.75	-39.92	-35.80	-116.52	-0.92	165.85
2400	-4.89	-169.19	2.58	-63.31	-36.84	-156.32	-0.88	161.06
2600	-2.68	172.75	0.02	-82.87	-37.99	-159.31	-1.01	157.31
2800	-1.73	158.17	-2.72	-98.11	-40.80	148.39	-0.96	151.44
3000	-1.22	144.56	-5.32	-111.57	-43.97	152.56	-1.08	148.03

Application Circuit PC Board Layout

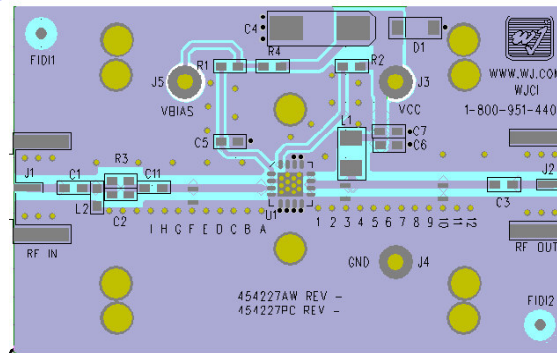

Circuit Board Material: Top RF layer is .014" Getek, 4 total layers (0.062" thick) for mechanical rigidity
1 oz copper, Microstrip line details: width = .026", spacing = .026"
The silk screen markers 'A', 'B', 'C', etc. and '1', '2', '3', etc. are used as placemarkers for the input and output tuning shunt capacitors – C8, C9 and C10. The markers and vias are spaced in .050" increments.

Specifications and information are subject to change without notice



ECP100D

1 Watt, High Linearity InGaP HBT Amplifier

The Communications Edge™

Product Information

900 MHz Application Circuit (ECP100D-PCB900)

Typical RF Performance at 25 °C

Frequency	900 MHz
S21 – Gain	18 dB
S11 – Input Return Loss	-13 dB
S22 – Output Return Loss	-7.0 dB
Output P1dB	+31 dBm
Output IP3 (+15 dBm / tone, 1 MHz spacing)	+46 dBm
Channel Power (@-45 dBc ACPR, IS-95 9 channels fwd)	+25.5 dBm
Noise Figure	7.0 dB
Device / Supply Voltage	+5 V
Quiescent Current ⁽¹⁾	450 mA

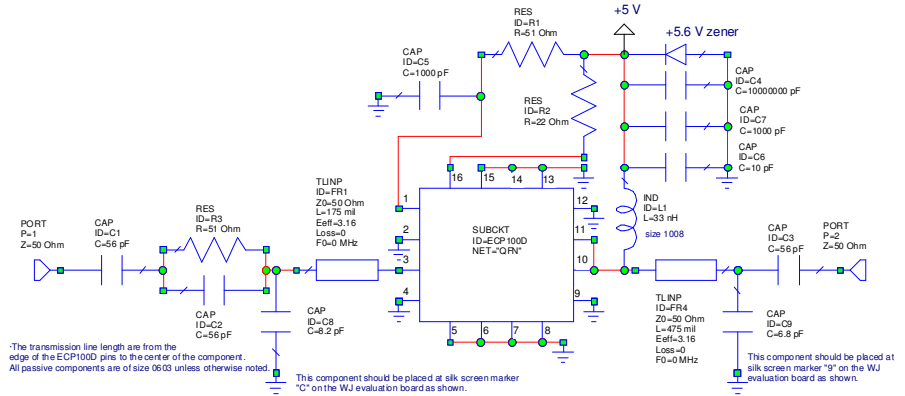

1. This corresponds to the quiescent current or operating current under small-signal conditions into pins 6, 7, and 8.

S21 vs. Frequency (MHz)

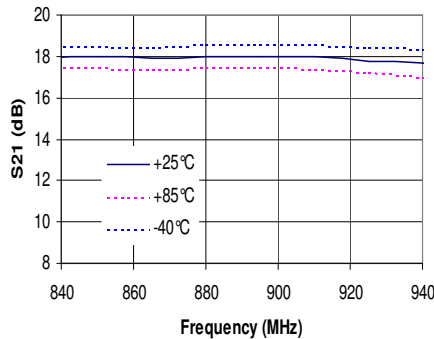

S11 vs. Frequency

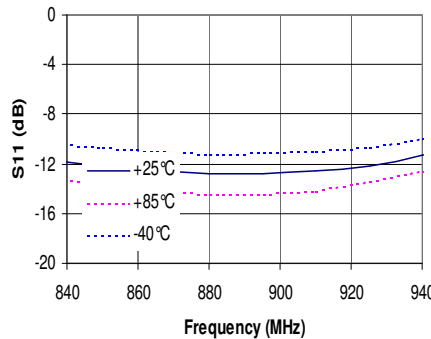

S22 vs. Frequency

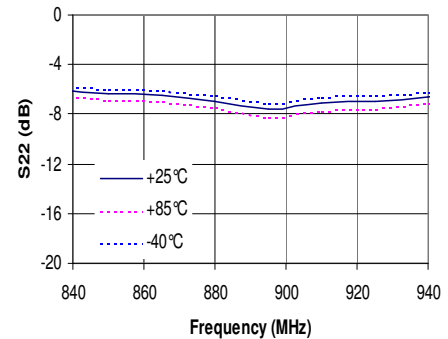

Noise Figure vs. Frequency

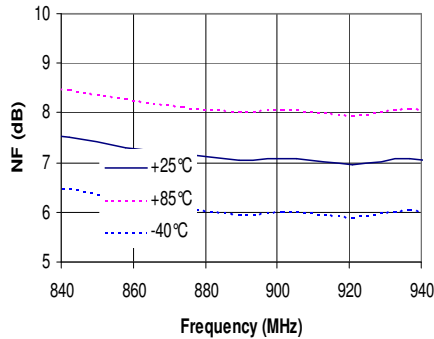

P1 dB vs. Frequency

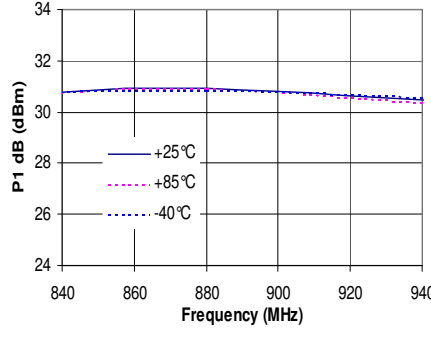

ACPR vs. Channel Power

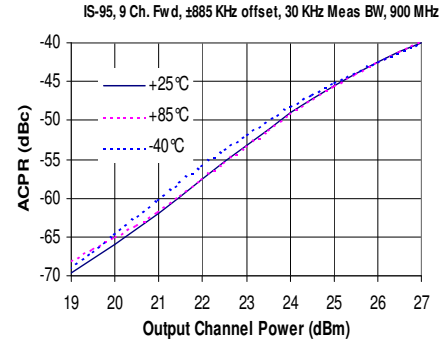

OIP3 vs. Output Power

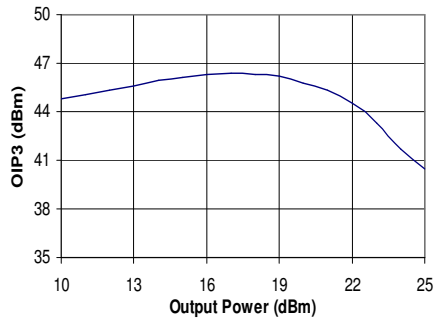

OIP3 vs. Temperature

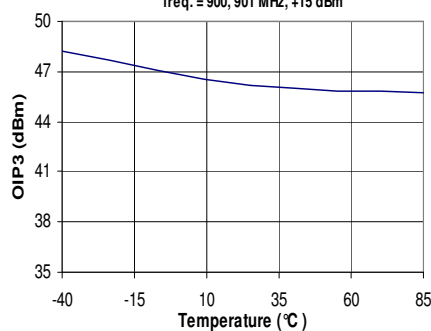

OIP3 vs. Frequency

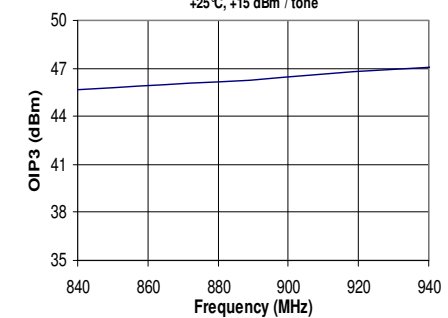

Specifications and information are subject to change without notice



ECP100D

1 Watt, High Linearity InGaP HBT Amplifier

The Communications Edge™

Product Information

1960 MHz Application Circuit (ECP100D-PCB1960)

Typical RF Performance at 25 °C

Frequency	1960 MHz
S21 – Gain	12 dB
S11 – Input Return Loss	-11 dB
S22 – Output Return Loss	-10 dB
Output P1dB	+32 dBm
Output IP3 (+17 dBm / tone, 1 MHz spacing)	+46 dBm
Channel Power (@-45 dBc ACPR, IS-95 9 channels fwd)	+25.5 dBm
Noise Figure	5.5 dB
Device / Supply Voltage	+5 V
Quiescent Current ⁽¹⁾	450 mA

1. This corresponds to the quiescent current or operating current under small-signal conditions into pins 6, 7, and 8.

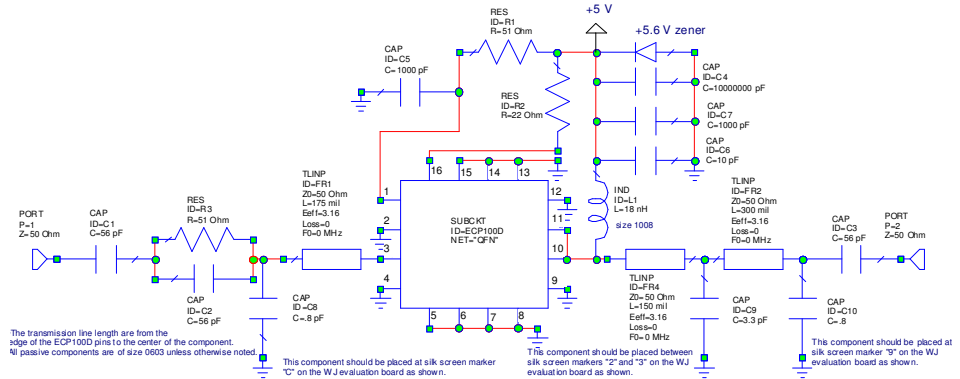

S21 vs. Frequency

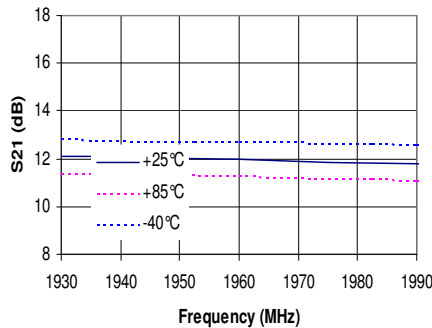

S11 vs. Frequency

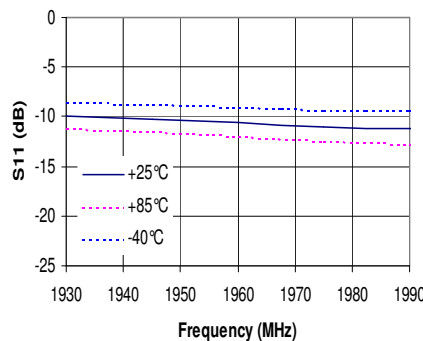

S22 vs. Frequency

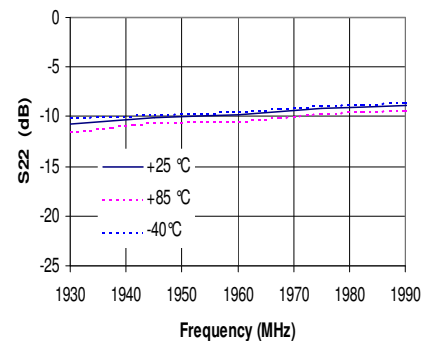

Noise Figure vs. Frequency

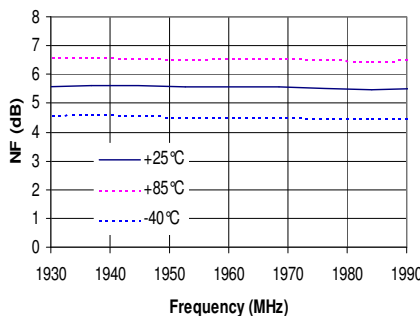

P1 dB vs. Frequency

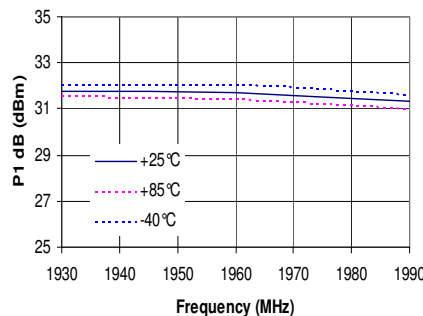

ACPR vs. Channel Power

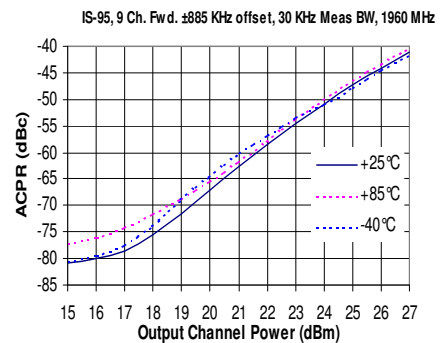

OIP3 vs. Frequency

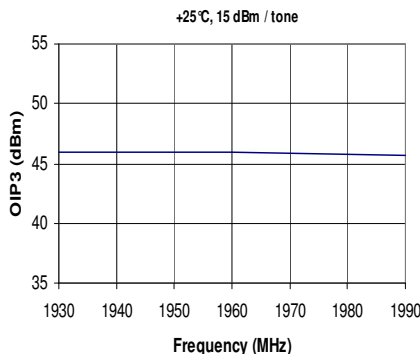

OIP3 vs. Temperature

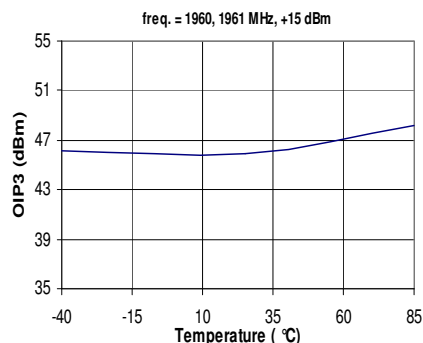

OIP3 vs. Output Power

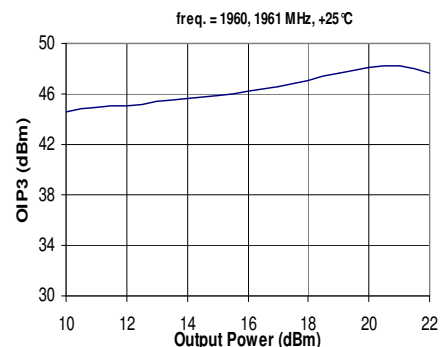

Specifications and information are subject to change without notice



2140 MHz Application Circuit (ECP100D-PCB2140)

Typical RF Performance at 25 °C

Frequency	2140 MHz
S21 – Gain	11 dB
S11 – Input Return Loss	-18 dB
S22 – Output Return Loss	-8.0 dB
Output P1 dB	+31.5 dBm
Output IP3 (+15 dBm / tone, 1 MHz spacing)	+45 dBm
Channel Power (@-45 dBc ACPR, IS-95 9 channels fwd)	+23 dBm
Noise Figure	6.2 dB
Device / Supply Voltage	+5 V
Quiescent Current ⁽¹⁾	450 mA

1. This corresponds to the quiescent current or operating current under small-signal conditions into pins 6, 7, and 8.

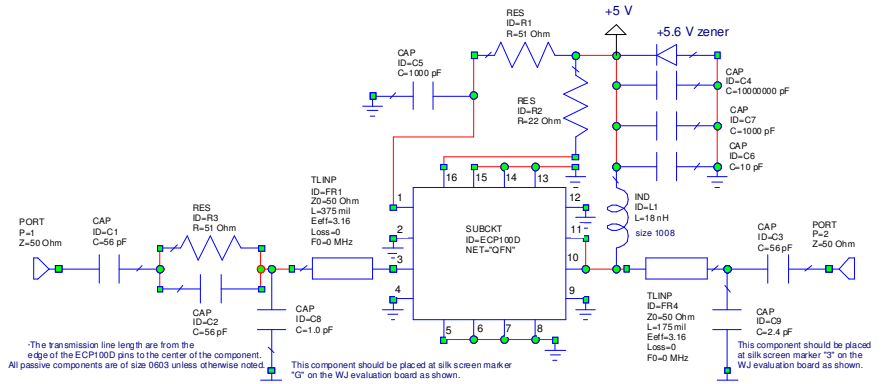

*The transmission line length are from the edge of the ECP100D pins to the center of the component.
All passive components are of size 0603 unless otherwise noted.

This component should be placed at silk screen marker "Q" on the WJ evaluation board as shown.

This component should be placed at silk screen marker "3" on the WJ evaluation board as shown.

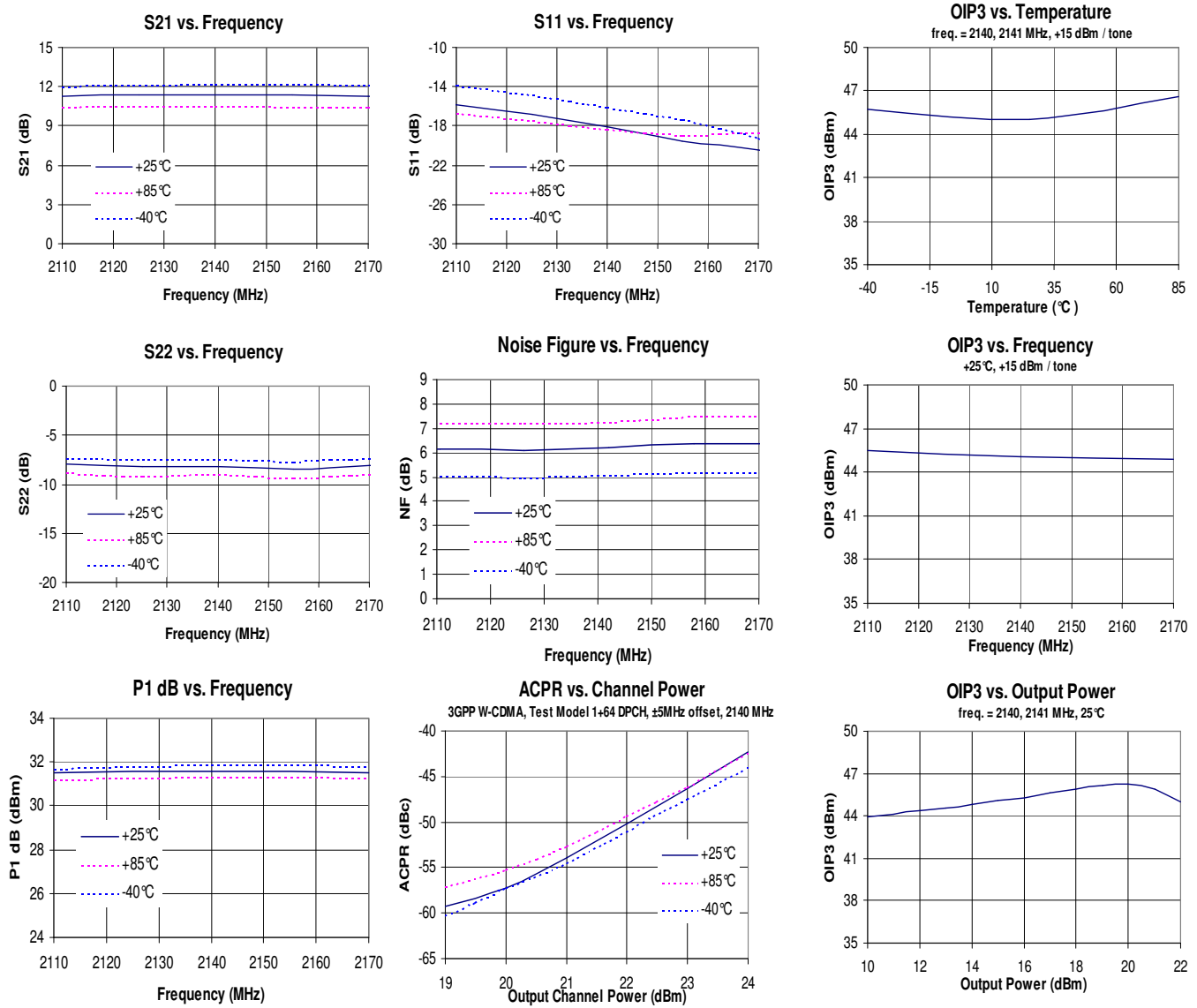

Specifications and information are subject to change without notice



Application Note: Reduced Bias Configurations

The ECP100D, like the AH215-S8 can be configured to operate with lower bias current by varying the bias-adjust resistor – R1. The recommended circuit configurations shown previously in this datasheet have the device operating in Class A operation. Lowering the current has little effect on the gain, OIP3, and P1dB performance of the device, but will slightly lower the ACLR/ACPR performance of the device as shown below. An example of the measured data below represents the AH215-S8 measured and configured for 2.14 GHz applications. It is expected that variation of the bias current for other frequency applications will produce similar performance results.

AH215S8-PCB2140 Performance Data

R1 (ohms)	Icq (mA)	Pdiss (W)	P1dB (dBm)	OIP3 (dBm)
51	450	2.25	+31.0	+47.1
68	400	2.00	+30.9	+46.4
100	350	1.75	+30.8	+46.4
130	300	1.50	+30.6	+45.5
180	250	1.25	+30.5	+43.6

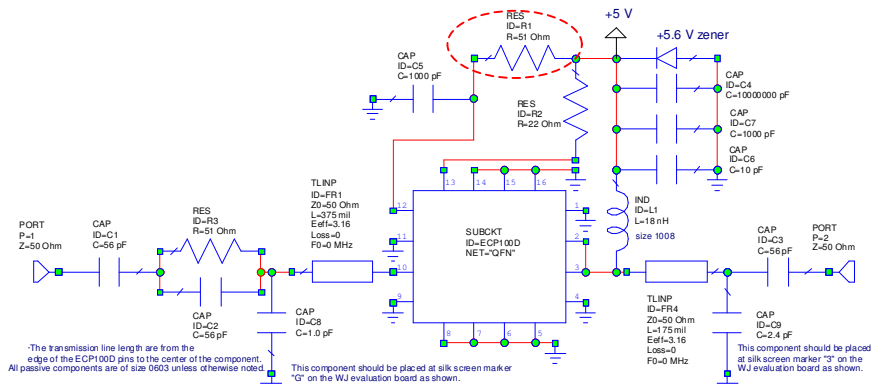

2.14GHz Gain vs. Output Power

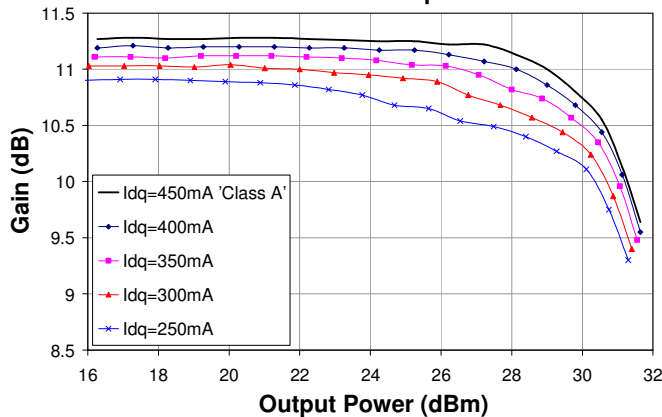

2.14GHz OIP3 vs. Output Power per Tone

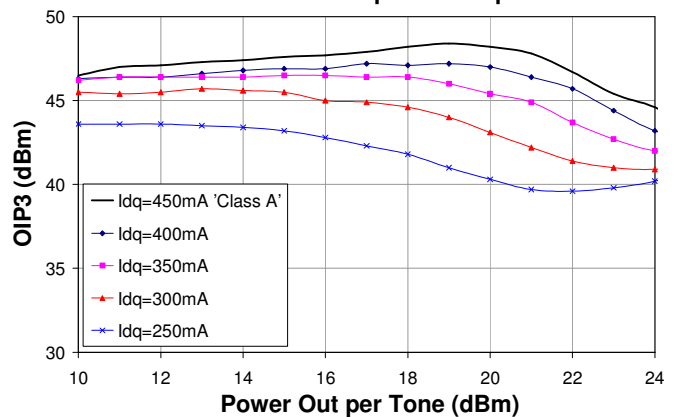

W-CDMA ACLR vs. Output Channel Power

3GPP W-CDMA, Test Model 1 + 64 DPCH, ±5 MHz offset

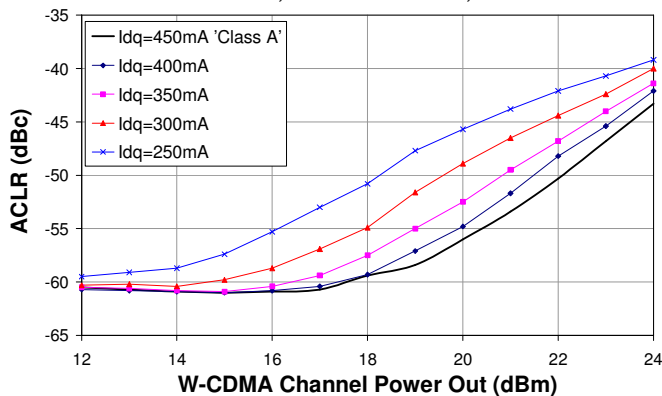

CW PAE vs. Output Power

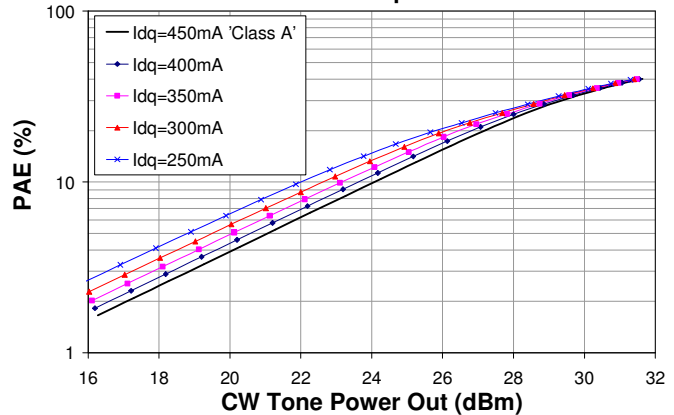



ECP100D

1 Watt, High Linearity InGaP HBT Amplifier

The Communications Edge™

Product Information

ECP100D-G Mechanical Information

This package is Lead-free/Green/RoHS-compliant. It is compatible with both lead-free (maximum 260 °C reflow temperature) and leaded (maximum 245 °C reflow temperature) soldering processes. The plating material on the pins is annealed matte tin over copper.

Outline Drawing

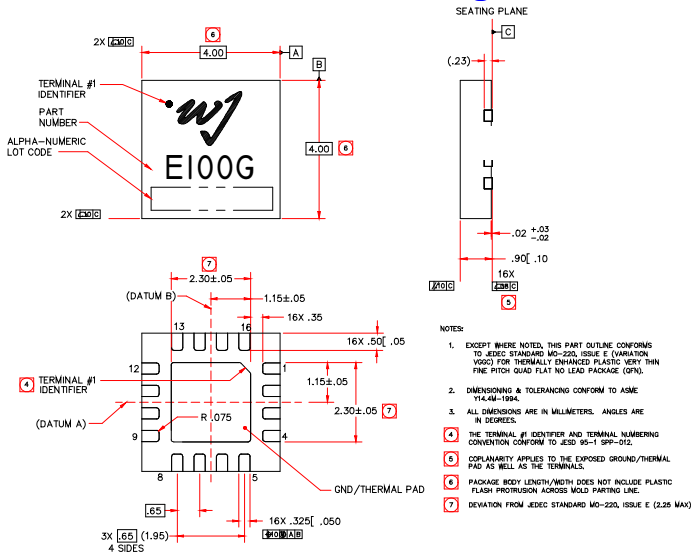

Land Pattern

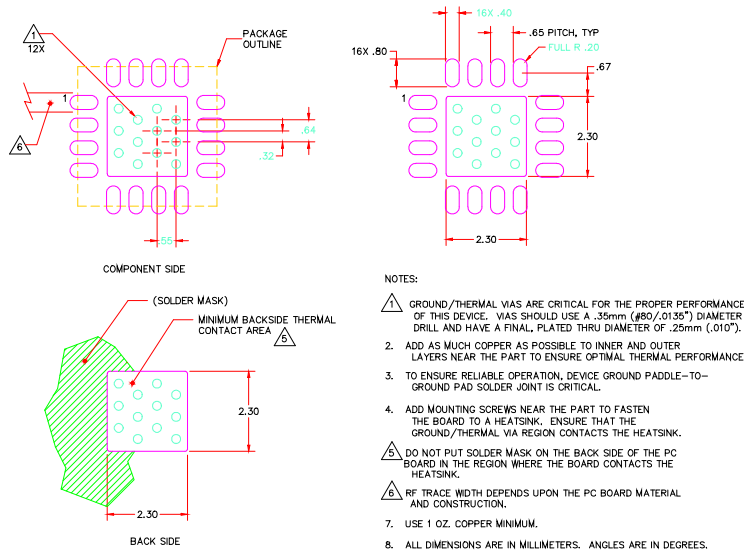

Thermal Specifications

Parameter	Rating
Operating Case Temperature	-40 to +85 °C
Thermal Resistance, Rth ⁽¹⁾	33 °C / W
Junction Temperature, Tj ⁽²⁾	159 °C

Notes:

- The thermal resistance is referenced from the junction-to-case at a case temperature of 85 °C. Tjc is a function of the voltage at pins 10 and 11 and the current applied to pins 10, 11, and 16 and can be calculated by:
 $T_j = T_{case} + R_{th} * V_{cc} * I_{cc}$
- This corresponds to the typical biasing condition of +5V, 450 mA at an 85 °C case temperature. A minimum MTTF of 1 million hours is achieved for junction temperatures below 247 °C.

MTTF vs. GND Tab Temperature

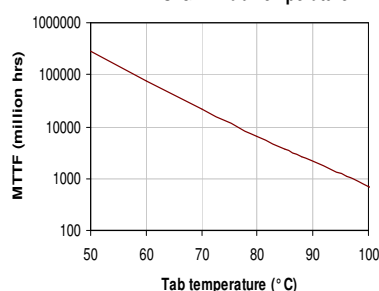

Product Marking

The component will be marked with an "E100G" designator with an alphanumeric lot code on the top surface of the package. The obsolete tin-lead package is marked with an "EC100D" designator followed by an alphanumeric lot code.

Tape and reel specifications for this part are located on the website in the "Application Notes" section.

ESD / MSL Information



Caution! ESD sensitive device.

ESD Rating: Class 1B
 Value: Passes between 500 and 1000V
 Test: Human Body Model (HBM)
 Standard: JEDEC Standard JESD22-A114

MSL Rating: Level 2 at +260 °C convection reflow
 Standard: JEDEC Standard J-STD-020

Mounting Config. Notes

- A heatsink underneath the area of the PCB for the mounted device is recommended for proper thermal operation. Damage to the device can occur without the use of one.
- Ground / thermal vias are critical for the proper performance of this device. Vias should use a .35mm (#80 / .0135") diameter drill and have a final plated thru diameter of .25 mm (.010").
- Add as much copper as possible to inner and outer layers near the part to ensure optimal thermal performance.
- Mounting screws can be added near the part to fasten the board to a heatsink. Ensure that the ground / thermal via region contacts the heatsink.
- Do not put solder mask on the backside of the PC board in the region where the board contacts the heatsink.
- RF trace width depends upon the PC board material and construction.
- Use 1 oz. Copper minimum.
- All dimensions are in millimeters (inches). Angles are in degrees.