

**GLASS PASSIVATED SUPER FAST
SILICON SURFACE MOUNT BRIDGE RECTIFIER**
VOLTAGE RANGE 50 to 400 Volts CURRENT 1.0 Ampere

FEATURES

- * Good for automatic insertion
- * Surge overloading rating - 50 amperes peak
- * Ideal for printed circuit board
- * Reliable low cost construction utilizing molded
- * Glass passivated device
- * Polarity symbols molded on body
- * Mounting position: Any
- * Weight: 1.0 gram

MECHANICAL DATA

- * UL listed the recognized component directory, file #94233
- * Epoxy: Device has UL flammability classification 94V-0

MAXIMUM RATINGS AND ELECTRICAL CHARACTERISTICS

Ratings at 25 °C ambient temperature unless otherwise specified.
Single phase, half wave, 60 Hz, resistive or inductive load.
For capacitive load, derate current by 20%.

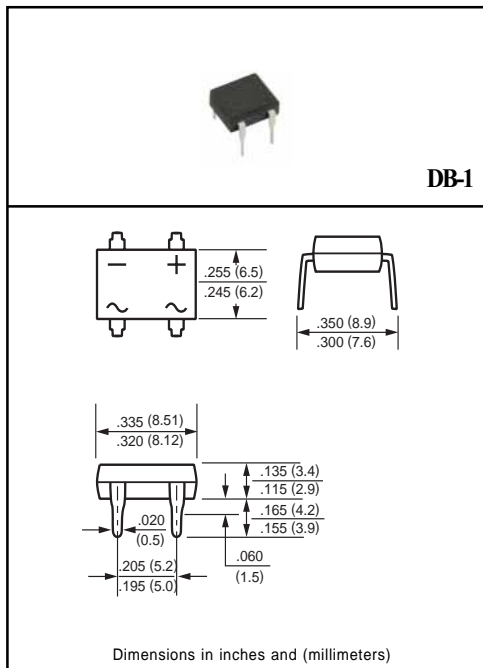

MAXIMUM RATINGS (At TA = 25°C unless otherwise noted)

RATINGS	SYMBOL	EDB101	EDB102	EDB103	EDB104	EDB105	EDB106	UNITS
Maximum Recurrent Peak Reverse Voltage	V _{RRM}	50	100	150	200	300	400	Volts
Maximum RMS Volts	V _{RMS}	35	70	105	140	210	280	Volts
Maximum DC Blocking Voltage	V _{DC}	50	100	150	200	300	400	Volts
Maximum Average Forward Current at TA = 55°C	I _O	1.0						Amps
Peak Forward Surge Current I _{FM} (surge):8.3 ms single half sine-wave superimposed on rated load (JEDEC method)	I _{FSM}	30						Amps
Typical Junction Capacitance (Note 2)	C _J	15				10		pF
Operating and Storage Temperature Range	T _J , T _{STG}	-65 to + 150						°C

ELECTRICAL CHARACTERISTICS (At TA = 25°C unless otherwise noted)

CHARACTERISTICS	SYMBOL	EDB101	EDB102	EDB103	EDB104	EDB105	EDB106	UNITS
Maximum Forward Voltage at 1.0A DC	V _F	1.0				1.25		Volts
Maximum DC Reverse Current	I _R	5.0				50		uAmps
at Rated DC Blocking Voltage								
Maximum Reverse Recovery Time (Note 1)	t _{rr}	50						nSec

NOTES : 1. Test Conditions: I_F=0.5A, I_R=-1.0A, I_{RR}=-0.25A.
2. Measured at 1 MHz and applied reverse voltage of 4.0 volts.

RATING AND CHARACTERISTIC CURVES (EDB101 THRU EDB106)

FIG. 1 - TEST CIRCUIT DIAGRAM AND REVERSE RECOVERY TIME CHARACTERISTIC

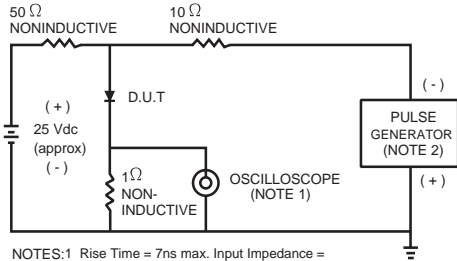

NOTES: 1. Rise Time = 7ns max. Input Impedance = 1 megohm, 22pF.
2. Rise Time = 10ns max. Source Impedance = 50 ohms.

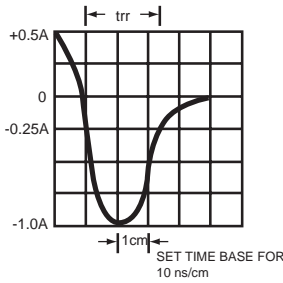

FIG. 2 - TYPICAL FORWARD CURRENT DERATING CURVE

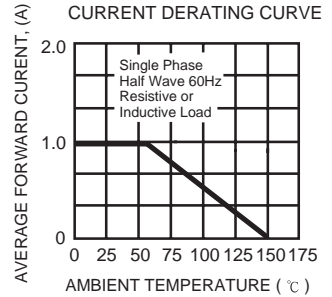

FIG. 3 - TYPICAL REVERSE CHARACTERISTICS

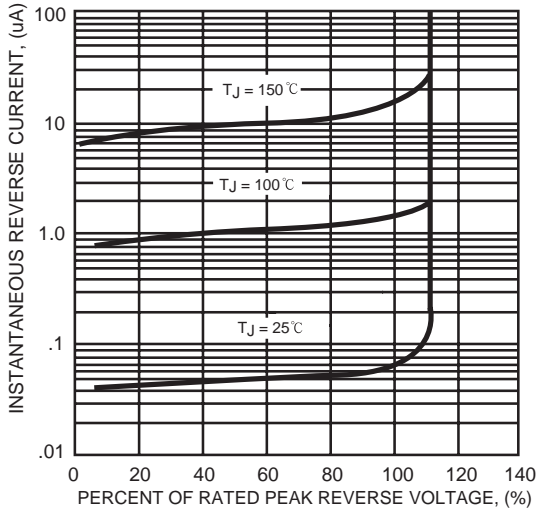

FIG. 4 - TYPICAL INSTANTANEOUS FORWARD CHARACTERISTICS

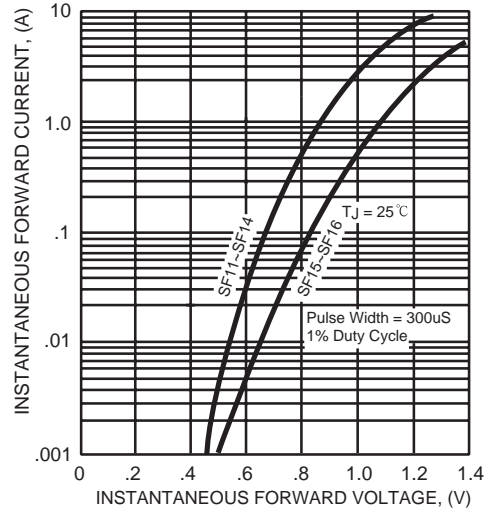

FIG. 5 - MAXIMUM NON-REPETITIVE FORWARD SURGE CURRENT

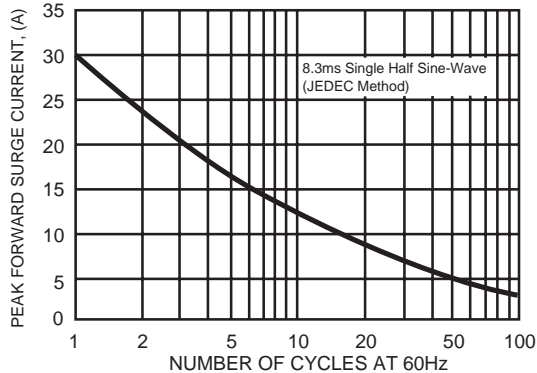

FIG. 6 - TYPICAL JUNCTION CAPACITANCE

