

EE-SB5M/SB5MC/SB5V/SB5VC/SB5V-E

Photomicrosensor with 80-mA
Switching Capacity that can be Built
into Equipment

- Built-in amplifier
- Models available with 5- to 12-VDC and 5- to 15-VDC input
- CMOS- and TTL-compatible
- Model with easy adjustment with an external sensitivity adjuster (EE-SB5V)
- Special connectors (EE-1001/1006) are available
- 19-mm sensing distance (EE-SB5V-E)
- Convert to PNP output with EE-2002 conversion connector



Ordering Information

Appearance	Sensing method	Sensing distance	Output configuration	Weight	Part number
	Reflective	5 mm	Light-ON	Approx. 3.0 g	EE-SB5M
			Dark-ON		EE-SB5MC
			Light-ON		EE-SB5V
			Dark-ON		EE-SB5VC
		19 mm	Light-ON	Approx. 2.8 g	EE-SB5V-E

Specifications

RATINGS

Item	Reflective			
	EE-SB5M	EE-SB5MC	EE-SB5V(-E)	EE-SB5VC
Supply voltage	5 to 12 VDC $\pm 10\%$, ripple (p-p): 10% max.		5 to 15 VDC $\pm 10\%$, ripple (p-p): 10% max.	
Current consumption	36 mA max.		48 mA max. (DC current: $I_F = 25$ mA)	
Maximum forward direct current (I_F)	—		30 mA max.	
Forward voltage (V_F)	—		1.5 V max. ($I_F = 30$ mA)	
Reverse voltage (V_R)	—		4 V max.	
Standard reference object	White paper with reflection factor of 90% (standard sensing object: 15 x 15 mm)			
Differential distance	0.1 mm			

(This table continues on the next page.)

Specifications Table - continued from previous page

Item		Reflective			
		EE-SB5M	EE-SB5MC	EE-SB5V(-E)	EE-SB5VC
Control output		At 5 to 24 VDC: 80-mA load current (I_C) with a residual voltage of 0.8 V max. When driving TTL: 40-mA load current (I_C) with a residual voltage of 0.4 V max.			
Output configuration	Transistor on output stage without detecting object	OFF	ON	OFF	ON
	Transistor on output stage with detecting object	ON	OFF	ON	OFF
Response frequency*		50 Hz			
Connecting method		EE-1001/1006 Connectors; soldering terminals			
Light source		GaAs infrared LED with a peak wavelength of 940 nm			
Receiver		Si photo-transistor with a sensing wavelength of 850 nm max.			

*The response frequency was measured by detecting the following disks rotating.

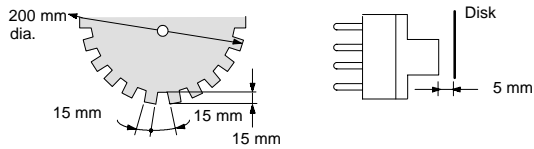

CHARACTERISTICS

Ambient temperature	Operating	-25°C to 55°C (-13°F to 131°F)
	Storage	-30°C to 80°C (-22°F to 176°F)
Ambient humidity	Operating	45% to 85%
	Storage	35% to 95%
Vibration resistance	Destruction: 20 to 2,000 Hz (with a peak acceleration of 20G's), 1.5-mm double amplitude for 4 min each in X, Y, and Z directions	
Shock resistance	Destruction: 500 m/s ² for 3 times each in X, Y, and Z directions	
Soldering heat resistance	260°±5°C (See Note.) when the portion between the tip of the terminals and the position 1.5 mm from the terminal base is dipped into the solder for 10±1 seconds	

Note: This conforms to MIL-STD-750-2031-1.

Engineering Data

■ OPERATING RANGE (TYPICAL 1)

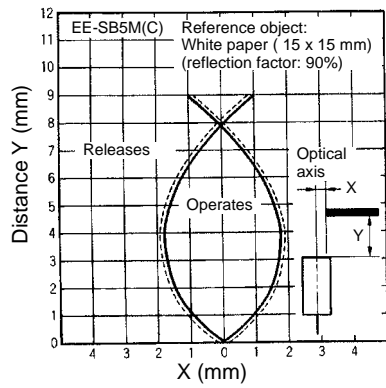

■ OPERATING RANGE (TYPICAL 2)

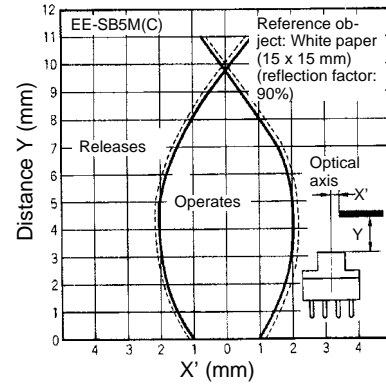

■ SENSING DISTANCE VS. OBJECT AREA (TYPICAL)

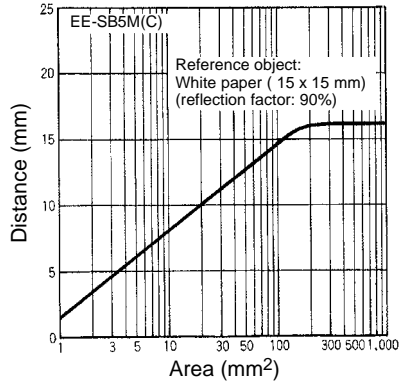

■ SENSING DISTANCE VS. I_F EE-SB5V-E (TYPICAL)

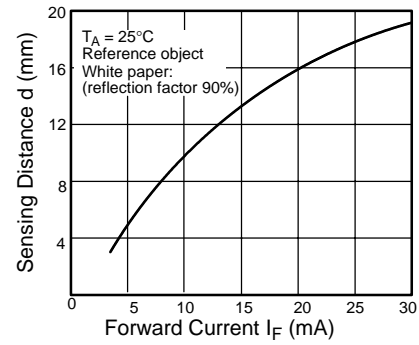

Operation

INTERNAL/EXTERNAL CIRCUIT DIAGRAMS

EE-SB5M(C) Light-ON/Dark-ON

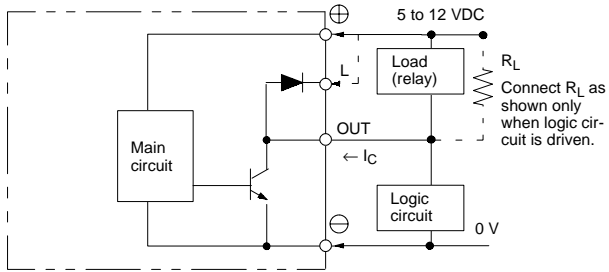

EE-SB5V(C), EE-SB5V-E Light-ON/Dark-ON

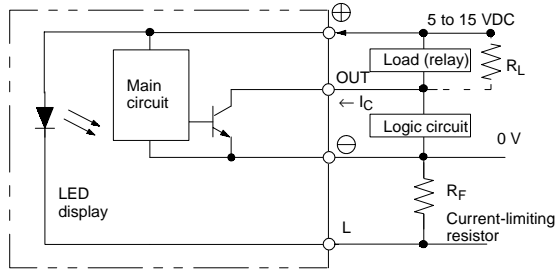

TIMING CHART

Light-ON

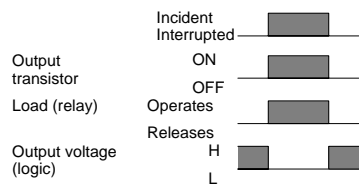

Dark-ON

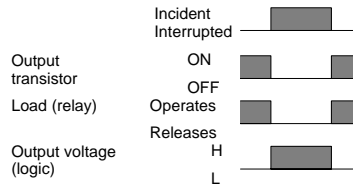

Dimensions

Unit: mm (inch)

EE-SB5M(C), EE-SB5V(C), EE-SB5V-E

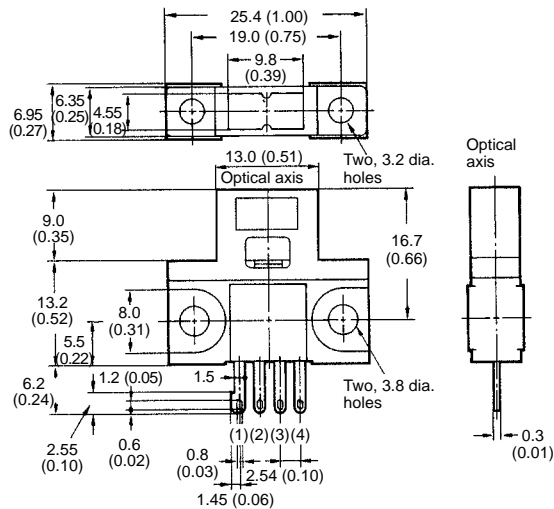

Terminal Arrangement

(1)	⊕	V _{CC}
(2)	L	L
(3)	OUT	OUTPUT
(4)	⊖	GND (0 V)

■ EE-SB5M(C)/SB5V(C)/SB5V-E + EE-1001

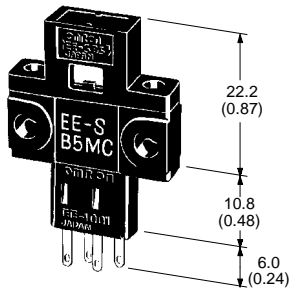

■ EE-SB5M(C)/SB5V(C)/SB5V + EE-1006

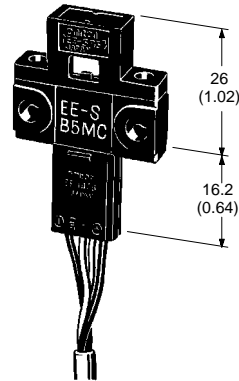

■ EE-1001 CONNECTOR

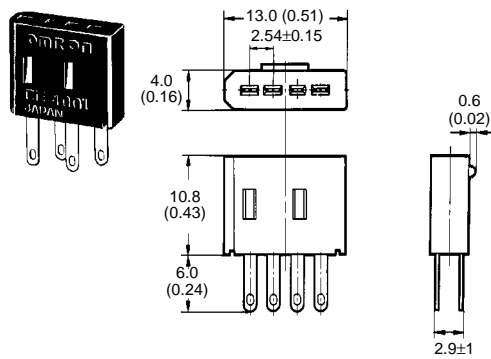

■ EE-1006 CONNECTOR WITH CABLE

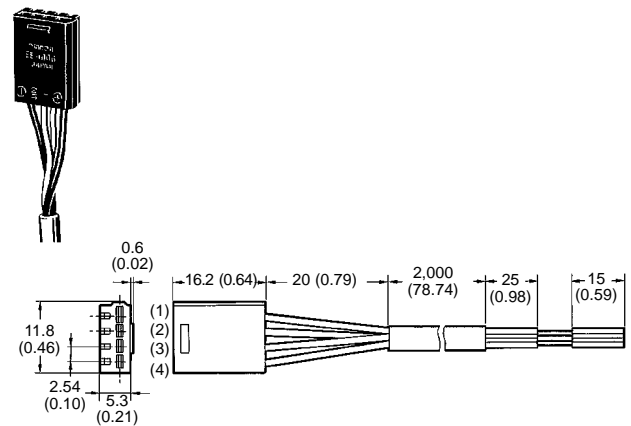

Terminal Arrangement

(1) Red (Brown)	⊕	V _{CC}
(2) Yellow (Pink)	L	L
(3) White (Black)	OUT	OUTPUT
(4) Black (Blue)	⊖	GND (0 V)

IEC colors are shown in parentheses.

Note: Supply 5 to 12 V to the EE-SB5M(C). Wire as shown by the following diagram if the supply voltage exceeds 12 V.

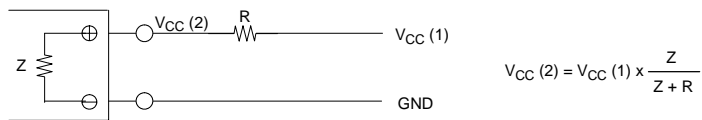

Note: Z is the internal impedance between the positive and negative terminals.

Model	V _{CC} (2)	Z (Ω)
EE-SB5M(C)	5 to 12 V	360

Precautions

Refer to the Technical Information Section for general precautions.

An external sensitivity adjuster can be connected to the EE-SB5V(C), EE-SB5V-E Photomicrosensor. When connecting the sensitivity adjuster, insert resistor R_F (current-limiting resistor), as shown by the diagram. The value of R_F is obtainable as follows:

$$R_F > (V_{CC} - 1.5 \text{ V})/30 \text{ mA}$$

Note: The EE-SB5V(C) and EE-SB5V-E have no constant current circuit to protect the LED. For this reason, the LED will be damaged by excessive current applied to the positive terminal. To prevent potential LED damage, connect a current-limiting resistor, as shown previously.

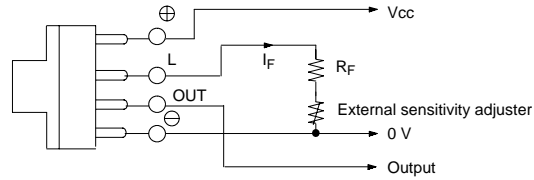

NOTE: DIMENSIONS SHOWN ARE IN MILLIMETERS. To convert millimeters to inches divide by 25.4.

OMRON[®]
OMRON ELECTRONICS, INC.
 One East Commerce Drive
 Schaumburg, IL 60173
1-800-55-OMRON

OMRON CANADA, INC.
 885 Milner Avenue
 Scarborough, Ontario M1B 5V8
416-286-6465