

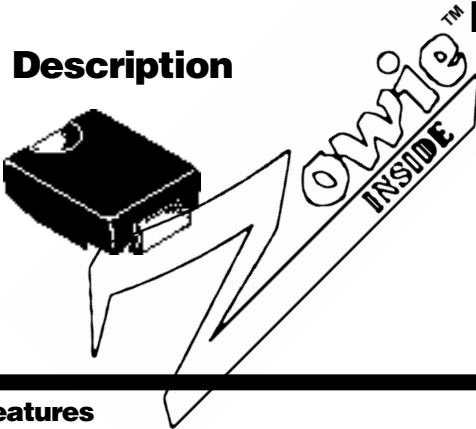

3.0 Amp Glass Passivated Sintered Fast Efficient Rectifiers

EGFZ30A . . . 30M Series

Description



Mechanical Dimensions

Package "SMC"

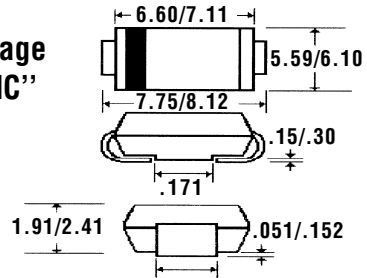

Features

- **LOWEST COST FOR GLASS SINTERED FAST EFFICIENT CONSTRUCTION**
- **LOWEST V_F FOR GLASS SINTERED FAST EFFICIENT CONSTRUCTION**
- **TYPICAL $I_r < 100$ nAmps**
- **3.0 AMP OPERATION @ $T_A = 55^\circ\text{C}$, WITH NO THERMAL RUNAWAY**
- **SINTERED GLASS CAVITY-FREE JUNCTION**

Electrical Characteristics @ 25°C.	EGFZ30A . . . 30M Series							Units
Maximum Ratings	30A	30B	30D	30G	30J	30K	30M	
Peak Repetitive Reverse Voltage... V_{RRM}	50	100	200	400	600	800	1000	Volts
RMS Reverse Voltage... $V_{R(rms)}$	35	70	140	280	420	560	700	Volts
DC Blocking Voltage... V_{DC}	50	100	200	400	600	800	1000	Volts
Average Forward Rectified Current... $I_{F(av)}$ Current 3/8" Lead Length @ $T_A = 55^\circ\text{C}$				3.0				Amps
Non-Repetitive Peak Forward Surge Current... I_{FSM} 8.3mS, 1/2 Sine Wave Superimposed on Rated Load				125				Amps
Forward Voltage @ 3.0A... V_F	< 1.0 >		1.3	< 1.7 >				Volts
DC Reverse Current... $I_{R(max)}$ @ Rated DC Blocking Voltage				5.0				μAmps
				100				
Typical Junction Capacitance... C_j (Note 1)				60				pF
Typical Thermal Resistance... $R_{\theta JA}$ (Note 2)				15				°C/W
Maximum Reverse Recovery Time... t_{RR} (Note 3)	< 50 >		< 75 >					nS
Operating & Storage Temperature Range... T_J, T_{STRG}	-65 to 150							°C



3.0 Amp Glass Passivated Sintered Fast Efficient Rectifiers

EGFZ30A . . . 30M Series

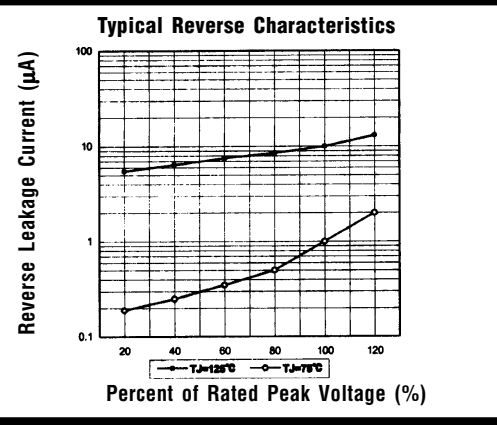
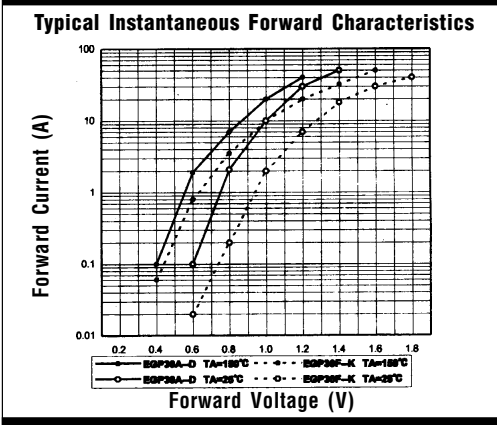
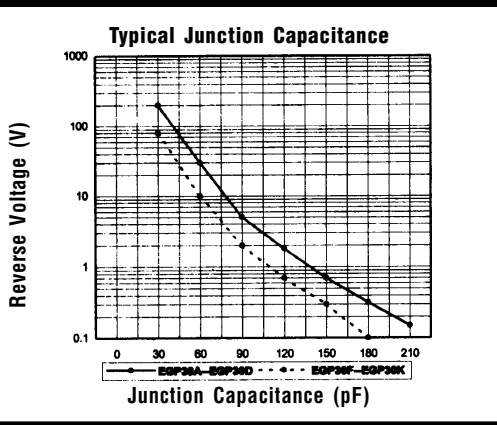
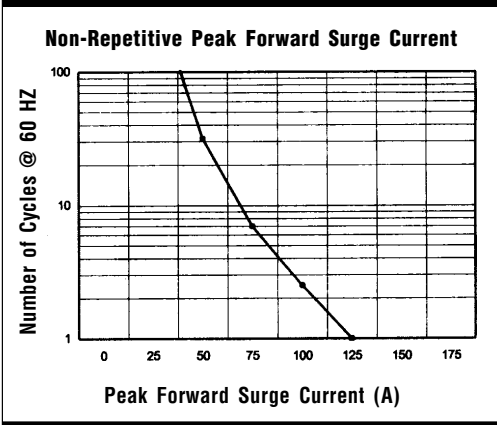
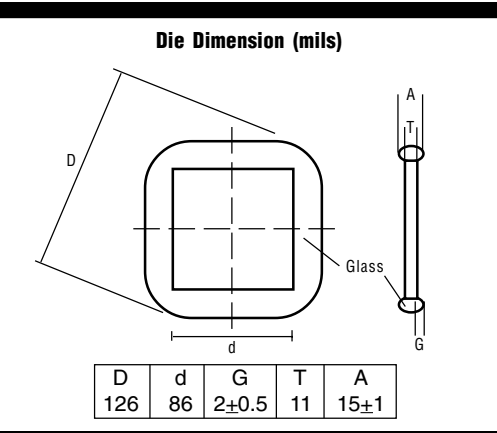
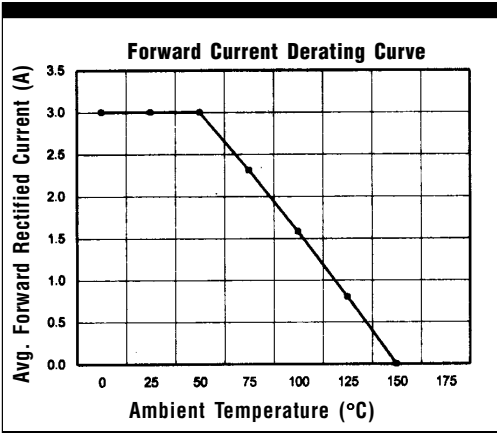

Ratings at 25 Deg. C ambient temperature unless otherwise specified.

Single Phase Half Wave, 60 HZ Resistive or Inductive Load.

For Capacitive Load, Derate Current by 20%.

- NOTES:**
1. Measured @ 1 MHz and applied reverse voltage of 4.0V.
 2. Thermal Resistance from Junction to Ambient at 3/8" Lead Length, P.C. Board Mounted.
 3. Reverse Recovery Condition $I_F = 0.5A$, $I_R = 1.0A$, $I_{RR} = 0.25A$.